

## **Chapter 4:**

### **General Methods of Plastic Analysis and Design**

Introduction

Load interaction method

Generalized hinge rotation method

Combination of mechanisms method

Method of inequalities

Analysis by adjustment of constraints

Plastic moment distribution method

Upper and lower bounds

---

### 4.1 Introduction

It has been seen that provided deflexions at collapse are not excessive, and the members do not fail by instability the collapse load of any frame is characterised by a bending moment distribution which satisfies the following conditions:

1. Equilibrium
2. Mechanism
3. Yield

For structures under proportional loading according to Uniqueness Theorem  $\lambda_c$  is unique, and can be found with considering deformations either at collapse, or any other stage of loading. For simple structure intuitive methods are already explained for finding exact  $\lambda_c$ . However, for complex structures, general methods are needed.

The safe and unsafe theorems will be used as the basis of the following methods:

- |  |   |   |
|--|---|---|
| Based on unsafe theorem<br>Equil. + Mech. C. | { | <ol style="list-style-type: none"> <li>1. Load Interaction Method</li> <li>2. Generalised Hinge Rotation Method</li> <li>3. Combination of elementary Mechanism Method</li> </ol> |
| Based on safe theorem<br>Equil. + Yield C.   | { | <ol style="list-style-type: none"> <li>1. Method of inequalities</li> <li>2. Adjustment of Restraints Method</li> <li>3. Plastic Moment Distribution Method</li> </ol>            |

In order to find the bounds, it may be necessary to use two types of methods. In both case Nos. 3 methods are suitable for hand calculation. Mathematical programming will later be used which is suitable for computers.

## 4.2 LOAD INTERACTION METHOD

This method is suitable only for structures for which all the mechanisms of failure can be explored without difficulty. Consider for example the following frame.

use work equation to find relationship between  $H$ ,  $W$  and  $M_p$  for each mode

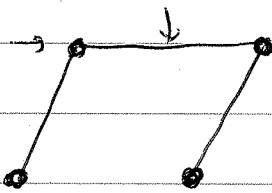
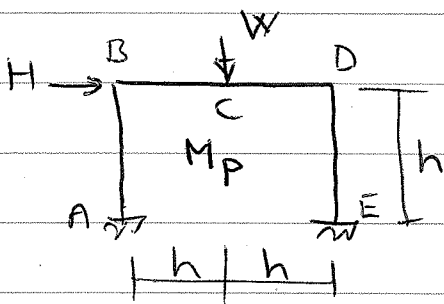

mode (a)  $H = 4M_p/h$

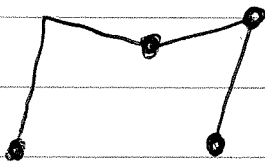

mode (b)  $H + W = 6M_p/h$

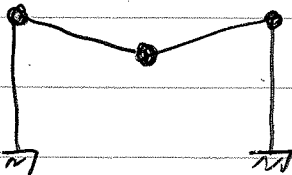

mode (c)  $W = 4M_p/h$

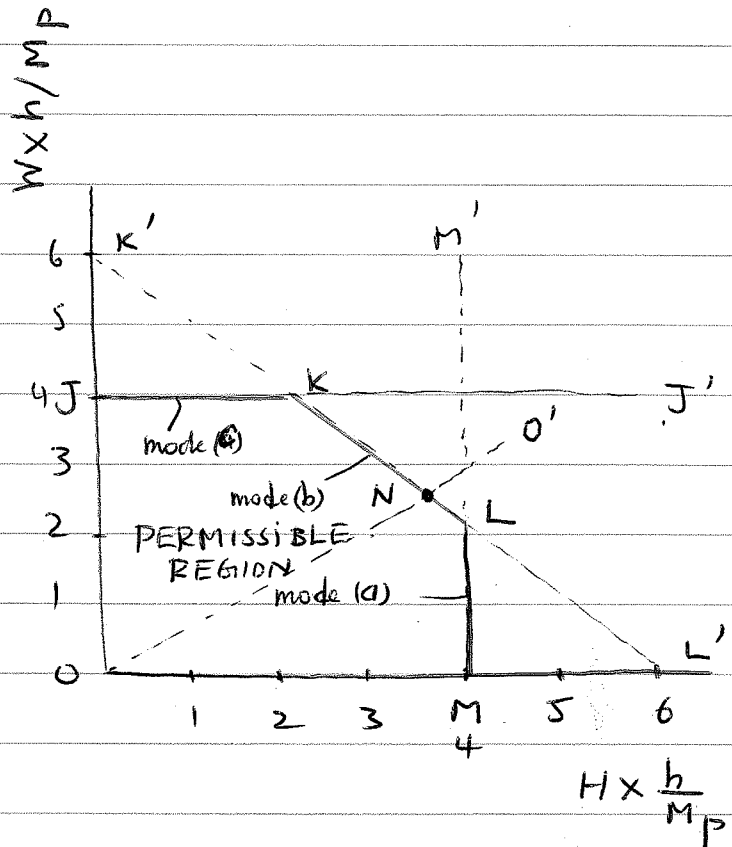

For each ratio of  $\frac{W}{H} = \mu$ , collapse occurs for the lowest load at which the line  $W = \mu H$  intersect any of the mechanism lines  $MM'$ ,  $K'L'$  or  $JJ'$ . For example, for  $W/H = 2/3$  collapse occurs at loads given by point N, whence  $H = 3.6 M_p/L$  and  $W = 2.4 M_p/L$  obtained from diagram, or solving  $\frac{W}{H} = \frac{2}{3}$ ,  $H + W = \frac{6M_p}{h}$ .

|| This method is valuable whenever it is desired to explore the effect of varying the ratio of intensity of two loads systems.

EXAMPLE 2

Full plastic moments are 50 and 80

The collapse modes

and corresponding collapse equation using work equation is as follows:

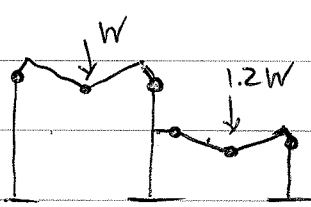
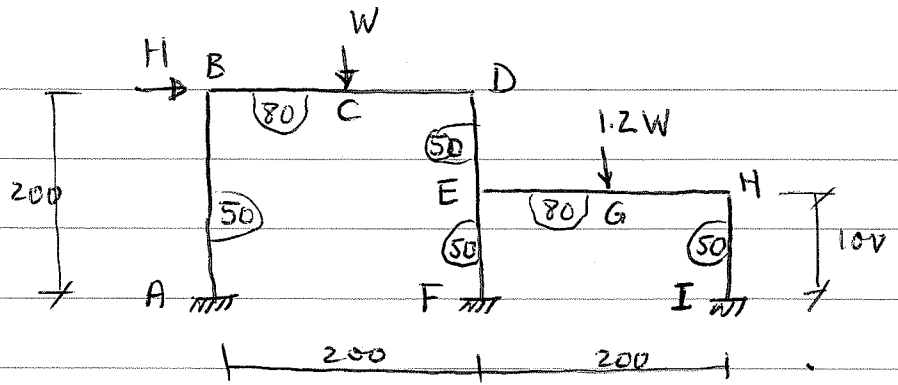

$W = 2.60$   $W = 2.42$   
Modes 1 and 2

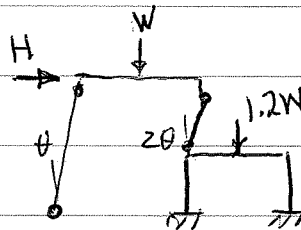

$H = 1.5$   
Mode 3

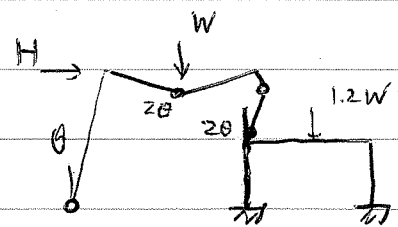

$2H + W = 4.60$   
Mode 4

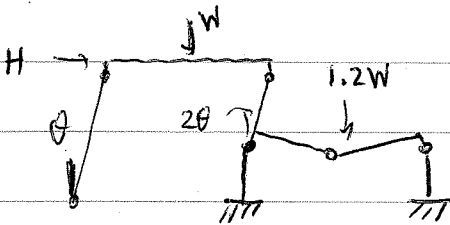

$5H + 6W = 18$   
Mode 5

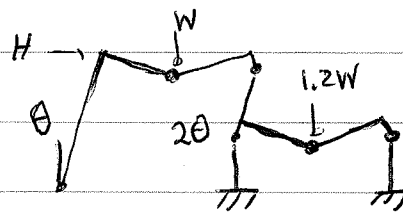

$H + 1.7W = 4.40$   
Mode 6

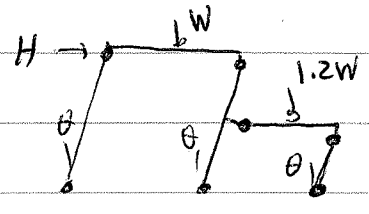

$H = 1.90$   
Mode 7

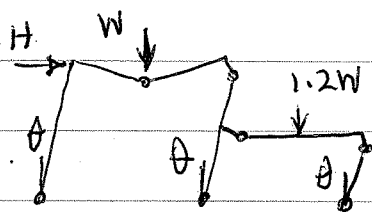

$2H + W = 5.4$   
Mode 8

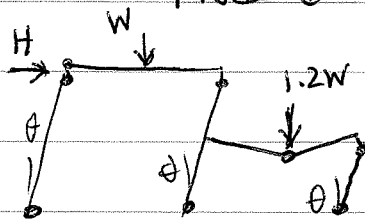

$2H + 1.2W = 5.1$   
Mode 9

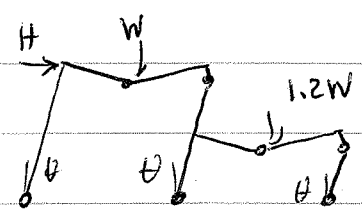

$H + 1.1W = 3.35$   
Mode 10

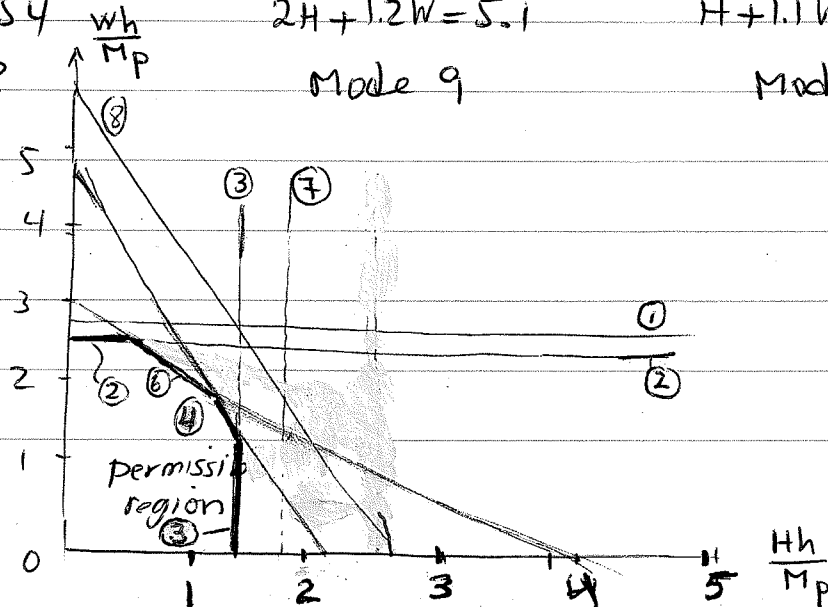

For distributed load, at least part of the boundary of the permissible region will be curved. Consider a portal frame with distributed load. Except mode 2

The other modes are similar and the interaction diagram is shown below. For details see steel skeleton (vol. 2) Baker et al.

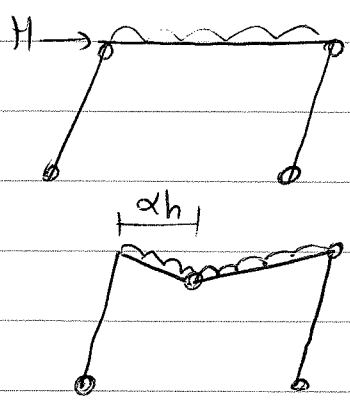
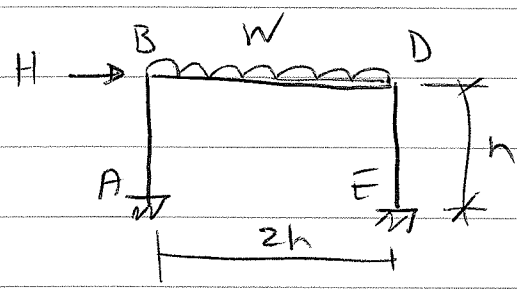

$\frac{Hh}{M_p} = 4$   
mode 1

$2\left(\frac{Hh}{M_p}\right) + \alpha\left(\frac{Wh}{M_p}\right) = 4 \left| \frac{4-\alpha}{2-\alpha} \right|$   
mode 2

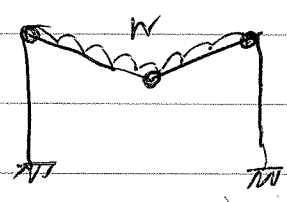

$\frac{Wh}{M_p} = 8$   
mode 3

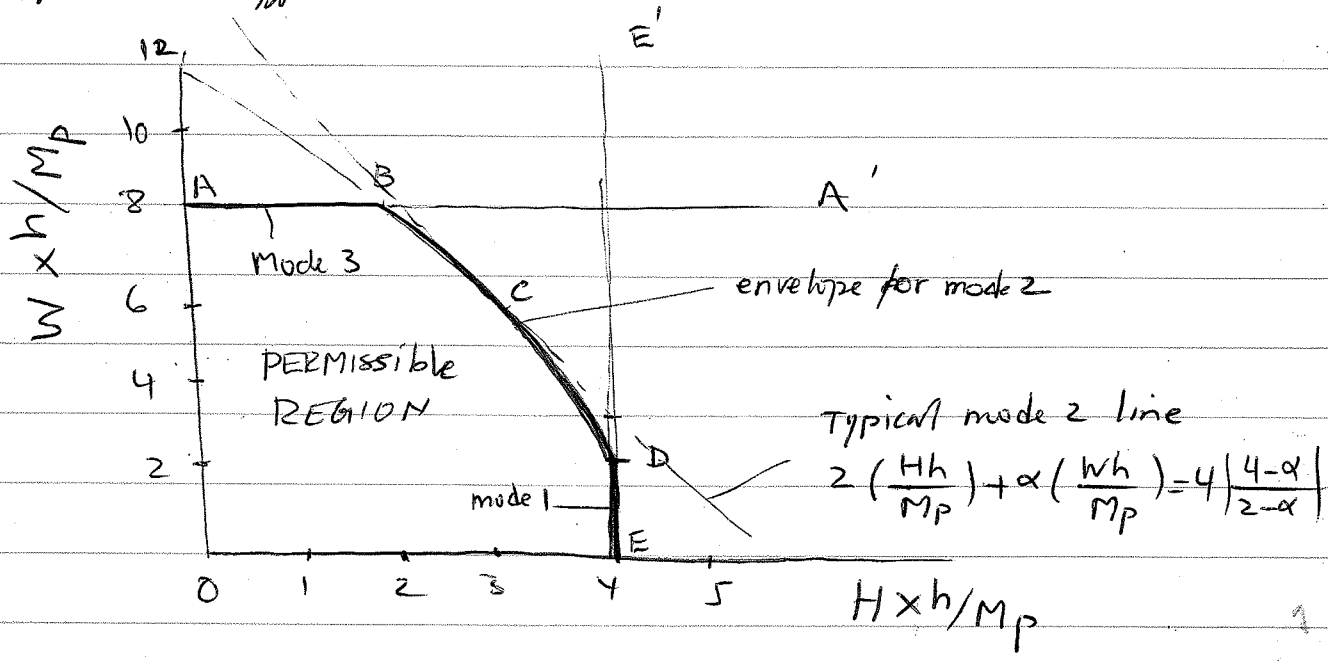

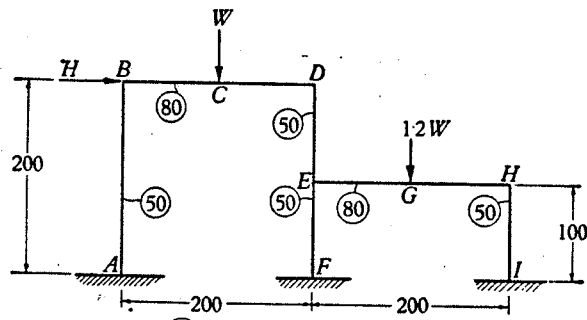

50 Full plastic moments  
 Loads and dimensions  
 (a)

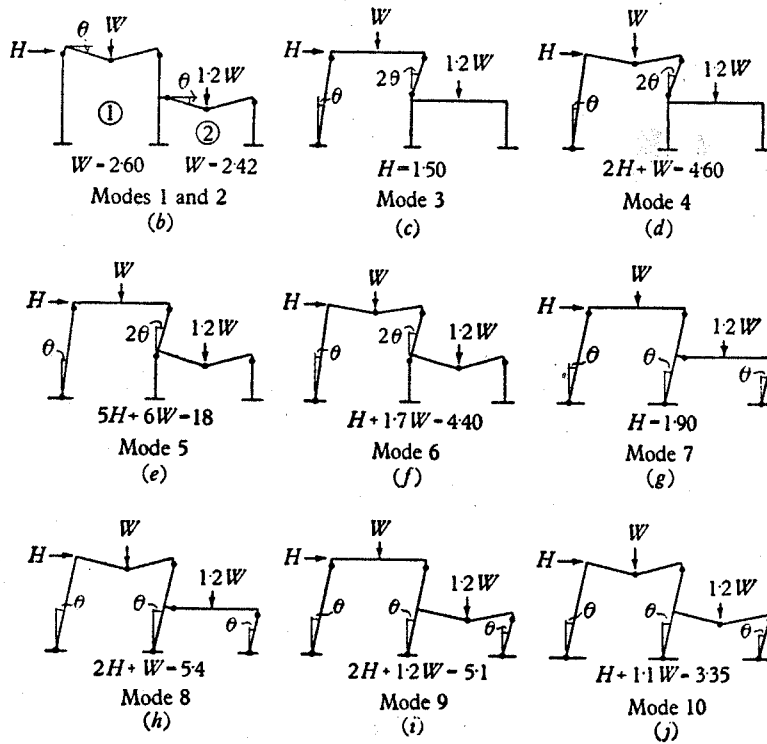

Fig. 8.2.

It should be noted that the boundary of the permissible region is in all cases necessarily concave towards the origin.

### 8.3. Analysis by generalized hinge rotation

The method of exploring all possible mechanisms described in §8.2 suffers from the disadvantage that the process by which the mechanisms are formulated is based on an intuitive approach only. Heyman and Nachbar (8.1) suggested that arbitrary hinge rotations should be imposed at each joint, under each concentrated

load, and at arbitrary positions under distributed loads, and these arbitrary rotations and positions should be adjusted so that the load factor obtained from the corresponding virtual work equation was a minimum. The method may be illustrated by reference to the simply supported two-span beam shown in fig. 8.5(8.2). The full plastic moment is the same in both spans and of value  $M_p$ .

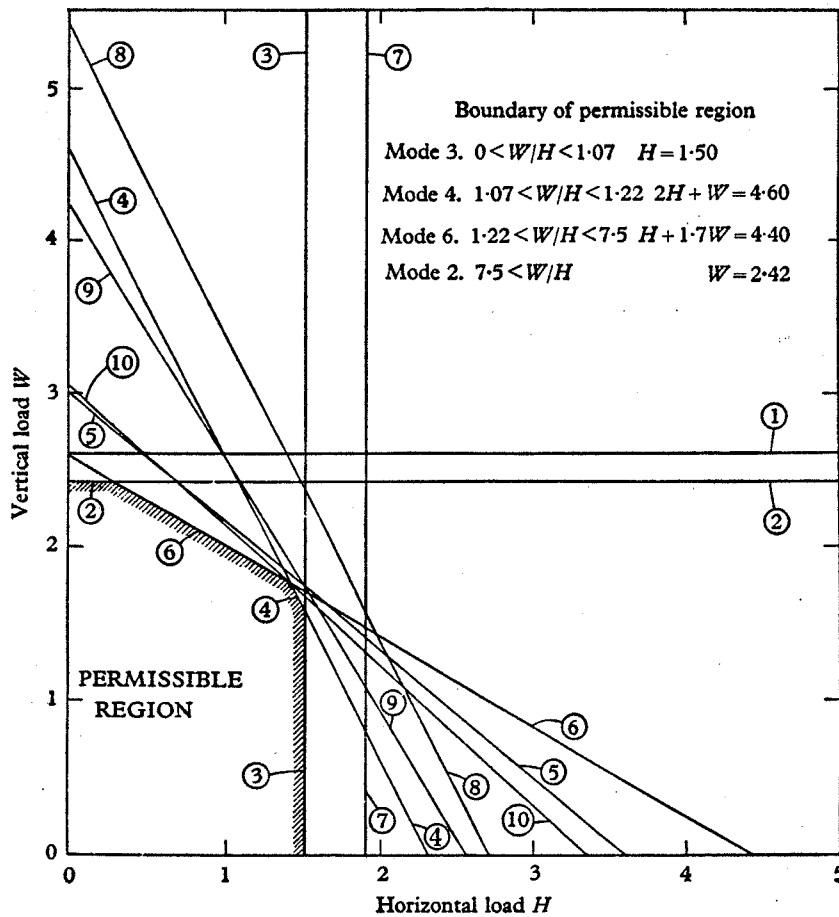

Fig. 8.3.

Hinges are inserted under the loads at  $B$  and  $D$  and over the support at  $C$ . Thus arbitrary rotations  $\theta_1$  and  $\theta_2$  may be postulated as shown. The work equation is

$$2W \frac{l}{2} \theta_1 + W \frac{l}{2} \theta_2 = M_p \left\{ |2\theta_1| + |\theta_1 + \theta_2| + |2\theta_2| \right\},$$

i.e. 
$$W = \frac{2M_p}{l} \frac{|2\theta_1| + |\theta_1 + \theta_2| + |2\theta_2|}{2\theta_1 + \theta_2}. \quad (8.1)$$

Arbitrary values may be assumed for the ratio  $\theta_2/\theta_1$  ( $\theta_1$  assumed positive), and the corresponding value of  $W$  calculated, with the result shown graphically in

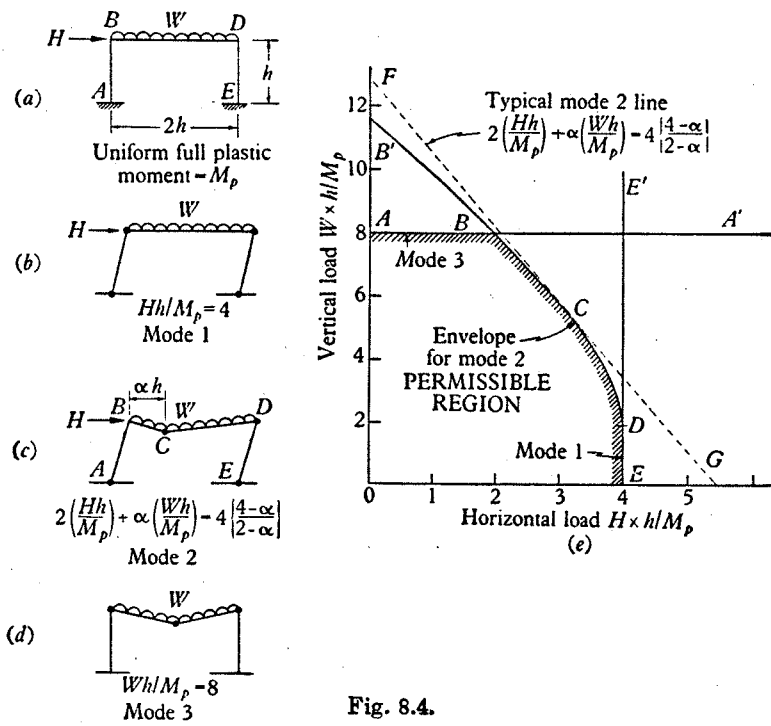

Fig. 8.4.

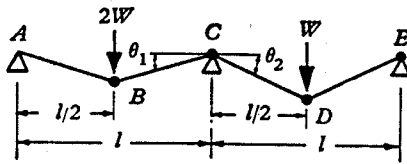

Fig. 8.5.

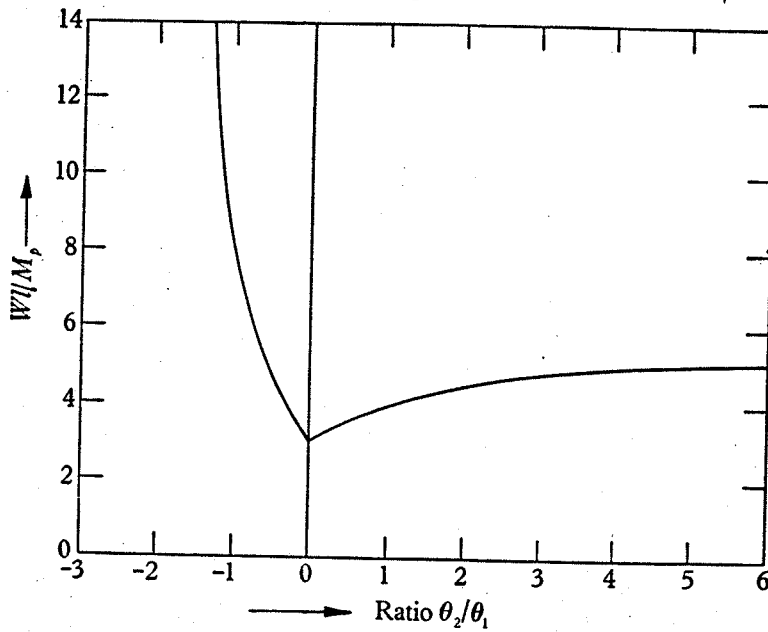

Fig. 8.6.



### 4.3 GENERALISED HINGE ROTATION METHOD

This method is suggested by Heyman and Nachbar in which arbitrary hinge rotations are imposed at each joint, under each concentrated load, and at arbitrary positions under distributed loads, and these arbitrary rotations and positions are adjusted so that the load factor obtained from the corresponding virtual work equation becomes a minimum.

EXAMPLE: Consider a two span uniform beam.

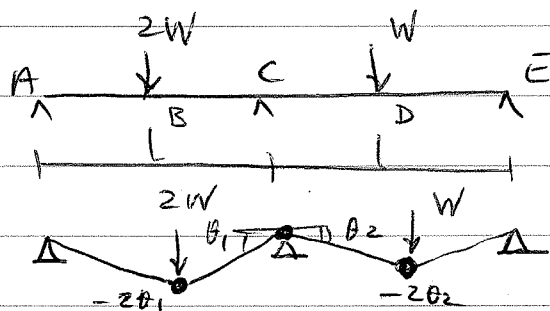

Hinges are inserted at B and D and over the support C. Thus arbitrary rotations  $\theta_1$  and  $\theta_2$  may be postulated as shown. From work equation

$$2W \frac{L}{2} \theta_1 + W \frac{L}{2} \theta_2 = M_p \{ |2\theta_1| + |\theta_1 + \theta_2| + |2\theta_2| \}$$

i.e. 
$$W = \frac{2M_p}{L} \frac{|2\theta_1| + |\theta_1 + \theta_2| + |2\theta_2|}{2\theta_1 + \theta_2}$$

For different values of  $\frac{\theta_2}{\theta_1}$  the variation of  $W$  is shown. Minimum value of  $W$  occurs when  $\theta_2/\theta_1 = 0$  i.e.  $\theta_2 = 0, \theta_1 \neq 0$ . Hence the correct mode of collapse is as shown with

$$W = 3M_p/L$$

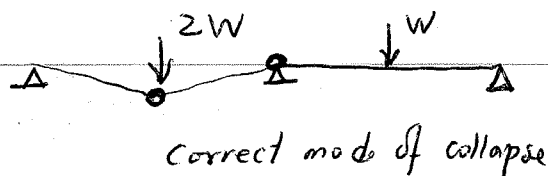
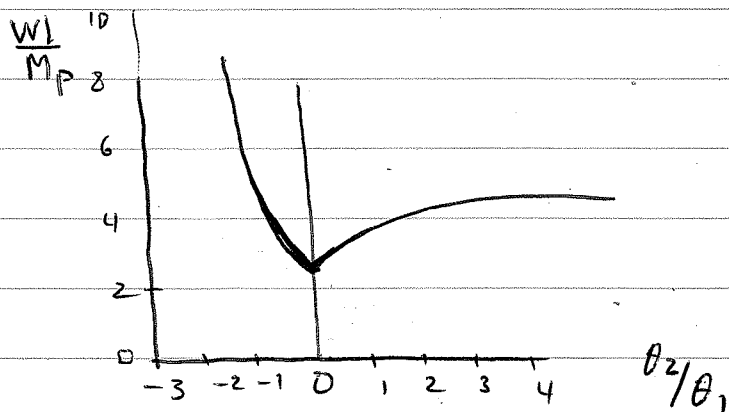

Correct mode of collapse

### 4.4 COMBINATION OF MECHANISMS METHOD

This method is due to Neal and Symonds and will be introduced by reference to some examples

Consider a portal frame as shown and its collapse modes.

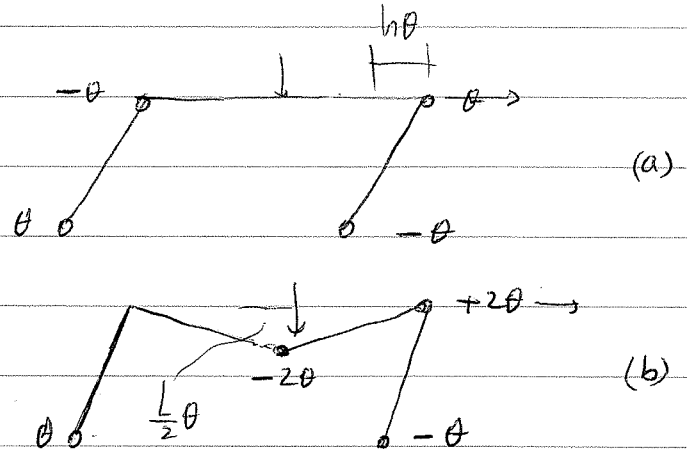
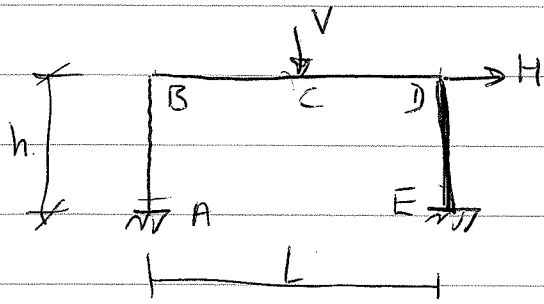

From V. Work for mode (a)

$$Hh = M_A - M_B + M_D - M_E \quad (4.1)$$

This equation can also be obtained by shear balance.

Equation (4.1) should be satisfied whether frame is elastic or plastic.

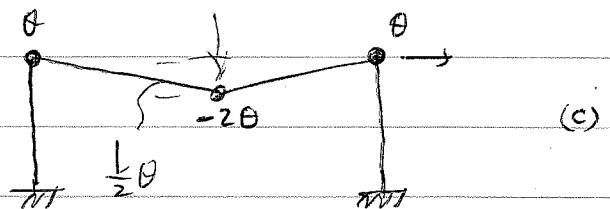

Denote moments at A, B, C, D, E by  $M_A, M_B, M_C, M_D$  and  $M_E$ . These five sections are called "critical sections" at which plastic hinges might form under the particular loading system. If moments at critical sections are known the B.M. of structure can be drawn. These sections are also known as "cardinal sections".

For this frame  $\gamma(S) = 3$ . i.e. If 3 moments e.g.  $M_A, M_B$  and  $M_D$  are known then  $M_E$  can be calculated from Eq. (4.1)

Now consider the ~~third~~ <sup>mode</sup> mechanism and from v. work

$$\frac{1}{2}VL = M_B - 2M_C + M_D \quad (4.2)$$

(This can also be found considering the equilibrium of the beam BCD)

The third mechanism, second mode, yields

$$Hh + \frac{1}{2}VL = M_A - 2M_C + 2M_D - M_E \quad (4.3)$$

This equation is dependent on the previous equations and does not give additional information. One can see that it is obtainable by adding (4.1) and (4.2).

Thus if a frame has  $N$  critical sections and the number of indeterminacy is  $R$ , then  $(N-R)$  independent relationship between the values of the bending moments at critical section exists, i.e. there exists  $(N-R)$  independent mechanisms of collapse. All other mechanisms of collapse can be deduced from  $(N-R)$  independent mechanisms.

Similar to Equations

$$(4.1) + (4.2) \rightarrow (4.3)$$

$$\text{mechanism (a)} + \text{mech. (c)} \rightarrow \text{mech (b)}$$

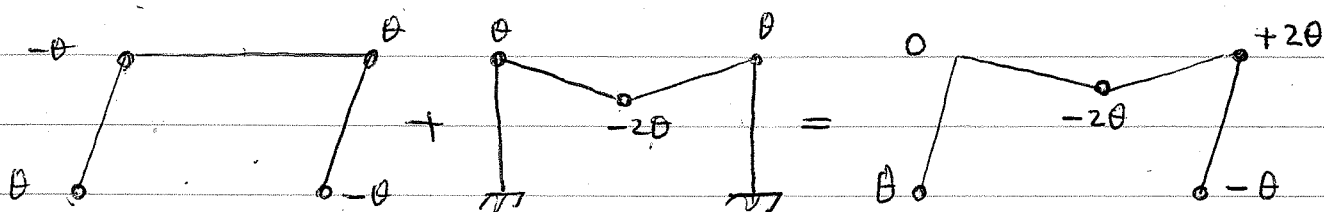

You can see that hinge B is cancelled. This will be discussed in later stages.

Eq (4.1) and (4.2) are written in general term, however they can be simplified for plastic case as

$$Hh = 4M_p \quad \frac{1}{2}VL = 4M_p \quad (4.4)$$

By addition for mech. (b) we have

$$Hh + \frac{1}{2}VL = 6M_p$$



NOTE: Cancellation of hinge is essential, otherwise adding ~~the~~ equations never leads to a  $\Delta$  better than both of them (it lead to an intermediate value)

FOR PROOF OF EXISTANCE OF A HINGE CANCELLATION SEE P. 149 Baker Heyman

EXAMPLE: consider a portal as loaded and solve it by combined mechanism technique.

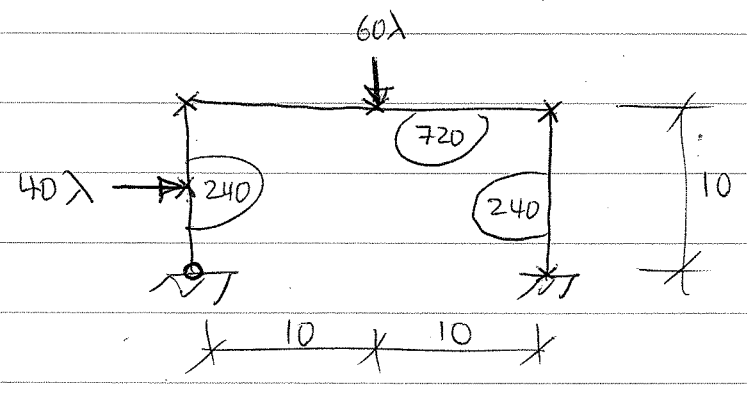

critical sections are marked by x at five points. Frame is indeterminate by  $R=2$  thus  $5-2=3$  independent mechanisms should exist.

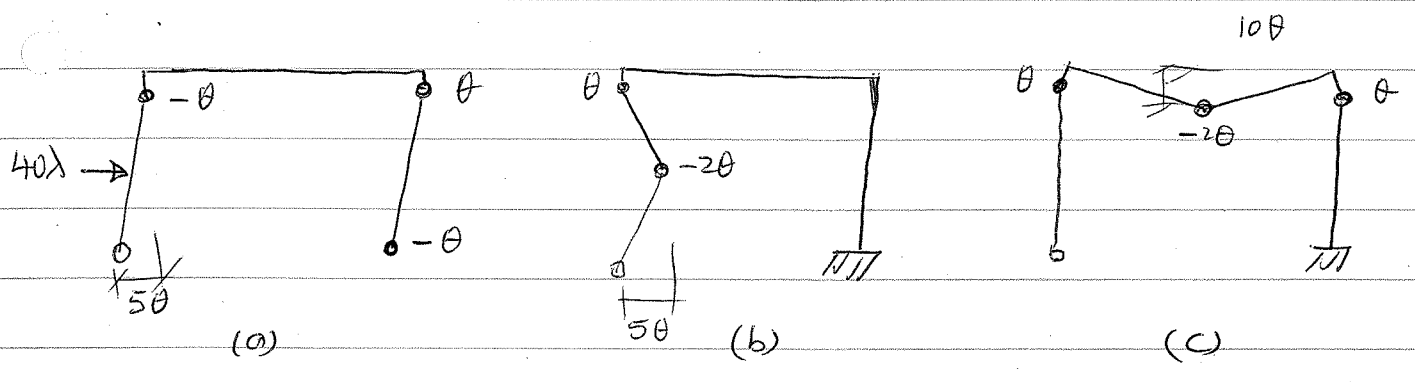

(a)	$200\lambda = 720$	$\lambda = 3.6$	} (4.11)
(b)	$200\lambda = 720$	$\lambda = 3.6$	
(c)	$600\lambda = 1920$	$\lambda = 3.2$	

Let us consider the combinations

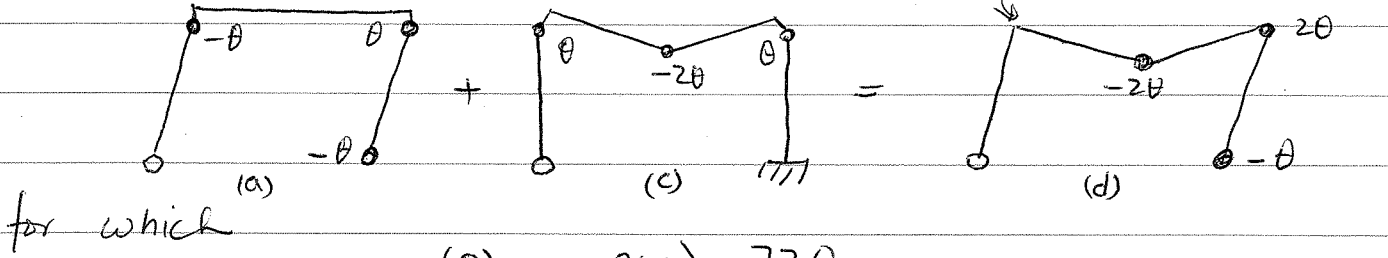

for which

$$\begin{aligned} (a) \quad 200\lambda &= 720 \\ (c) \quad 600\lambda &= 1920 \\ \hline 800\lambda &= 2640 \end{aligned}$$

cancel hinge  $-2(240)$

$$800\lambda = 2160 \quad ; \quad \lambda = 2.7$$

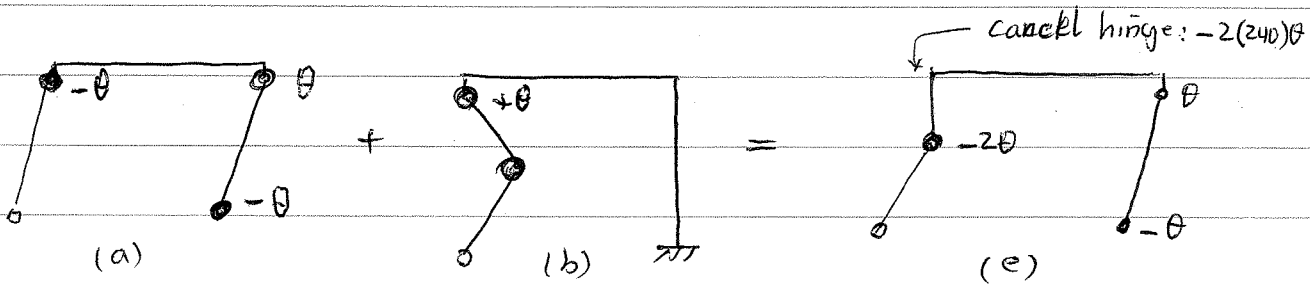

$$\begin{aligned} (a) \quad 200\lambda &= 720 \\ (b) \quad 200\lambda &= 720 \\ \hline 400\lambda &= 1440 \end{aligned}$$

cancel hinge  $-2(240)$

$$400\lambda = 960$$

$\lambda = 2.4$  final answer

There are some unreasonable mechanism obtained as

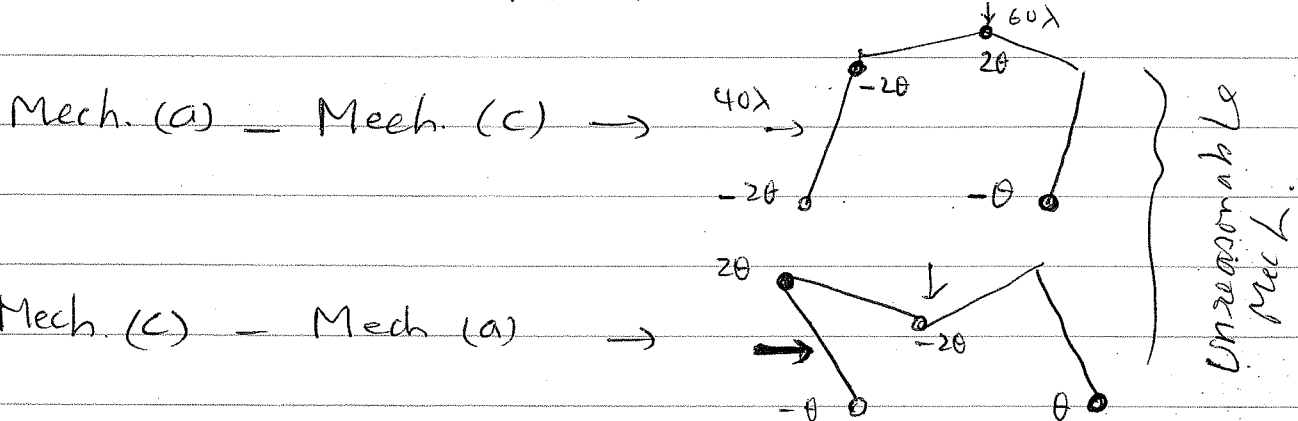

Thus the final answer is Mech. (e) with  $\lambda = 2.4$

and as before statical control should be made to make sure that the yield condition is not violated.

### 4.4.1 JOINT ROTATIONS

consider a portal frame.  
 Hinge at junction happens in weaker element i.e. beam or column. Although for uniform cross section hinges were shown at junction, however, it should happen in one of the members.

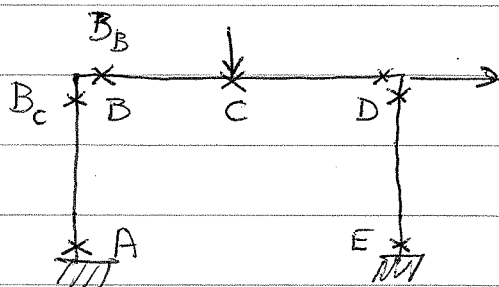

Therefore seven critical sections are considered, since  $\delta(S) = 3 - R$ , thus  $7 - 3 = 4$  independent mechanisms are required to describe completely the behaviour of the frame.

- one sway mechanism
- one beam mechanism
- two joint rotations

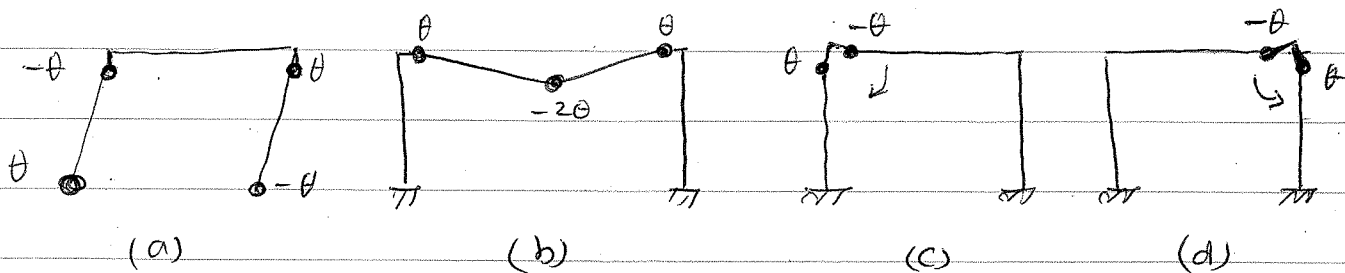

The meaning of the mechanism (c): with writing equilibrium

$$(M_{Bc})(\theta) + (M_{B_B})(-\theta) = 0$$

$$M_{Bc} = M_{B_B}$$

This equation states that no more than that: "moment at knee B of the frame is continuous round the corner."

|| joint rotations are important in locking together the elementary mechanisms.

# Applications of joint rotations.

consider a portal, combine mode (a) and (b) as shown

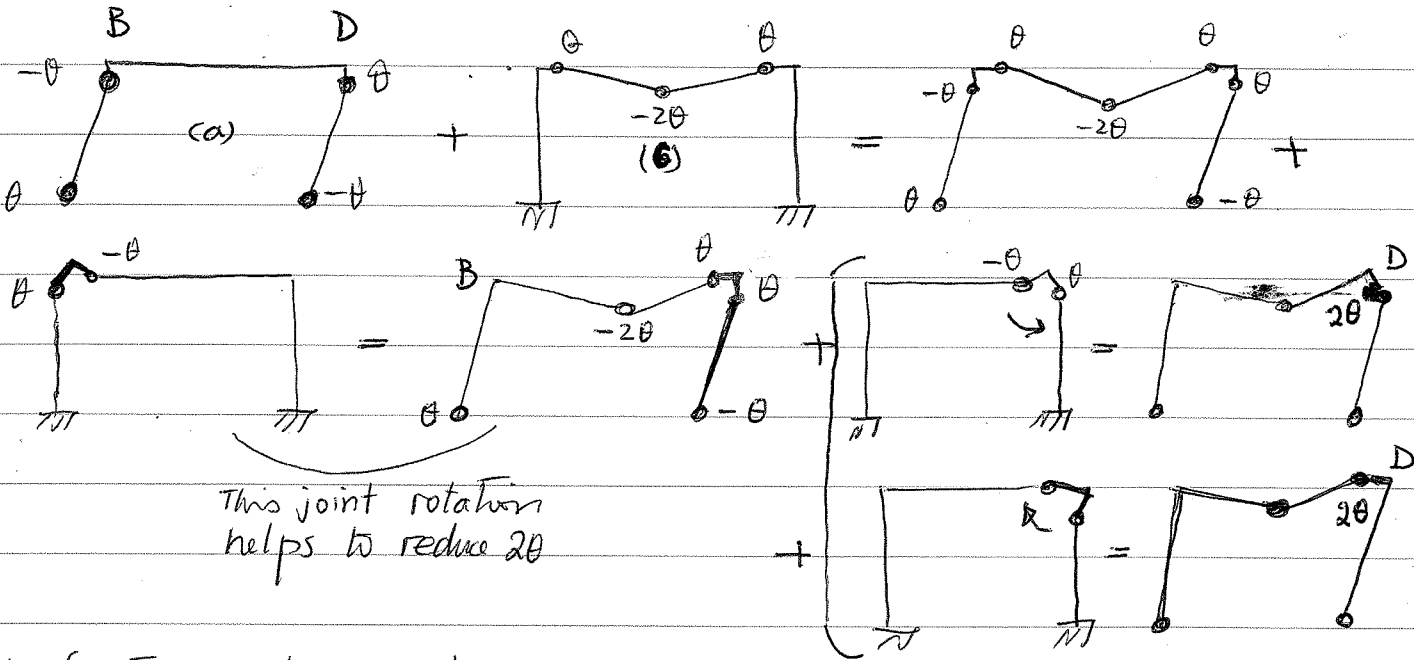

and further add joint rotations for possible reduction like  $(2\theta)M_p$  in collapse equation. Joint rotation at B helps, but at D helps only when cross-sections are non-uniform, as illustrated.

This joint rotation does not help unless sections are non uniform and changing hinge from beam to column or column to beam helps



## Number of Elementary Mechanisms

In a structure there are  $N$  points in which a plastic hinge could form. The BMD at collapse can be drawn if the BM is known at each of these points, so there are  $N$  unknowns. Each of the  $m$  elementary mechanisms can be thought of as an independent equation relating moments at the hinge points to the applied loading. (independent equilibrium equations) Since there are  $N$  unknowns and  $m$  equations to find them

$$N - m = R \quad (\text{definition of DSI})$$

where  $R$  is the DSI of the frame.

$N$  can be found by simple counting,  $R$  by formula and the number of elementary mechanisms

$$m = N - R$$

Example:

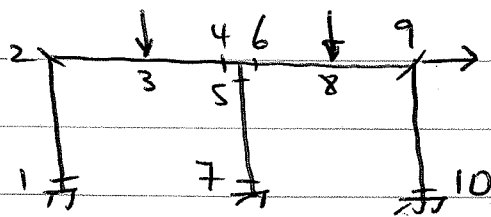

$$m = 10 - 2 \times 3 = 4$$

Two beam mechanisms and a sway mech. and one joint rotation mech.

## 4.4.2 MULTI-STOUREY MULTI-BAY FRAMES

Consider a two-storey single bay frame as shown which has a uniform cross-section.

For upper joints only one critical section is considered, however, for lower one, 3 critical sections since plastic hinge can be formed on beam or column ends, The bending moments at each group of such critical section must sum to zero.

The following joint rotations will furnish the corresponding equilibrium equations.

For this frame

$$R = 3 \times 2 = 6$$

$$N = 12$$

$$(N - R) = 12 - 6 = 6$$

- 2 joint rotations

4 independent Mech.

If 2 critical section is consider at top joints then

$$N = 14$$

$$(N - R) = 14 - 6 = 8$$

- 4 joint rotations

4 independent Mech.

The following four simple Mechanisms can be taken as 4 independent ones.

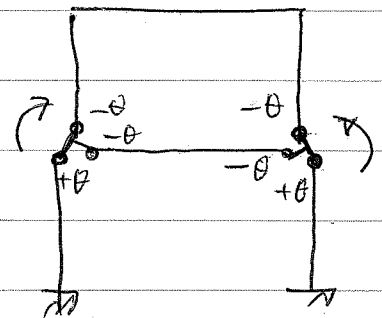
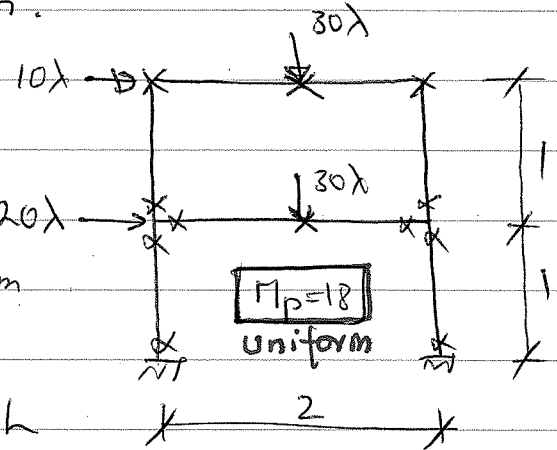

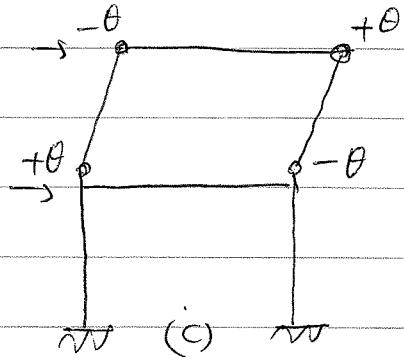
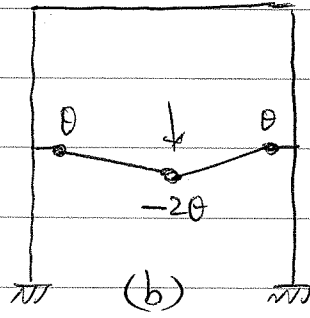
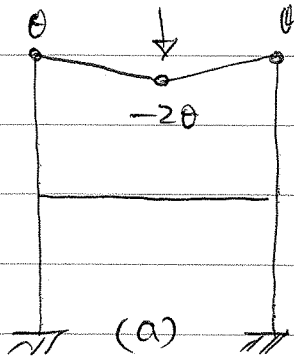

Beam Mechs. are local and  
Sway Mechs. are overall collapses

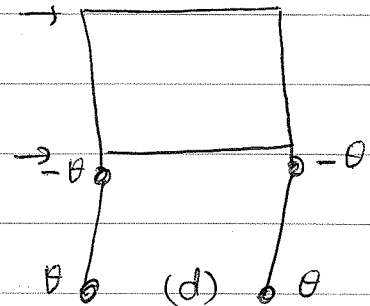

One can consider also other mechanisms as basic.  
As an example, in place of (d) one can use (c)+(d)  
as shown. However, it is better to use simpler mechanisms.

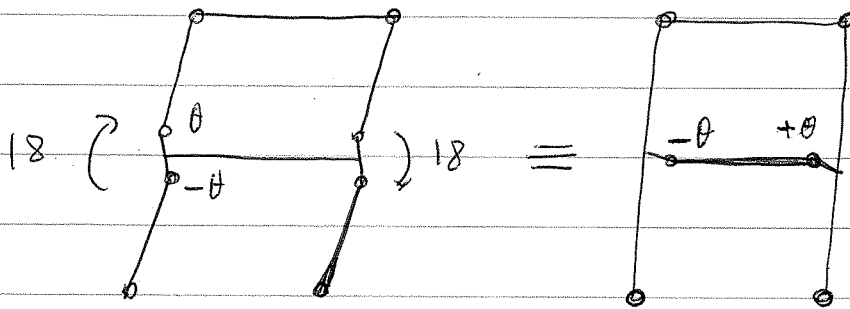

(e) = (c) + (d)

For the previous 4 Mechanisms we have

(a)	$30\lambda = 72$	$\lambda = 2.4$	}
(b)	$30\lambda = 72$	$\lambda = 2.4$	
(c)	$10\lambda = 72$	$\lambda = 7.2$	
(d)	$30\lambda = 72$	$\lambda = 2.4$	

NOW the combinations together with joint rotations;  
combining is arbitrary, however, it is sensible

to start with those elementary mechanisms which give the lowest value of  $\lambda$ .

We start with (c) + (d)

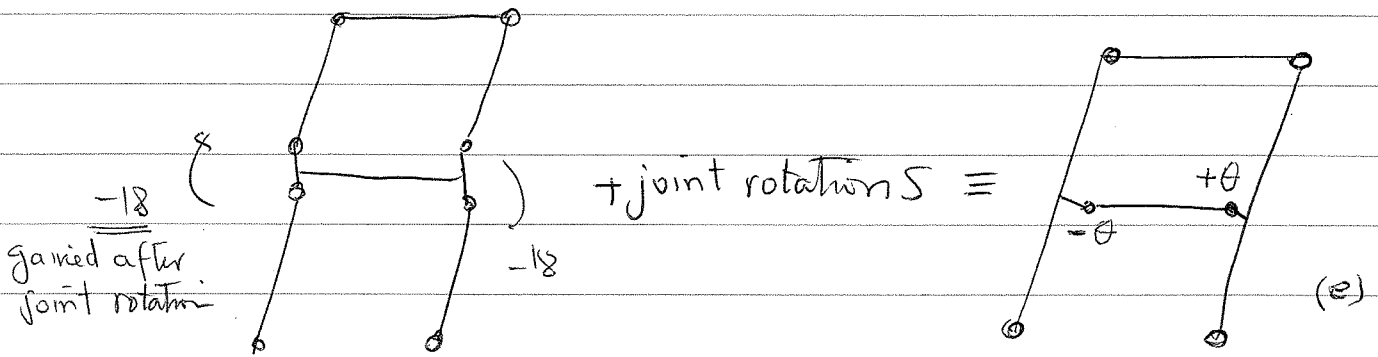

joint rotation at each junction one gain  $M_p(2\theta)$  but loses  $M_p(\theta)$ . Thus  $M_p(\theta)$  is gained which equal to 18  
Thus

(c)  $10\lambda = 72$   $\lambda = 7.2$

(d)  $30\lambda = 72$   $\lambda = 2.4$

$40\lambda = 144$

$2 \times 18 = 36$

Rotate joints

(e)  $40\lambda = 108$   $\lambda = 2.7$

which is worse than the strong of the lower storey, however, there is now possibility of adding beam mechanisms, with cancellation of hinges (reducing  $(2\theta)(M_p) = 36$ ).  
Two stages are shown

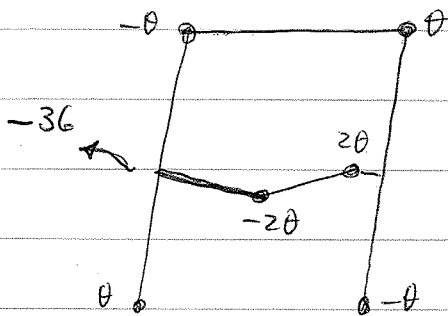

(f) = (e) + (b)

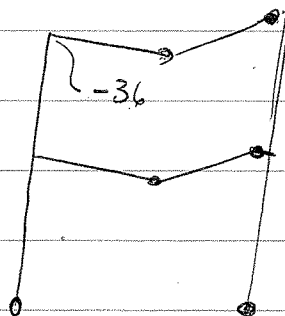

(g) = (f) + (a)

(e)  $40\lambda = 108 \quad \lambda = 2.7$

(b)  $30\lambda = 72$   
 $\underline{70\lambda \quad 180}$   
 $36$

cancel hinge

(f)  $70\lambda = 144 \quad \lambda = 2.06$

(a)  $30\lambda = 72$   
 $\underline{100\lambda \quad 216}$   
 $36$

cancel hinge

(g)  $100\lambda = 180 \quad \lambda = 1.80$

This is the lowest volume up to now.

### ORDER'S EFFECT

We combine the <sup>same</sup> mechs in different order and we will see that we get the same results

(b)  $30\lambda = 72$

(d)  $30\lambda = 72$   
 $\underline{60\lambda \quad 144}$   
 $18$

rotate joint

(h)  $60\lambda = 126 \quad \lambda = 2.10$

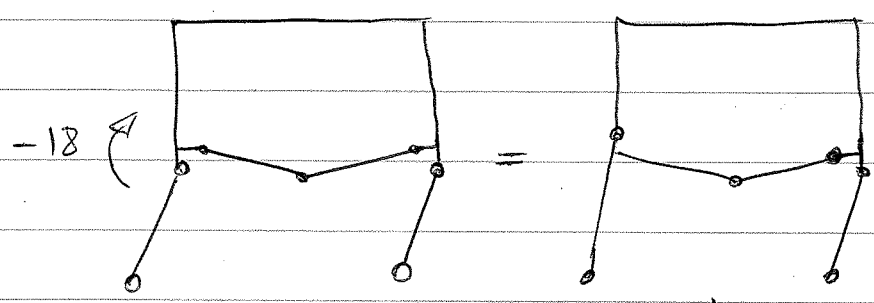

(h) = (b) + (d)

(h)  $60\lambda = 126$

(c)  $10\lambda = 72$   
 $\underline{70\lambda \quad 198}$   
 $36$

cancel hinge

$\underline{70\lambda \quad 162}$   
 $18$

rotate joint

(f)  $70\lambda = 144 \quad \lambda = 2.06$

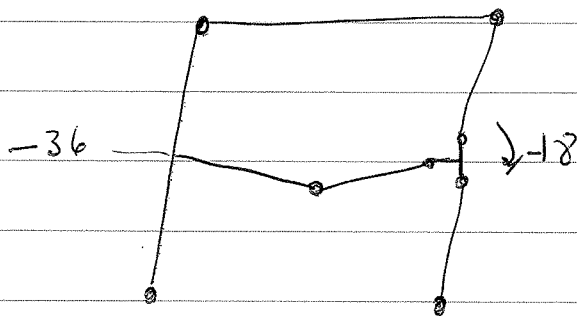

(f) = (h) + (c)

(f)  $70\lambda = 144$        $\lambda = 2.06$

(a)  $30\lambda = 72$

$100\lambda = 216$

$36$

(g)  $100\lambda = 180$        $\lambda = 1.80$

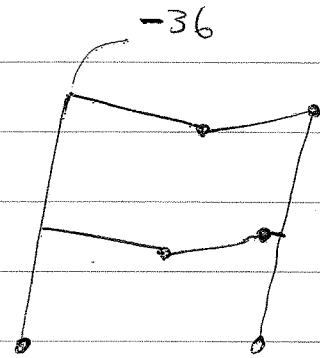

(g) = (f) + (a)

The state of frame at  $\lambda = 1.80$  is shown below

Now the difficulty:

6 hinges are formed

and  $\chi(S) = 6$ . Thus

collapse has happened

while the structure is once

indeterminate.

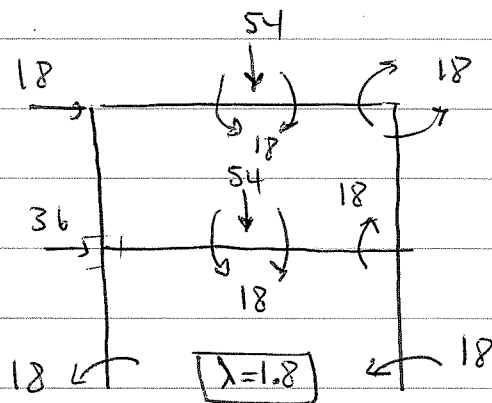

considering the equilibrium of members and shear leads to

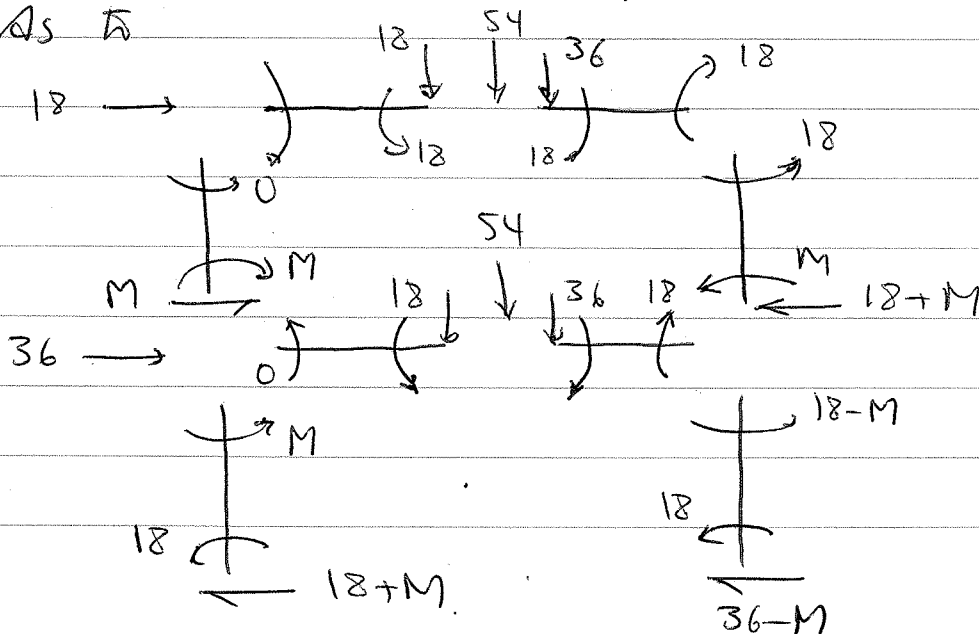

If  $M$  is between 0 and 18 then yield condition is also satisfied.

EXAMPLE 2:

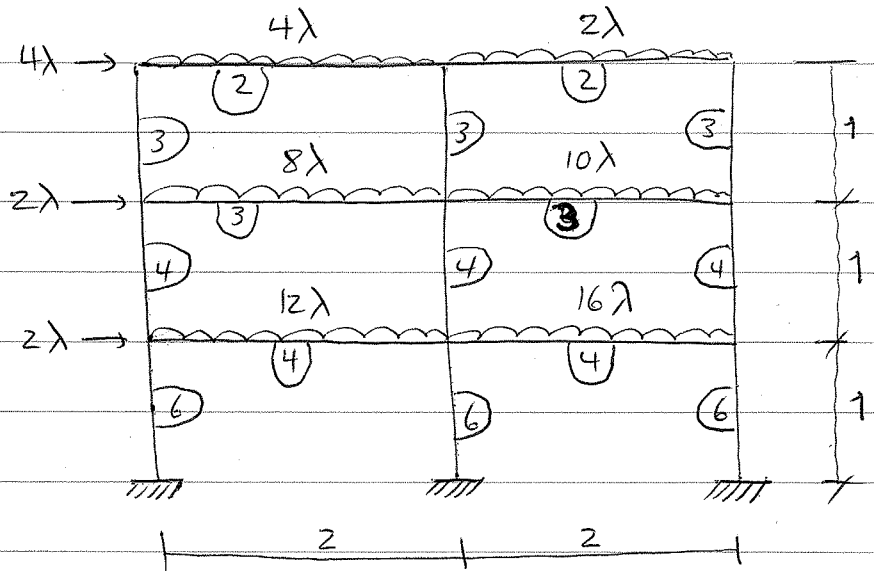

Distributed load will be considered later, for the time being in the preliminary analysis, a close estimate of the collapse load factor will be obtained if only a single critical section is taken at the centre of length of each beam.

The max free B.M. for a simply supported beam with uniform load is  $\frac{WL}{8}$ ; the corresponding value for a central point load is  $\frac{WL}{4}$ .

Thus each uniformly distributed load is replaced by an equivalent central point load of half the value to give the same free B.M. at the central cross section.

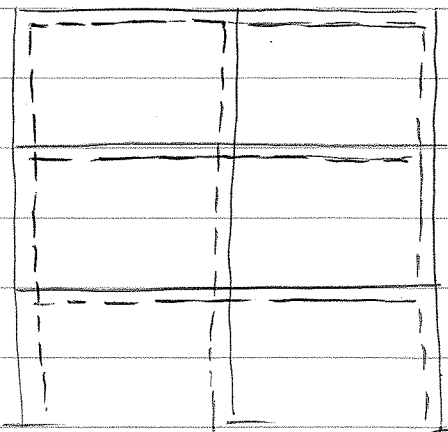
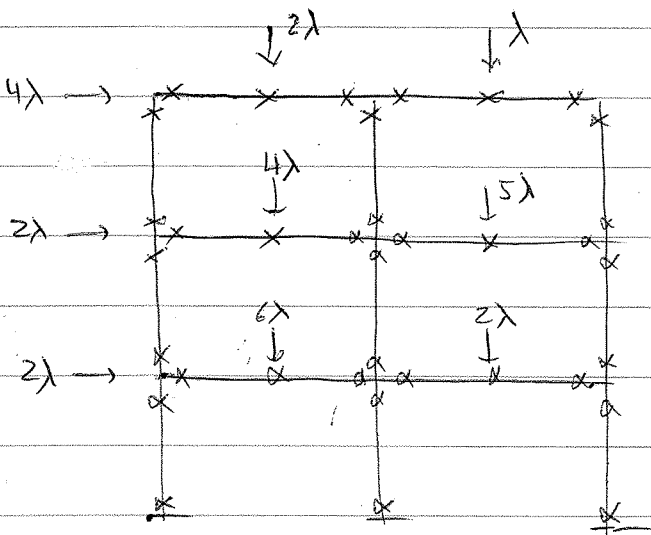
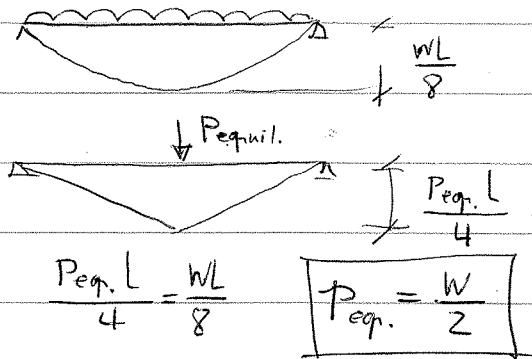

$N = 36$  critical sections

$R = 3 \times 6 = 18$

$(N - R) = 36 - 18 = 18$

Sign convention

SIGN CONVENTION: As before, bending moments producing compression on faces of members adjacent to the broken lines will be denoted positive.

	For our example (2x3)	For a frame with <u>m bays</u> and <u>n stories</u>
Critical sections	36	$[5mn + 2n]$
redundancies	18	$[3mn]$
independent Mechanisms	18	$[2n(m+1)]$
Joints	9	$[n(m+1)]$
True mechanisms	9	$[nm \text{ beams} + n \text{ sways}]$

The 9 mechanisms consisting 6 beam mechs and 3 sway mechs are shown below.

For each beam 3 hinges  $\therefore 3mn$  For each column 2 hinges  $\therefore$

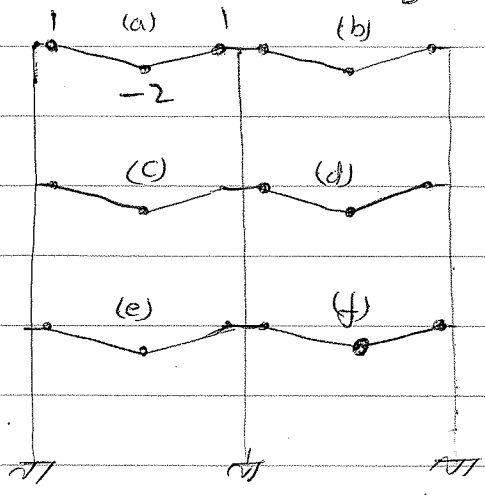

Six beam mechanisms

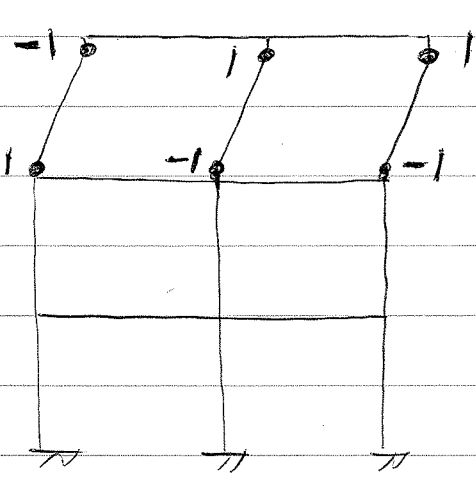

(g)

$2n(m+1)$   
Thus  
 $5mn + 2n$

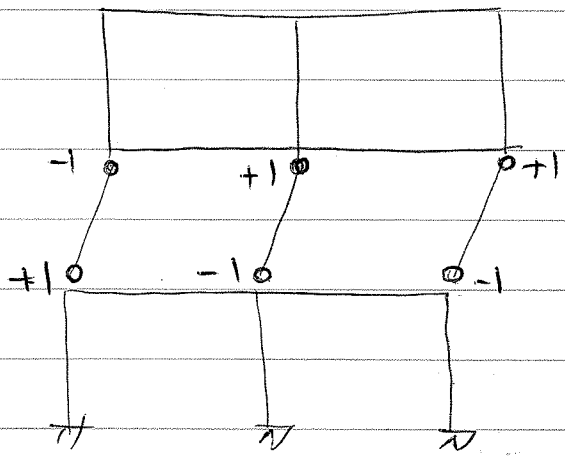

(h)

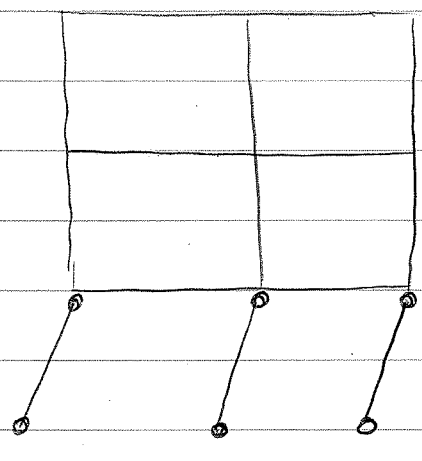

(j)



- (a)  $2\lambda = 8$  ,  $\lambda = 4.00$
- (b)  $\lambda = 8$   $\lambda = 8.00$
- (c)  $4\lambda = 12$   $\lambda = 3.00$
- (d)  $5\lambda = 12$   $\lambda = 2.40$
- (e)  $6\lambda = 16$   $\lambda = 2.67$
- (f)  $8\lambda = 16$   $\lambda = 2.00$
- (g)  $4\lambda = 18$   $\lambda = 4.50$
- (h)  $6\lambda = 24$   $\lambda = 4.00$
- (j)  $8\lambda = 36$   $\lambda = 4.50$

The smallest  $\lambda$  is given by (f) and its combination with strong mechanisms for further reduction is necessary

See page 18 for  $M_p$ 's

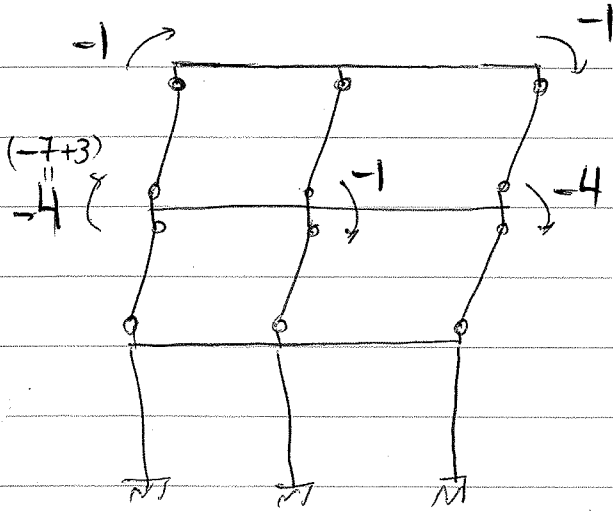

(k) = (g) + (h)

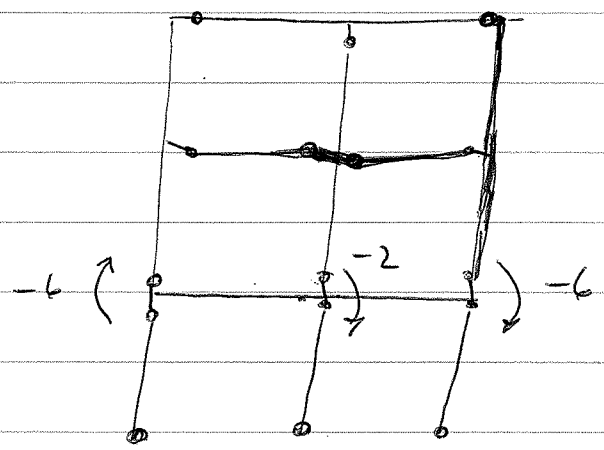

(l) = (k) + (j)

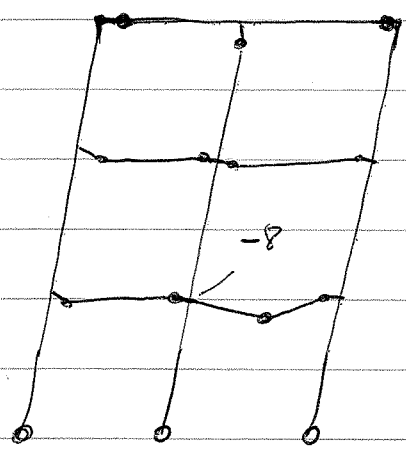

(m) = (l) + (f)

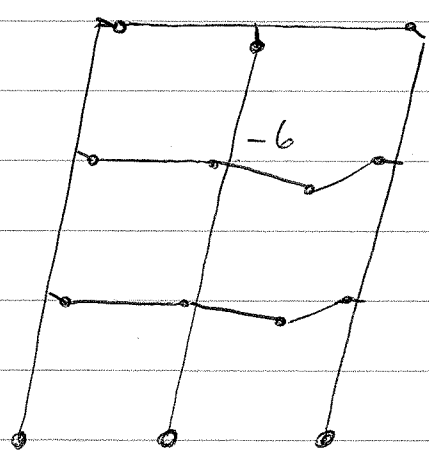

(n) = (m) + (d)

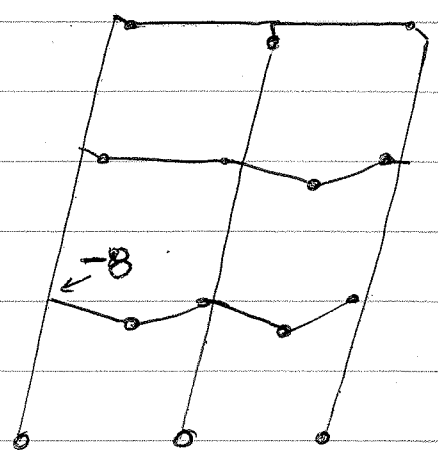

(o) = (n) + (e)

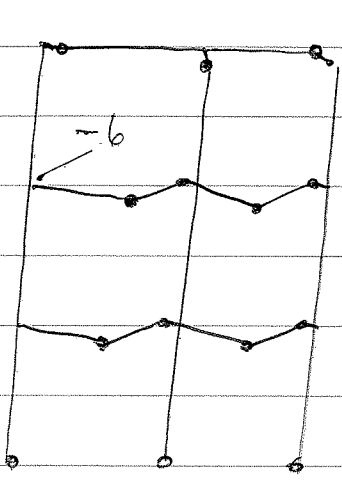

(d) = (a) + (c)

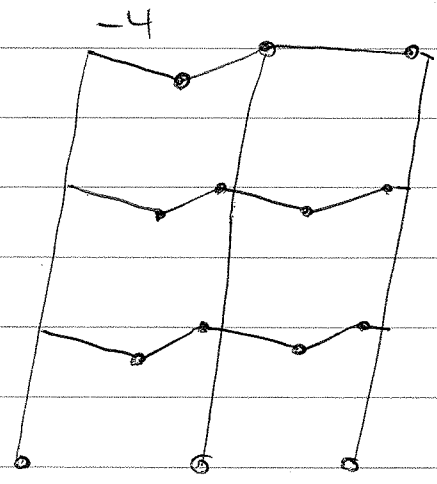

(g) = (d) + (a)

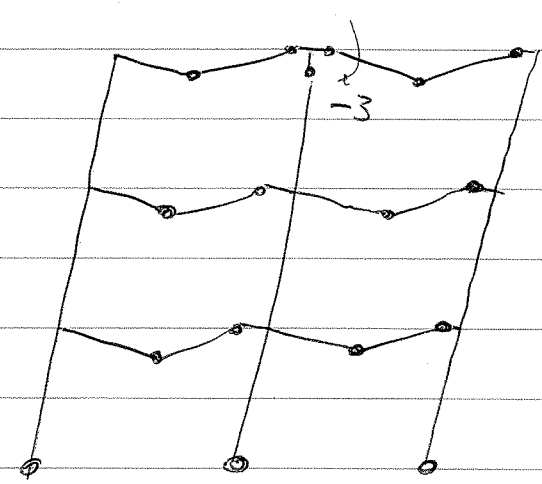

(f) = (g) + (b)

Now the calculations

(g)  $4\lambda = 18$

(h)  $6\lambda = 24$

$$\begin{array}{r} 10\lambda \quad 42 \\ \hline \quad \quad 11 \end{array}$$

rotate hinge

(k)  $10\lambda = 31 \quad \lambda = 3.10$

(j)  $8\lambda = 36$

$$\begin{array}{r} 18\lambda \quad 67 \\ \hline \quad \quad 14 \end{array}$$

rotate hinge

(l)  $18\lambda = 53 \quad \lambda = 2.94$

(i)  $8\lambda = 16$

$$\begin{array}{r} 26\lambda \quad 69 \\ \hline \quad \quad 8 \end{array}$$

cancel hinge

(m)  $26\lambda = 61 \quad \lambda = 2.35$

(d)  $5\lambda = 12$

$$\begin{array}{r} 31\lambda \quad 73 \\ \hline \quad \quad 6 \end{array}$$

cancel hinge

(n)  $31\lambda = 67 \quad \lambda = 2.16$

(e)  $6\lambda = 16$

$$\begin{array}{r} 37\lambda \quad 83 \\ \hline \quad \quad 8 \end{array}$$

cancel hinge

(o)  $37\lambda = 75 \quad \lambda = 2.03$

(c)	$4\lambda = 12$	
	$41\lambda \quad 87$	
cancel hinge	$6$	
(P)	$41\lambda = 81$	$\lambda = 1.976$
(a)	$2\lambda = 8$	

	$43\lambda \quad 89$	
cancel hinge	$4$	
(q)	$43\lambda = 85$	$\lambda = 1.977$
(b)	$\lambda = 8$	

	$44\lambda \quad 93$	
rotate hinge	$3$	
(r)	$44\lambda = 90$	$\lambda = 2.05$

Thus mechanism (P) is probably correct. The confirmation is left to the students to check for a statical analysis for yield condition.

NOTICE THAT  $R(S) = 18$  and in collapse only 14 hinges are formed in mechanism (P), so that five redundancies will be left at collapse.

ALLOWANCE FOR distributed load.

To allow the effect of distributed load the mechanism (P) is redrawn and hinges are considered away from the mid points of the beams.  $\lambda = 1.94$  is obtained in place of 1.98.

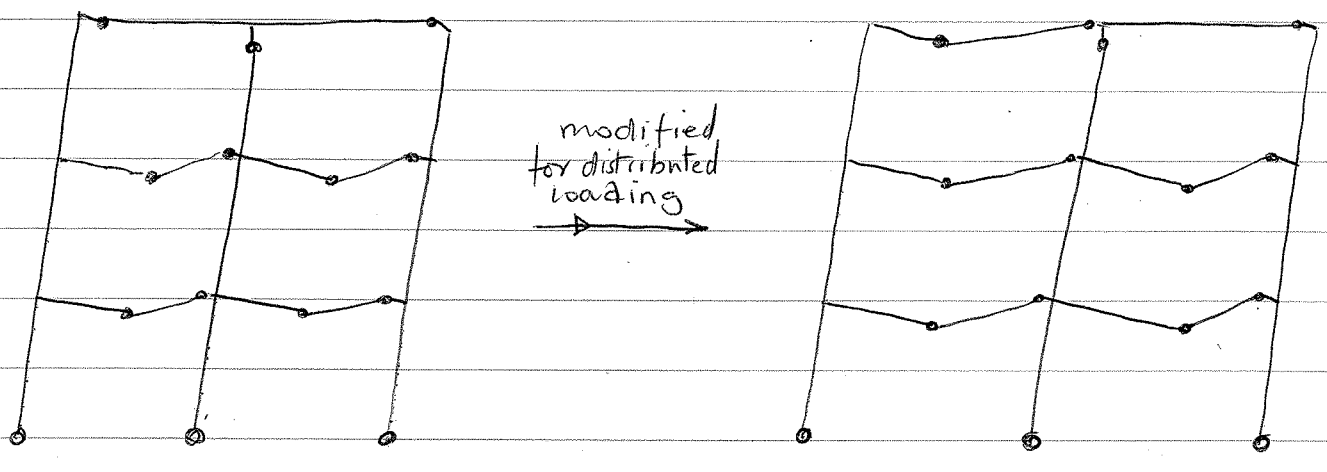

### 4.43 Distributed loads

In practice one does not need to calculate the effect of distributed load, and one critical section at the middle of the span is enough to be considered. To show this, an exact solution is considered and then critical section one used at quarter-points and the mid-point of the beam.

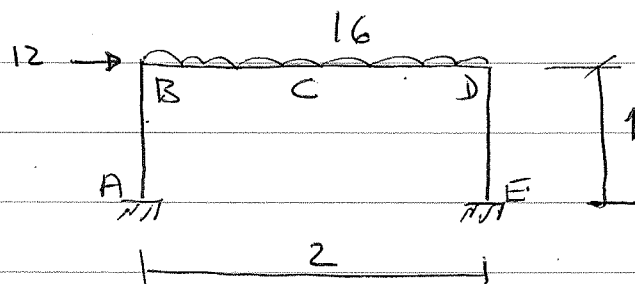

From pure side sway

$$4M_p = 12$$

i.e

$$M_p = 3.00$$

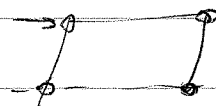

From beam mechanism



$$4M_p = 8$$

$$M_p = 2.00$$

The correct mechanism is as shown below

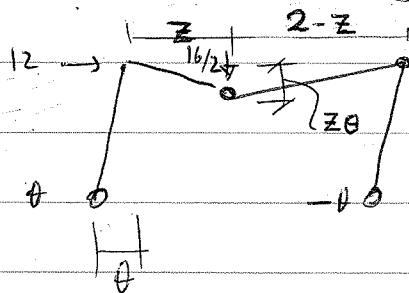

The collapse equation is given as

$$(12)(\theta) + (16)\left(\frac{1}{2}z\theta\right) = M_p \left[ 2 + 2\left(\frac{z}{2-z}\right) \right] \theta$$

or

$$M_p = \frac{2(6+z-2z^2)}{4-z}$$

Condition  $M_p$  to be max is

$$(1-4z)(1-z) + (6+z-2z^2) = 0$$

or

$$z = 4 - \sqrt{11} = 0.683$$

corresponding to

$$M_p = 30 - 8\sqrt{11} = 3.47$$

For an approximate solution, 7 critical sections are considered.

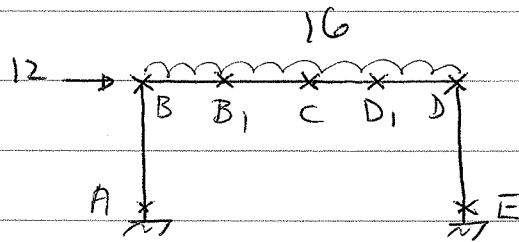

NOW make it statically determinate by hinges at B, D and E. and moments are calculated as

	A	B	B <sub>1</sub>	C	D <sub>1</sub>	D	E
Free Moment	12	0	-3	-4	-3	0	0

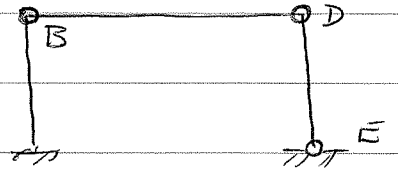

We have  $R=3$   $N=7$ , Thus  $N-R=7-3=4$  independent mechanisms should be considered.

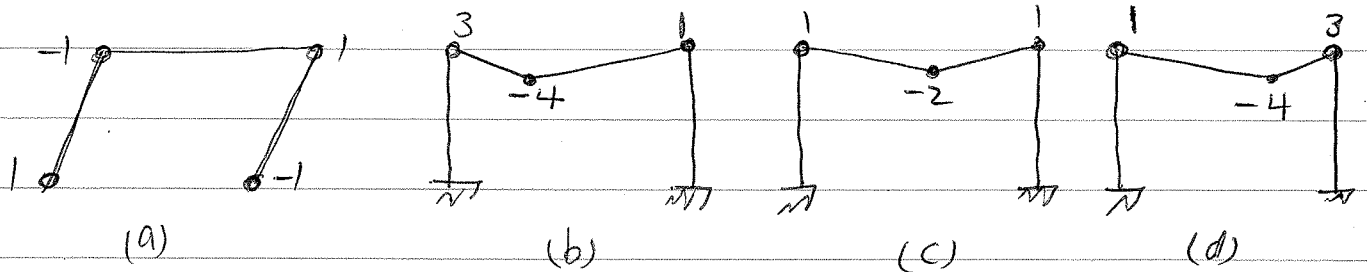

The collapse equation from (3.11) is written as

$$\sum (M_F) \phi = \sum M_p |\phi|$$

Taking  $M_F$  from the table, the collapse equations for above mechanisms are as:

$$(a) \quad 12 = 4M_p \quad M_p = 3.00$$

$$(b) \quad 12 = 8M_p \quad M_p = 1.50$$

$$(c) \quad 8 = 4M_p \quad M_p = 2.00$$

$$(d) \quad 12 = 8M_p \quad M_p = 1.50$$

Now the mechanisms should be combined to obtain a value of  $M_p$  greater than 3.00.

# Critical section at quarter-points (continued)

The only hinge which is common and can be cancelled is B, Thus each of three beam mechs. will be combined with sway mechanism as

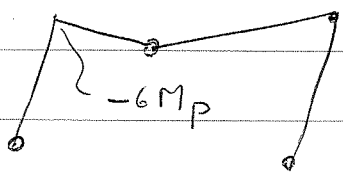

(e) = 3(a) + (b)

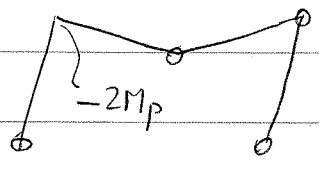

(f) = (a) + (c)

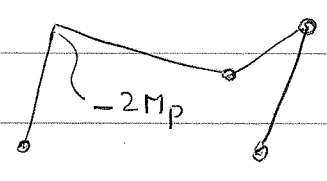

(g) = (a) + (d)

As can be seen the hinge rotation for mech (a) and (b) are not the same, and can not be cancelled by direct superposition, unless mech (a) is increased by 3 fold. This scaling must be reflected in writing the corresponding equations. NOTE the reduction 6Mp due to the cancellation of the hinge, since each hinge rotation at B is three units.

3(a)	36 = 12 Mp	
(b)	12 = 8 Mp	
	<hr/>	
	48	20 Mp
cancel hinge		6 Mp
(e)	<hr/>	<hr/>
	48 = 14 Mp	<b>Mp = 3.43</b>

(a)	12 = 4 Mp	
(c)	8 = 4 Mp	
	<hr/>	
	20	8 Mp
		2 Mp
(f)	<hr/>	<hr/>
	20 = 6 Mp	Mp = 3.33

(a)	12 = 4 Mp	
(d)	12 = 8 Mp	
	<hr/>	
	24	12 Mp
		2 Mp
(g)	<hr/>	<hr/>
	24 = 10 Mp	Mp = 2.40

Thus mech. (e) is the correct answer.  $M_p$  is only 1% more than exact  $M_p$

Had only a single critical section been taken, at the centre of the beam, then approx. solution would only be 4% different from the exact solution.

### 4.4.4 PITCHED - ROOF FRAMES

The same pitched roof as previous chapter will be analysed by combining mechanisms.

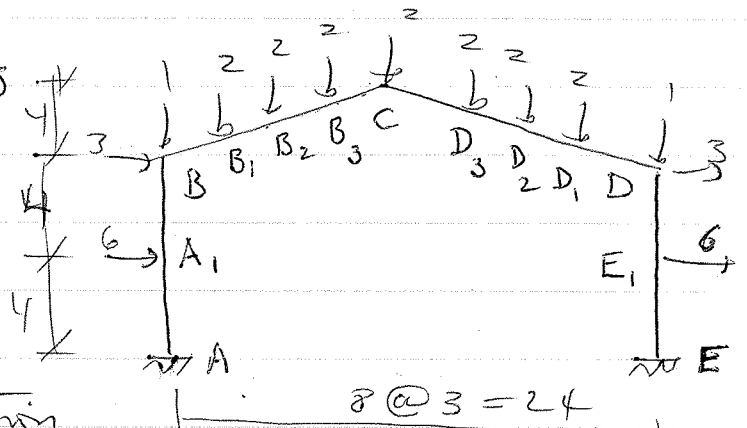

As a first approximation 5 critical sections A, B, C, D and E are considered.

The virtual work equation will again be used

$$\sum (M_F)_i \phi_i = \sum (M_p)_i |\phi_i|$$

cutting the pitch and finding Free B.M. as previous chapter

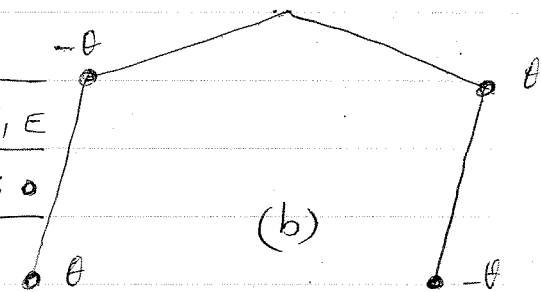
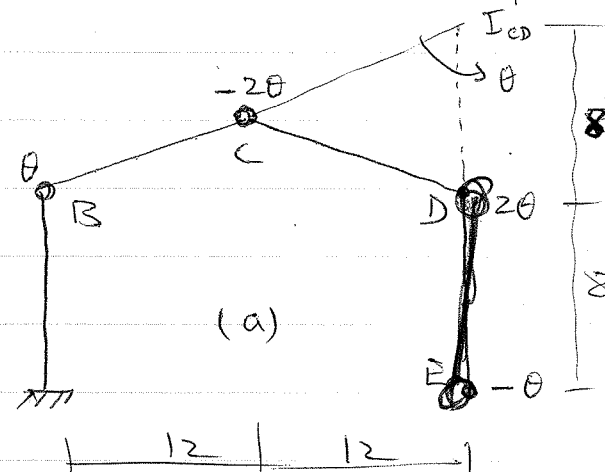

	A	A <sub>1</sub>	B	B <sub>1</sub>	B <sub>2</sub>	B <sub>3</sub>	C	D <sub>3</sub>	D <sub>2</sub>	D <sub>1</sub>	D	E, E
Free:	96	60	48	27	12	3	0	3	12	27	48	36

(a)  $144 = 6M_p \quad M_p = 24$   
 (b)  $96 = 4M_p \quad M_p = 24$

combining these as shown on the following page we have

(a)  $144 = 6M_p$

(b)  $96 = 4M_p$

---

240  $10M_p$

Cancel hinge B  $2M_p$

---

240  $= 8M_p$

$M_p = 30$

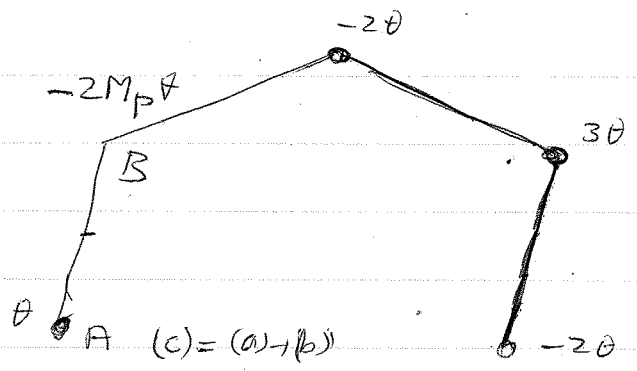

Thus so far from unsafe them  $M_p$  should at least be 30. This value is very close to true value 30.75 of previous chapters. The exact value can be found by allowing plastic hinges to form at actual critical sections at the sheeting rails (A, and E,) and the perlin points (B, etc.).



For each extra critical section one additional **basic mechanism** is needed. For example, for  $B_3$  the construction of extra basic independent mech. as shown may be considered.

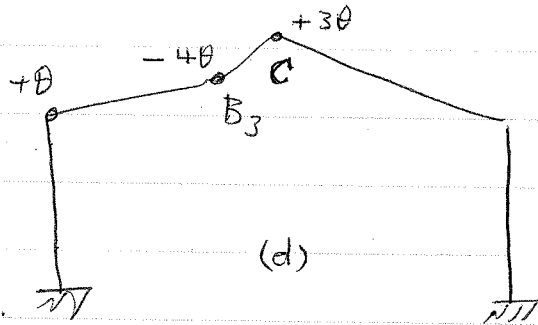

The collapse equation can be written as before using V. work and Free B.M.

Table.  $36 = 8M_p$  ;  $M_p = 4.5$

To combine (c) and (d) hinge rotation at C must first be made the same; that is the rotations of ~~(c)~~ (c) should be multiplied by a factor of 3, and those of (d) and above equation by a factor of 2, to cancel hinge at C.

$3 \times (c)$	$720 = 24M_p$
$2 \times (d)$	$72 = 16M_p$
	<hr style="width: 100%;"/>
	$792 = 40M_p$
cancel hinge C	$12M_p$
	<hr style="width: 100%;"/>
	$792 = 28M_p$ $M_p = 28.3$

The mechanism as shown has 5 hinges, and cannot be at state of equilibrium. However hinge B can be closed up by using again sway mech.

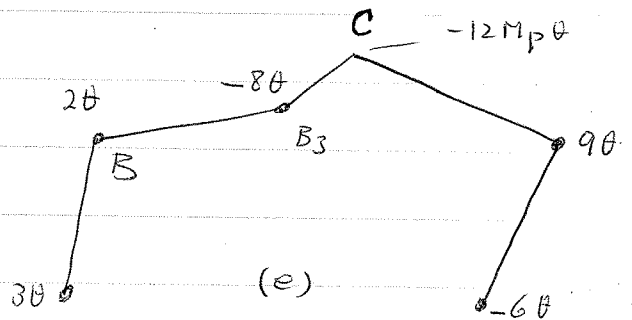

<del>(c)</del>	$792 = 28M_p$
$2(\text{sway})$	$192 = 8M_p$
	<hr style="width: 100%;"/>
	$984 = 36M_p$
cancel B	$4M_p$
	<hr style="width: 100%;"/>
	$984 = 32M_p$ $M_p = 30.75$

This is now with 4 hinges and leads to exact answer  $M_p = 30.75$ . This method is very bad for this type of structures.