

8

OPTIMAL PLASTIC DESIGN OF FRAMES; LINEAR PROGRAMMING AND MATRIX FORMULATION

8.1 Introduction

The various ways in which engineers fix the geometry and details of structures may be collectively considered under the heading of design. Only part of the design process is generally considered to be quantifiable and when the quantifiable elements are associated with some functional measure of the design objective, then the mathematical methods of optimization may be utilized to arrive at an optimal design in an automated fashion. Such a process is termed synthesis and when an optimal design is sought such that the structure will not collapse plastically for a limit load factor inferior to some specified value, then it is termed plastic limit synthesis.

Normally, plastic limit synthesis will only be used to obtain a rational first approx. to the final design. The various design considerations which are not readily quantified, or have been deliberately omitted to simplify the computation, may cause modifications to be imposed before finalizing the design.

In this chapter plastic limit synthesis using mathematical programming approach is described. A formulation of mesh and node methods for frames of specified topology and geometry is presented. Only simplex method (linear case) is described as a mathematical programming approach.

8.2 MESH and nodal descriptions

8.2.1 Mesh description of statics

consider a portal frame as shown in Fig 8.1a with critical sections specified as Fig. 8.1b.

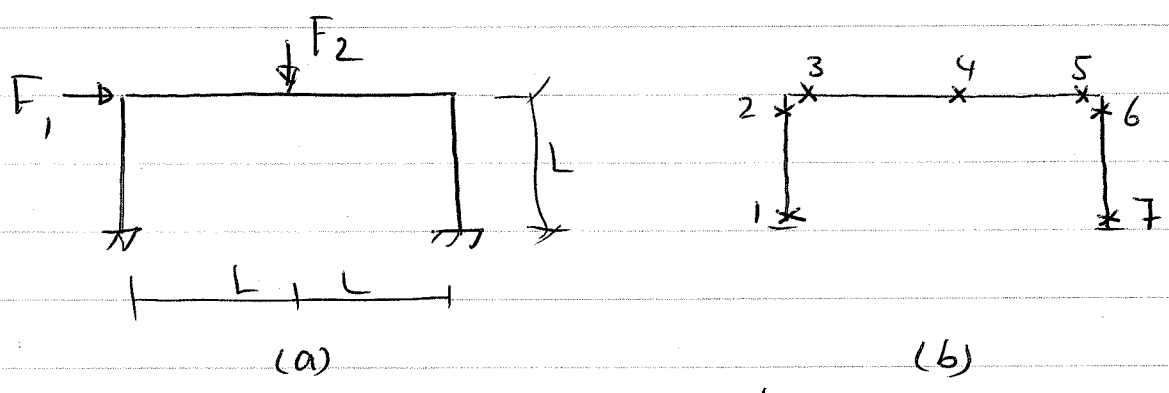
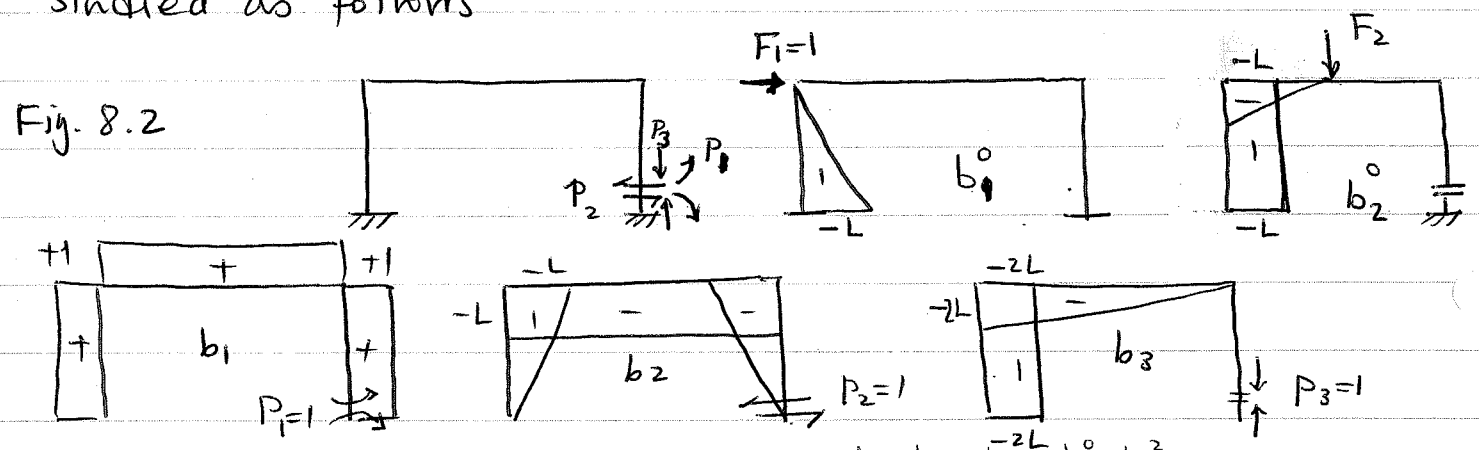

Fig. 8.1. A portal frame.

This frame which has $\gamma(S) = 3$, may be reduced to a determinate one in different ways. Two such cases are studied as follows



The bending moment at 7 sections can be specified in terms of P_1, P_2, P_3 and F_1, F_2 as
 written more compactly as

$$[M] = [B \mid B_0] \begin{bmatrix} P \\ F \end{bmatrix}$$

$$\begin{bmatrix} M_1 \\ M_2 \\ M_3 \\ M_4 \\ M_5 \\ M_6 \\ M_7 \end{bmatrix} = \begin{bmatrix} +1 & \cdot & -2L & -L & -L \\ +1 & -L & -2L & \cdot & -L \\ +1 & -L & -2L & \cdot & -L \\ +1 & -L & -L & \cdot & \cdot \\ +1 & -L & \cdot & \cdot & \cdot \\ +1 & -L & \cdot & \cdot & \cdot \\ +1 & \cdot & \cdot & \cdot & \cdot \end{bmatrix} \begin{bmatrix} P_1 \\ P_2 \\ P_3 \\ F_1 \\ F_2 \end{bmatrix}$$

Using a different redundants as moments at 3 sections, as shown in Fig. 8.3 The following B and B₀ matrices are obtained for renumbered sections as Fig. 8.4.

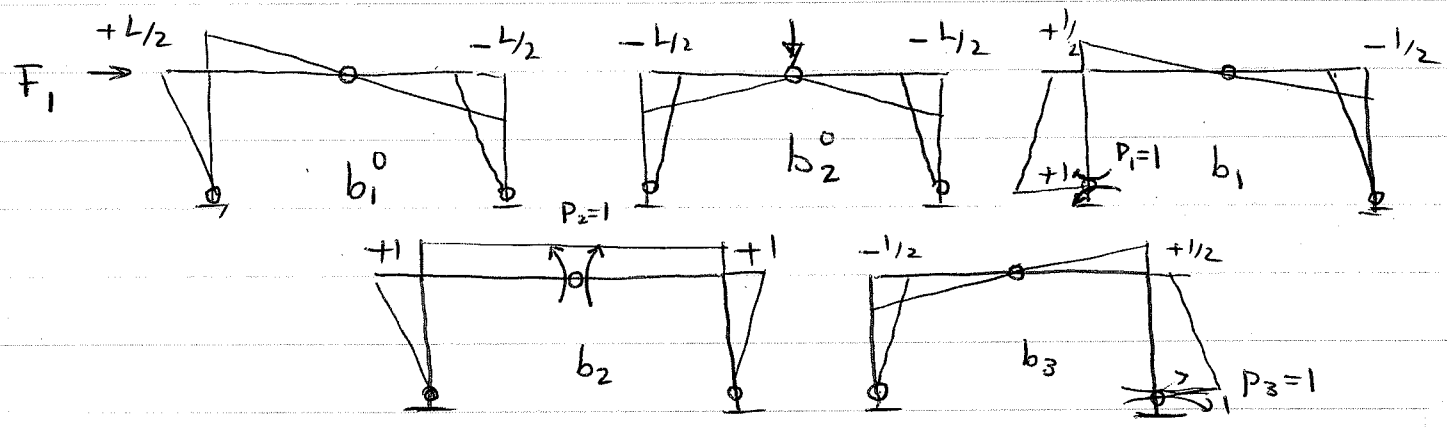

Fig. 8.3 B.M. Diagrams for unit values of loads and bi-actions (a canonical basis)

$$B = \begin{bmatrix} +1 & \cdot & \cdot \\ \cdot & +1 & \cdot \\ \cdot & \cdot & +1 \\ \hline +1/2 & +1 & -1/2 \\ +1/2 & +1 & -1/2 \\ -1/2 & +1 & +1/2 \\ -1/2 & +1 & +1/2 \end{bmatrix}$$

$$B_0 = \begin{bmatrix} \cdot & \cdot \\ \cdot & \cdot \\ \cdot & \cdot \\ \hline +1/2 & -1/2 \\ +1/2 & -1/2 \\ -1/2 & -1/2 \\ -1/2 & -1/2 \end{bmatrix}$$

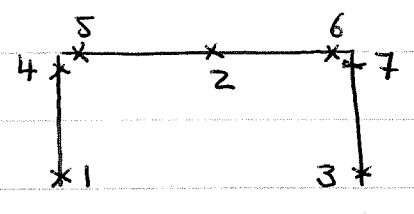

Fig. 8.4 Renumbered critical sections

Because of the special algebraic structure associated with this release system it is termed a canonical basis of the frame.

Selection of a canonical basis is not so easy specially when frame becomes complex (This is not true when my cycle selection algorithm is used). For frame shown in Fig. 8.5 various cycle bases are shown in Fig. 8.6 and 8.7.

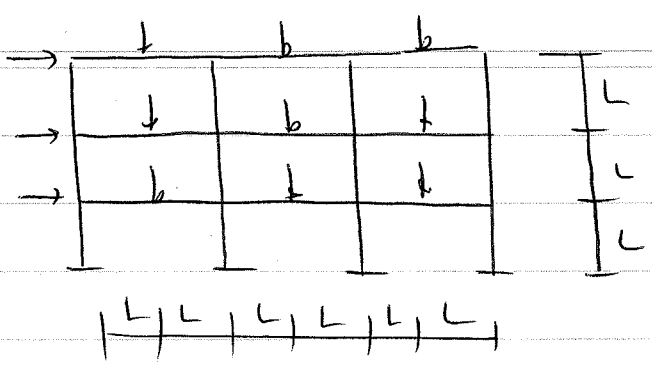
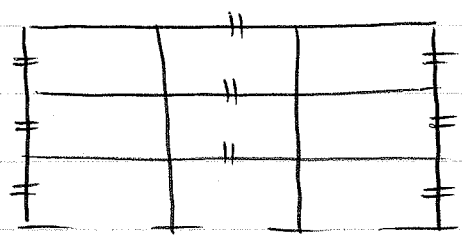
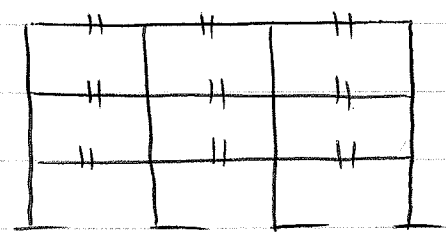

Fig. 8.5 A multi storey frame



(a)



(b)

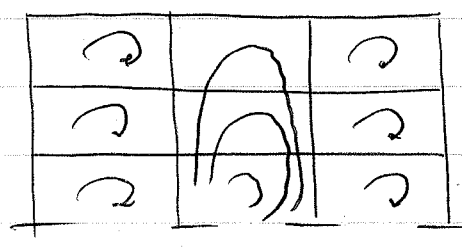

(a)

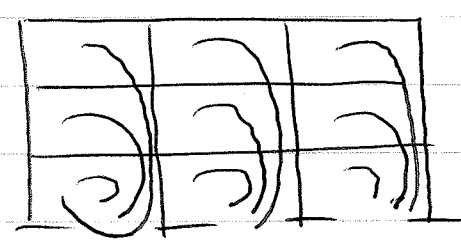

(b)

Fig. 8.6 Two ent systems and corresponding fundamental cycle bases

A much better cycle basis is a mesh basis as shown in Fig. 8.7.

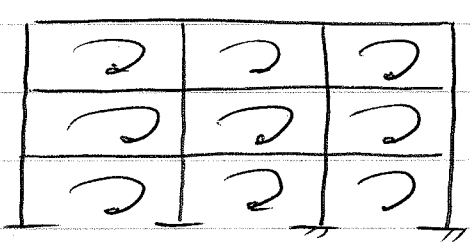

Fig. 8.7 A mesh basis

The following diagrams (b_1, b_2, b_3) of Fig. 8.8 are applied to each regional cycle of Fig. 8.7 and matrix B is obtained.

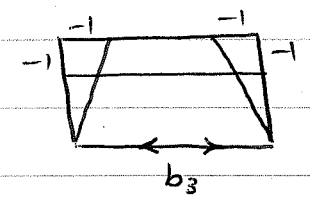
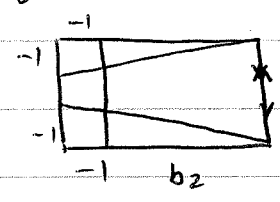
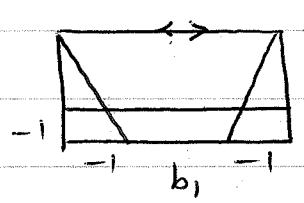
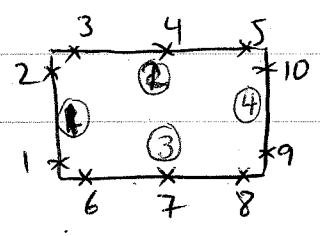

Fig. 8.8 unit diagrams for a regional cycle.

submatrices corresponding to each typical cycle are as follows:

for a typical cycle

$$[B] = \begin{matrix} \text{①} \\ \text{②} \\ \text{③} \\ \text{④} \end{matrix} \begin{matrix} 1 \\ 2 \\ 3 \\ 4 \\ 5 \\ 6 \\ 7 \\ 8 \\ 9 \\ 10 \end{matrix} \begin{matrix} B_1 \\ B_2 \\ B_3 \\ B_4 \end{matrix}$$

$$B_1 = \begin{matrix} b_1 & b_2 & b_3 \\ 1 & -1 & \cdot \\ 2 & \cdot & -1 & -1 \end{matrix}$$

$$B_2 = \begin{matrix} b_1 & b_2 & b_3 \\ 3 & \cdot & -1 & -1 \\ 4 & \cdot & -1/2 & -1 \\ 5 & \cdot & \cdot & -1 \end{matrix}$$

$$B_3 = \begin{matrix} 6 & +1 & +1 & \cdot \\ 7 & +1 & +1/2 & \cdot \\ 8 & +1 & \cdot & \cdot \end{matrix}$$

$$B_4 = \begin{matrix} 9 & +1 & \cdot & \cdot \\ 10 & \cdot & \cdot & +1 \end{matrix}$$

The sign convention used is shown in Fig. (8.9)

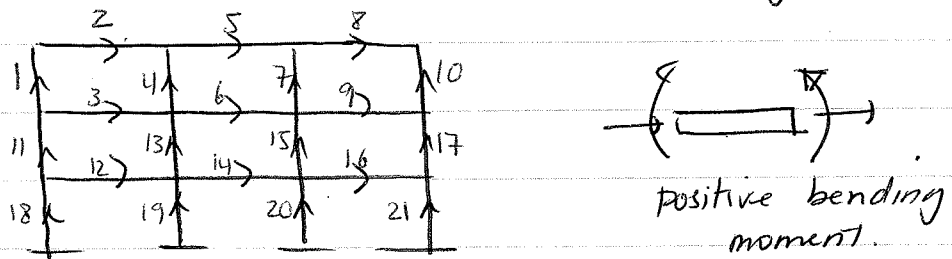

Fig. 8.9 member orientations and edge numbers

It should be noted that the elements of B matrix are independent of the dimensions of the rectangular meshes, provided that the critical sections are maintained in the same relative positions.

B =

edge	cycle	1	2	3	4	5	6	7	8	9
1	B ₁
2	B ₂
3	B ₃	.	.	.	B ₂
4	B ₄	B ₁
5	B ₂
6	B ₃	6
7	B ₄	B ₁
8	B ₂
9	B ₃
10	B ₄
11	B ₁
12	B ₃	.	.	.	B ₃	.	.	B ₂	.	.
13	B ₄	.	.	.	B ₄	B ₁	.	.	B ₂	.
14	B ₂	B ₃	B ₁	.	B ₂	.
15	B ₃	B ₄	B ₁	.	.	.
16	B ₄	B ₃	.	B ₂	.
17	B ₂	B ₄	.	.	.
18	B ₁	B ₁	.	.
19	B ₃	B ₄	B ₁	.
20	B ₄	B ₄	B ₁
21	B ₂	B ₄

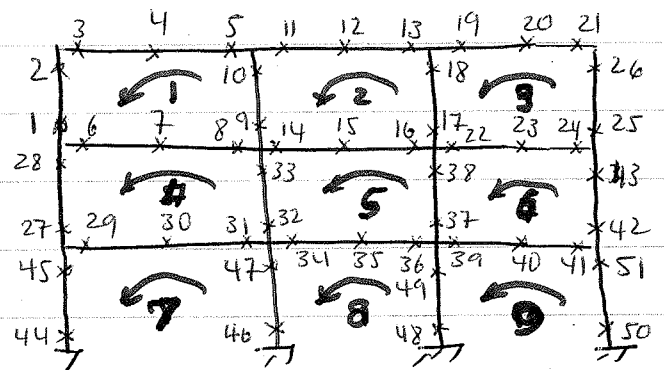

Fig. 8.10 critical sections numbering

B₀ can be obtained from any set of B.M.s which are in equilibrium with unit loads.

8.2.2 Mesh description of kinematics

If a mechanism is created by allowing flexural deformations at critical section 1 with the primary structure of Fig. 8.11,

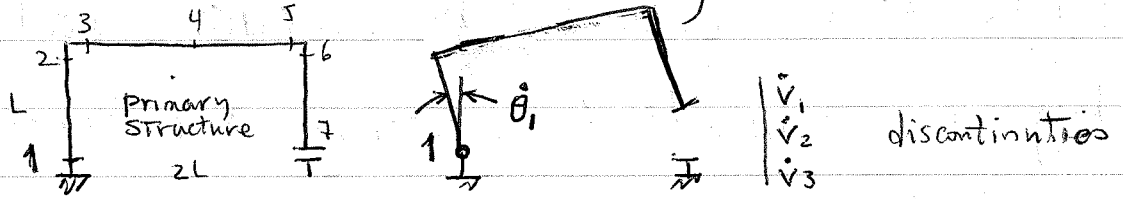

Fig. 8.11 Kinematics of primary structure.

then the rate of angular discontinuity (\dot{v}_1), horizontal discontinuity (\dot{v}_2), and vertical discontinuity (\dot{v}_3) can all be determined in terms of the deformation rate $\dot{\theta}_1$ from the undeformed geometry of the frame [see page 2 O.K.]

$$\dot{v}_1 = (+1)\dot{\theta}_1 \quad \dot{v}_2 = (0)\dot{\theta}_1 \quad \dot{v}_3 = (-2L)\dot{\theta}_1$$

or in terms of the coefficients of static matrix $[B]$

$$\dot{v}_1 = b_{11}\dot{\theta}_1 \quad \dot{v}_2 = b_{12}\dot{\theta}_1 \quad \dot{v}_3 = b_{13}\dot{\theta}_1$$

similarly, flexural deformations can be introduced into the same primary structure at each of remaining critical sections and their total effects on the discontinuities at the cut can be obtained by superposition.

$$\begin{bmatrix} \dot{v}_1 \\ \dot{v}_2 \\ \dot{v}_3 \end{bmatrix} = \begin{bmatrix} b_{11} & b_{21} & \dots & b_{71} \\ b_{12} & b_{22} & & b_{72} \\ b_{13} & b_{23} & & b_{73} \end{bmatrix} \begin{bmatrix} \dot{\theta}_1 \\ \dot{\theta}_2 \\ \dot{\theta}_3 \\ \vdots \\ \dot{\theta}_7 \end{bmatrix}$$

and more compactly

$$\dot{v} = B^t \dot{\theta}$$

In a similar way the rates of displacements $\{u_1, u_2\}$ which correspond to vectorially to the loads $\{F_1, F_2\}$ can be evaluated in terms of the deformation rates

$$\begin{bmatrix} \dot{u}_1 \\ \dot{u}_2 \end{bmatrix} = \begin{bmatrix} b_{11}^0 & b_{21}^0 & \dots & b_{71}^0 \\ b_{12}^0 & b_{22}^0 & & b_{72}^0 \end{bmatrix} \begin{bmatrix} \dot{\theta}_1 \\ \dot{\theta}_2 \\ \vdots \\ \dot{\theta}_7 \end{bmatrix}$$

or

$$\dot{u} = B_0^t \dot{\theta}$$

Thus the kinematic relations for the mesh description may be summarized as

$$\begin{bmatrix} \dot{v} \\ \dot{u} \end{bmatrix} = \begin{bmatrix} B^t \\ B_0^t \end{bmatrix} \begin{bmatrix} \dot{\theta} \end{bmatrix}$$

However, the cut (and its associated discontinuity) is merely a convenient concept and for compatibility $\dot{v} = 0$

Hence

$$B^t \dot{\theta} = 0$$

The above argument can be generalised to all physical release systems and multi-mesh graphs.

8.2.3 Static - kinematic duality.

The static and kinematic transformations for the considered class of problems can be summarised as follows:

Statics	$M_p = Bp$	$M_F = B_0 F$
Kinematics	$\dot{v} = B^t \dot{\theta}$	$\dot{u} = B_0^t \dot{\theta}$

where M_p and M_F are the bending moments associated with the mesh forces (Redundants) and the loads, respectively. The above contragradient relationships can be represented in the duality diagram of Fig. 8.12.

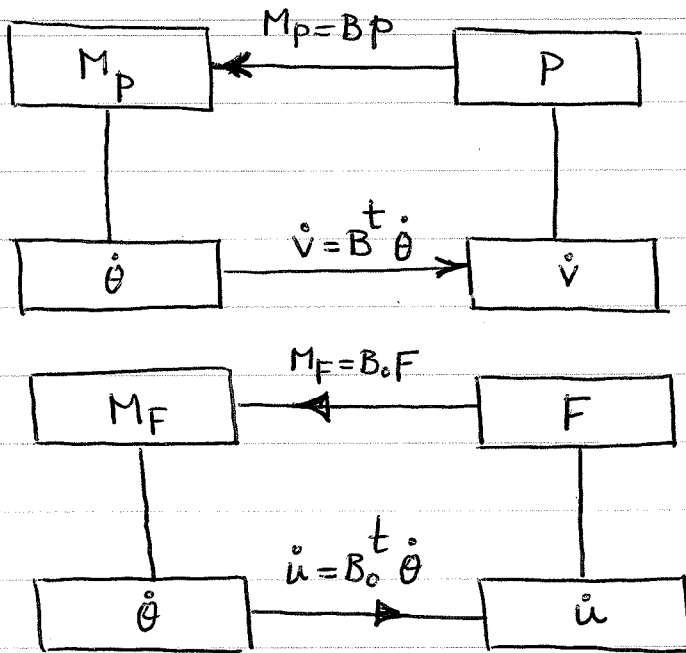
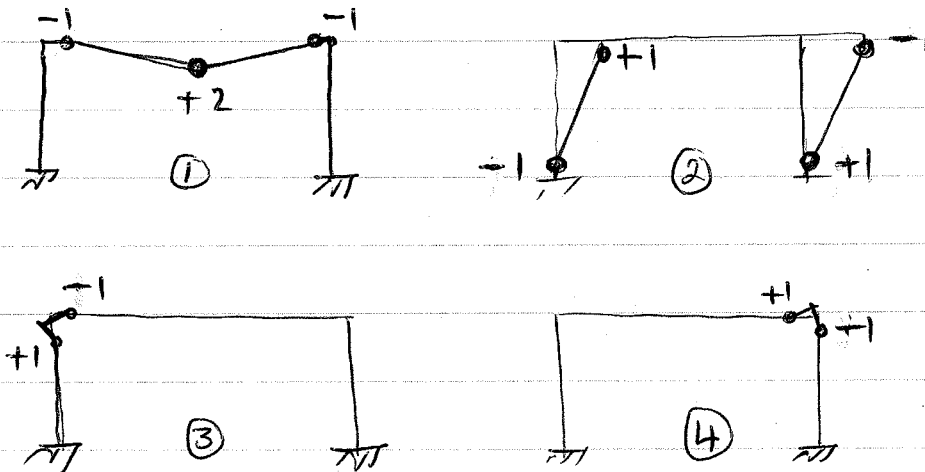

Fig. 8.12 static-kinematic duality (SKD) for mesh description

8.2.4 Nodal description of kinematics

The nodal description may be considered to have its origins in the concept of mechanisms and it is natural to commence its discussion with consideration of bases of the mechanism space. There are the collections of all the beam, sway and joint mechs. for rectangular frames, Fig. 8.12.



NOTICE THE SIGN CONVERSION reverse of ours

Fig. 8.12 elementary mechanisms

If the elementary mechanisms are associated with parameters x_1, x_2, x_3 and x_4 , which will play the role of nodal displacements (or generalised displacements in the Lagrange sense), then any set of compatible deformation rates can be written as

$$\begin{bmatrix} \dot{\theta}_1 \\ \dot{\theta}_2 \\ \dot{\theta}_3 \\ \dot{\theta}_4 \\ \dot{\theta}_5 \\ \dot{\theta}_6 \\ \dot{\theta}_7 \end{bmatrix} = \begin{bmatrix} \cdot & -1 & \cdot & \cdot \\ \cdot & +1 & +1 & \cdot \\ -1 & \cdot & -1 & \cdot \\ +2 & \cdot & \cdot & \cdot \\ -1 & \cdot & \cdot & +1 \\ \cdot & -1 & \cdot & -1 \\ \cdot & +1 & \cdot & \cdot \end{bmatrix} \begin{bmatrix} \dot{x}_1 \\ \dot{x}_2 \\ \dot{x}_3 \\ \dot{x}_4 \end{bmatrix}$$

Similar equations as above can be written for any number of critical sections and any number of independent mechanisms in the basis

$$\dot{\theta} = C \dot{x}$$

Similarly the displacement rates (\dot{u}) can be expressed in terms of nodal velocities (\dot{x})

$$\begin{bmatrix} \dot{u}_1 \\ \dot{u}_2 \end{bmatrix} = \begin{bmatrix} \cdot & L & \cdot & \cdot \\ L & \cdot & \cdot & \cdot \end{bmatrix} \begin{bmatrix} \dot{x}_1 \\ \dot{x}_2 \\ \dot{x}_3 \\ \dot{x}_4 \end{bmatrix}$$

Hence for all such systems

$$\dot{u} = C_0 \dot{x}$$

An alternative basis can be constructed from the canonical basis of the mesh description of statics discussed for SKD. One such selection of "basic mechanisms" is shown in Fig. 8.13 where

previous numbering is now used.

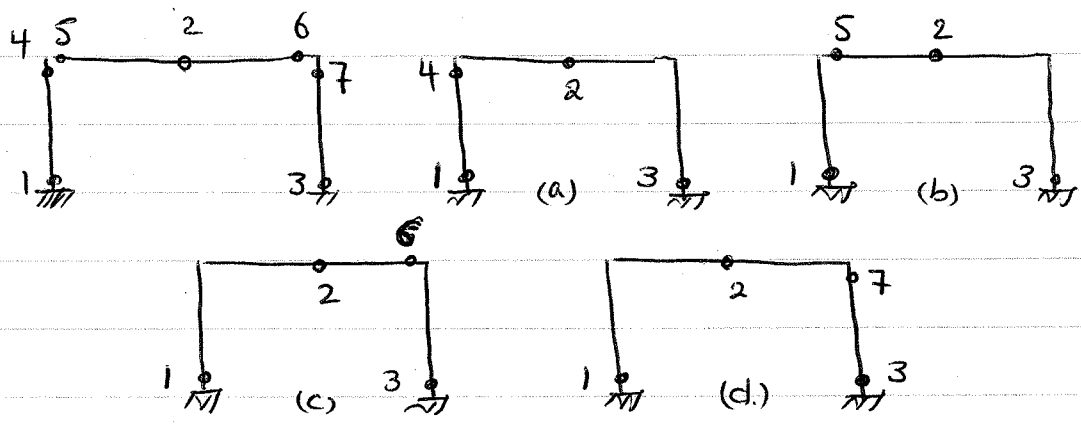

Fig. 8.13 Numbering and four basic mechanisms.

one feature of such a basic mechanisms is that their nodal deformations can be immediately listed from the elements of the corresponding B matrix. In a similar way, the dispts of the mechanisms can be obtained from the elements of the B₀ matrix. Thus, a canonical basis of the mesh statics generates a form of canonical basis for the nodal kinematics.

$$\begin{bmatrix} \dot{\theta}_1 \\ \dot{\theta}_2 \\ \dot{\theta}_3 \\ \dot{\theta}_4 \\ \dot{\theta}_5 \\ \dot{\theta}_6 \\ \dot{\theta}_7 \end{bmatrix} = \begin{bmatrix} -b_{41} & -b_{51} & -b_{61} & -b_{71} \\ -b_{42} & -b_{52} & -b_{62} & -b_{72} \\ -b_{43} & -b_{53} & -b_{63} & -b_{73} \\ 1 & . & . & . \\ . & 1 & . & . \\ . & . & 1 & . \\ . & . & . & 1 \end{bmatrix} \begin{bmatrix} \dot{x}_1 \\ \dot{x}_2 \\ \dot{x}_3 \\ \dot{x}_4 \end{bmatrix}$$

or

$$\dot{\theta} = C \dot{x}$$

Similarly

$$\begin{bmatrix} \dot{u}_1 \\ \dot{u}_2 \end{bmatrix} = \begin{bmatrix} -b_{41}^0 & -b_{51}^0 & -b_{61}^0 & -b_{71}^0 \\ -b_{42}^0 & -b_{52}^0 & -b_{62}^0 & -b_{72}^0 \end{bmatrix} \begin{bmatrix} \dot{x}_1 \\ \dot{x}_2 \\ \dot{x}_3 \\ \dot{x}_4 \end{bmatrix}$$

or

$$\dot{u} = C_0 \dot{x}$$

Thus the nodal kinematic relations are

$$\begin{bmatrix} \dot{u} \\ \dot{\theta} \end{bmatrix} = \begin{bmatrix} c_0 \\ c \end{bmatrix} \begin{bmatrix} \dot{x} \end{bmatrix}$$

8.2.5 Nodal description of statics

It is now to introduce static quantities which are the duals of the nodal displacements. These new entities (y) will be termed 'nodal forces'. It will be seen that, to maintain consistently SKD, the new quantities must be defined as

$$y = C_0 F$$

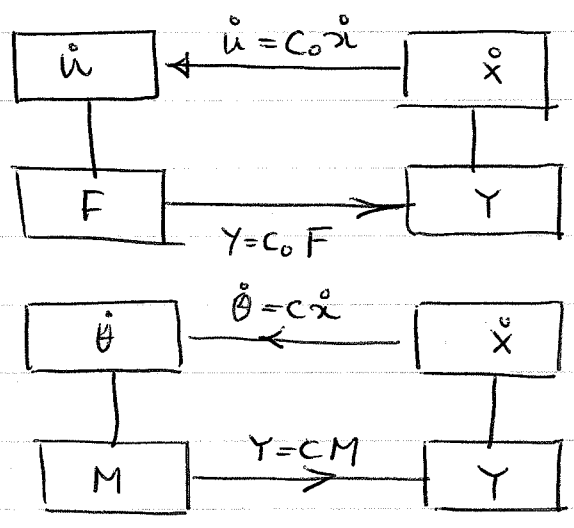

Fig. 8.14 Static-kinematic duality for nodal description

From second diagram, to maintain a set of moments (M) in equilibrium, it is necessary to relate them to the nodal forces (Y) as

$$CM = Y$$

Thus

$$\begin{bmatrix} c_0 & c \end{bmatrix} \begin{bmatrix} -F \\ M \end{bmatrix} = 0$$

and the dual relations for the nodal description can now be

Summarized as

$$\text{Kinematics} \quad \begin{bmatrix} \dot{u} \\ \dot{\theta} \end{bmatrix} = \begin{bmatrix} c_0 \\ c \end{bmatrix} \begin{bmatrix} \dot{x} \\ \dot{\alpha} \end{bmatrix}$$

$$\text{Statics} \quad [c_0 \mid c] \begin{bmatrix} -F \\ M \end{bmatrix} = 0$$

8.3 Plastic limit synthesis

8.3.1 design objective

Rectangular frame are considered with fixed topology and geometry, whose members are straight and prismatic with perfectly plastic material. An optimal design will be attained when the plastic moments of resistance are evaluated such that some objective function is optimized subject to satisfying the design constraints.

It should be remembered that any such synthesis is at best a first approximation to the final design and that there is considerable advantage attached to using a simplified model for a preliminary synthesis before (if necessary) undertaking a subsequent, more realistic (but presumably more complex) synthesis.

As an illustrative example consider frame of Fig. 8.15 with design variables as shown in Fig. 8.16 and critical section as Fig. 8.17.

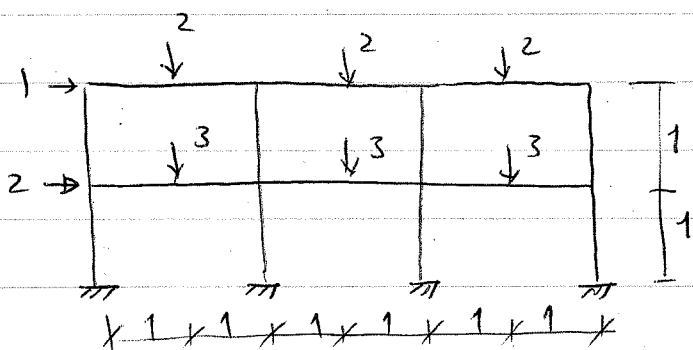

Fig. 8.15

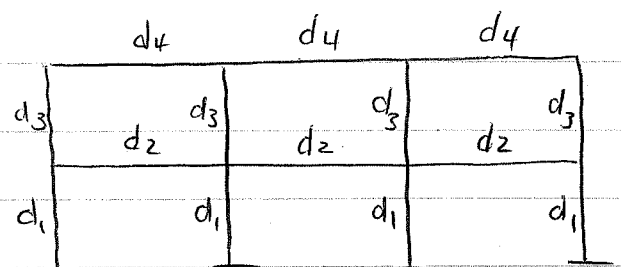

Fig. 8.16 design variables

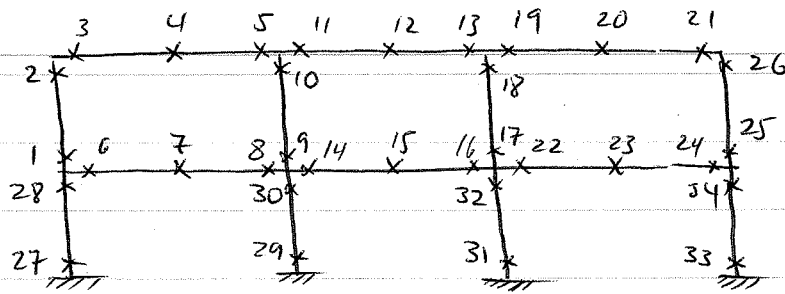

Fig. 8.17 Critical sections and their numbering

Design variables consist of the plastic moment of resistance of the elements for members $\{d_1, d_2, d_3, d_4\}$. An evaluation of the vector d which satisfies all the constraints will represent a feasible solution. However if optimality is sought, it is first necessary to measure the value or worth of any feasible design.

In this study objective function is considered as

$$Z = l_1 d_1 + l_2 d_2 + l_3 d_3 + l_4 d_4$$

where l_i is the length of all member made of cross section with M_p equal to d_i . For our example $l_1 = l_3 = 4$ and $l_2 = l_4 = 6$.

Therefore we want to minimize Z subject to constraints. This linearization is desirable in order to make use of the available math. prog. method; i.e. simplex method.

8.3.2 Mesh safe LP

The equilibrium equations have previously been obtained as

$$M = BP + B_0 F$$

where the limit loads are specified through a single parameter

$$(s) \quad B_0 F = b_0 \lambda$$

Also, since this limit load multiplier λ is known

$$B_0 F = \lambda_0 S_0 = b$$

The equilibrium equation become

$$M = BP + b$$

where b is the list of particular solution bending moments at the critical sections.

The yield conditions for critical section 1 of Fig. 8.15 becomes

$$-d_3 \leq M_1 \leq +d_3$$

however

$$M_1 = \sum_{i=1}^r b_{1i} p_i + b_1$$

d_3
↓
 $r = 3 \times 9 = 27$

Therefore

$$d_3 - \sum_{i=1}^r b_{1i} p_i \geq b_1$$

$$d_3 + \sum_{i=1}^r b_{1i} p_i \geq -b_1$$

Assembling all such conditions of static admissibility for all the critical sections, the following set of inequalities are obtained

$$\begin{bmatrix} J_s & -B \\ J_s & B \end{bmatrix} \begin{bmatrix} d \\ p \end{bmatrix} \geq \begin{bmatrix} b \\ -b \end{bmatrix}$$

where J_s is an incidence matrix which relates the design variables of this steel frame to the critical sections and b is the list of particular solution bending moments at the critical sections. The matrices J_s and b , where b is obtained from Fig. 8.18 is given as shown

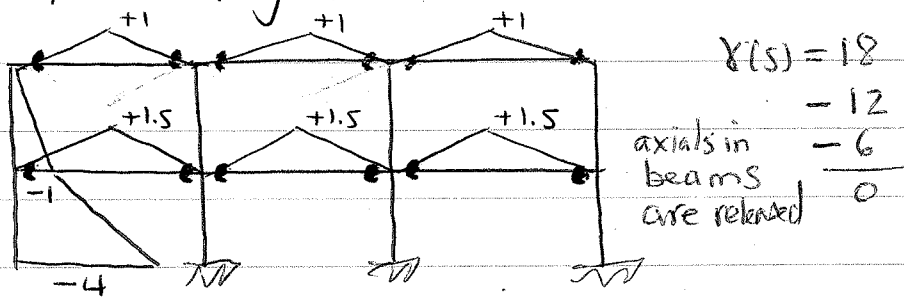

Fig. 8.18 particular solution B.Ms.

in the next page.

	d_i	1	2	3	4
Cross Sections					
J_s	1	.	.		.
	2	.	.		.
	3	.	.		.
	4	.	.		.
	5	.	.		.
	6	.	.		.
	7	.	.		.
	8	.	.		.
	9	.	.		.
	10	.	.		.
	11	.	.		.
	12	.	.		.
	13	.	.		.
	14	.	.		.
	15	.	.		.
	16	.	.		.
	17	.	.		.
	18	.	.		.
	19	.	.		.
	20	.	.		.
	21	.	.		.
	22	.	.		.
	23	.	.		.
	24	.	.		.
	25	.	.		.
	26	.	.		.
	27		.	.	.
	28		.	.	.
	29		.	.	.
	30		.	.	.
	31		.	.	.
	32		.	.	.
	33		.	.	.
	34		.	.	.

$$b = \begin{bmatrix} -1 \\ \vdots \\ +1 \\ \vdots \\ +1.5 \\ \vdots \\ +1 \\ \vdots \\ +1.5 \\ \vdots \\ +1 \\ \vdots \\ +1.5 \\ \vdots \\ -4 \\ -1 \\ \vdots \\ \vdots \\ \vdots \\ \vdots \end{bmatrix}$$

The matrix B is assembled from the generalized mesh description as discussed in section 8.2.1 (page 5)

Defining

$$J \equiv \begin{bmatrix} J_s \\ J_s \end{bmatrix} \text{ and } N \equiv [I \mid -I]$$

The static admissibility condition becomes

$$\begin{bmatrix} J & | & -N^t B \end{bmatrix} \begin{bmatrix} d \\ p \end{bmatrix} \geq N^t b$$

where the design variables d are non-negative, but the mesh forces (redundants) are unrestricted in sense.

From the safe Theorem of plastic limit analysis, any static solution (d and P) which satisfies static admissibility corresponds to a safe design. Thus the mesh safe LP of plastic limit synthesis is

$$\text{subject to } \begin{aligned} \text{Min } z &= [l^t \ 1 \ 0] \begin{bmatrix} d \\ P \end{bmatrix} \\ [J \ 1 \ -N^t B] \begin{bmatrix} d \\ P \end{bmatrix} &\geq N^t b \\ d &\geq 0 \end{aligned}$$

8.3.3 Nodal safe LP

A somewhat similar argument to that of the previous section can now be based on the nodal description of statics. The fundamental static relation developed in sect. 8.25 was

$$c^t M = c_0^t F$$

since the limit loads are completely specified

$$c_0^t F = a$$

where a is a known vector. Therefore from above and

$$\begin{bmatrix} c_0^t & | & c^t \end{bmatrix} \begin{bmatrix} -F \\ M \end{bmatrix} = 0$$

we obtain

$$c^t M = a \quad *$$

From plasticity relations and technological constraints

$$N^t M \leq Jd$$

or

$$Jd - N^t M \geq 0 \quad **$$

Therefore the constraints $*$, $**$ becomes

$$\begin{bmatrix} J & | & -N^t \\ 0 & | & c^t \end{bmatrix} \begin{bmatrix} d \\ M \end{bmatrix} \geq \begin{bmatrix} 0 \\ a \end{bmatrix}$$

Now the problem is to minimize $z = l^t d$. Therefore

$$\text{Min } z = [c^t \mid 0] \begin{bmatrix} d \\ M \end{bmatrix}$$

subject to

$$\left[\begin{array}{c|c} J & -N^t \\ \hline 0 & c^t \end{array} \right] \begin{bmatrix} d \\ M \end{bmatrix} \geq \begin{bmatrix} 0 \\ a \end{bmatrix}$$

$$d \geq 0$$

The necessary conditions of optimality of a mathematical programming are termed Kuhn-Tucker conditions, and in the case of LP they are sufficient. It can be proved (see e.g. Munro) that these conditions are satisfied for our formulations.