

Balanced Scorecard with Fuzzy Inference as a Performance Measurement in an Automotive Manufacturing line

M.Hakimollahi^{1,*}, S.G.Jalali Naini², M.Bagherpour³, S.Jafari⁴, A.Shahmoradi⁵

¹MSc Student, ^{2,3}Assistant Professor, Industrial Faculty, Iran University of Science and technology ⁴Assistant professor, Department of Mechanical Engineering, Damavand branch, Islamic Azad University, ⁵IKCo. Employee

Hakimelahi90@yahoo.com

Abstract

In recent years, the balanced score card (BSC) has been the focus of considerable methodology for strategic cost management in management accounting area since it was originally proposed by Kaplan ,R.S. and Norton, D.P. in 1992. BSC is an approach to performance measurement based on both financial and non-financial information from four perspectives which are called financial, customer, internal business process, and learning and growth, in order to balance the traditional financial performance system by several grouping of performance measures: short-term and long-term, internal and external, and current and future. Over time, it has been developed to a strategic management system from a comprehensive performance measure, and used in many organizations such as business, hospital, and autonomy in many countries. In this paper, we propose a general model based on BSC by introducing fuzzy inference mechanism. From this, specialists' knowledge and experience can be effectively reflected during the construction of the practical model. Then we illustrate a practical example for an Automotive Manufacturing Co.

Keywords: BSC model, Performance measurement, Fuzzy inference mechanism, measures and initiatives.

1. Introduction

To meet the diversified challenge in today, companies have to survive around intense global competition. The winner needs to make timely and accurate decision to respond the changes confronted with business environment .Executives understand that acquiring adequate information affects performance measurement for shaping their strategy. However, most measures are being inadequate for expressing today's business performance with continuous improvement and innovation. Traditional financial performance measures like return on investment and residual income used to be measured for performance measurement in US manufacturing companies. These measures worked well for assessing physical assets to help managers understand profit return in industrial era, but in 1980s, it pointed out that financial measures were inadequate under the situation in which US companies battled against foreign competitions, especially Japanese companies. Thus, several comparative researches on why we couldn't be more competitive and where the Japan's success comes from have been conducted. As a result,

the traditional measurement system keeping eyes on the short-term performance in the top-down organization was inappropriate to translate future strategy. It has not worked well for information era with the diversified competitive situations which are unlike in industrial era. Therefore, the critical factor to become a successful business today is how to shift the performance from focusing on equipment investment for profit return to additionally enhancement of employee skills and enrich of organizational culture for being a knowledgeable organization. That is, the ability to exploit intangible assets has become more decisive than the ability to invest and manage the physical assets. Needless to say, companies should be measured by a comprehensive measurement system from not only financial assessing, but also the other perspectives customer, internal business process and learning and growth. BSC was first articulated in 1992 as a comprehensive framework that translates a company's strategy objectives into a coherent set of performance measures (Kaplan and Norton 1992). Then for doing this, BSC was proposed as a methodology to complement financial measures with operational measures based on non-financial

information (Matsuo 2005). Several companies have already adopted it as a strategic management system. There are several successful stories known in practical area from such companies as Motorola and Ricoh (Kaplan and Norton 1993; Matsuo 2005). Recently, although there has many researches in practical and academic area, practical studies tend to run ahead academic research. In this situation that theory and practical research are isolated, action research has been applied as an initiative to grope in both areas. In this paper, we aim to attempt a new approach of performance measurement based on BSC framework. In the approach, a fuzzy inference mechanism is introduced to reflect experience and knowledge decision makers have. From this, we can conduct the performance measurement in conformity with reality.

2. the BSC and the Measures

2.1 BSC Overview

BSC is a tool to structure measures from four perspectives, giving managers a comprehensive view of the business---short-term and long-term, financial and non-financial, as well as current and future to formulate vision and strategy. Its focus is on how to link the measures

with strategic activities from finance, customer, internal business process and learning and growth perspectives. Figure 1 shows the four perspectives of BSC (Kaplan and Norton 1996).

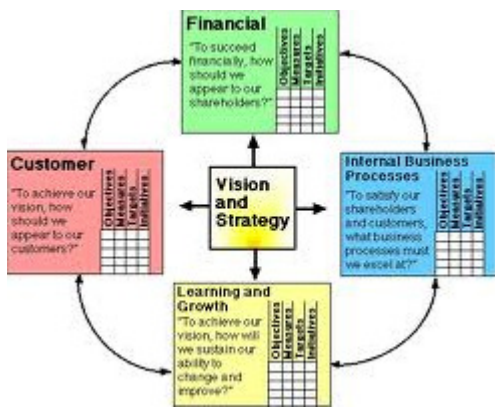

Fig1. Four perspectives of BSC: (Kaplan and Norton 1996)

It assumes that a linkage exist among the four perspectives which are not independent or parallel while translating vision and strategy. Generally, financial measures are the sole indicators of the company’s performance such as ROE and ROI.

However, to rise profit return needs to enrich customer satisfaction and loyalty, and to improve production processed shorten the time of delivery. For doing this, employees ‘skills need to be enhanced from learning and growth perspective. Therefore, the perspectives are seen in a cause-effect relation called vertical linkage.

2.2. A Measurement Framework

As shown in figure 1, in order to translate vision and strategy, objectives and targets are set and the measures and initiatives are designed and aligned by the nominal group techniques (Delbecq et al. 1975). Herein, the designed measures and aligned initiatives interrelate each other in a relation called horizontal linkage. In this paper, we attempt to present a suggestion of a measurement system based on BSC with introducing fuzzy inference (Matsuo 2006). The relations among measures of each perspective consist of as the followings:

(1) Financial Perspective the Measures and Initiatives

The Measures and Initiatives In financial measurement, cost reduction as a measure, and reduce the cost of Manufacturing and diversion of funds as initiatives. The relations among them are illustrated in figure 2.

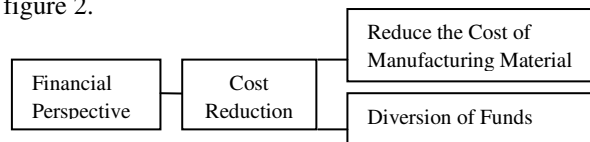

Fig2. Financial perspective: the measures and initiatives

(2) Customer Perspective: The Measures and Initiatives

According to customers’ concern, timely delivery of product and improve customer satisfaction of product quality can be designed as the measures. Since the fulfillment of production plan and CSI are as initiatives.

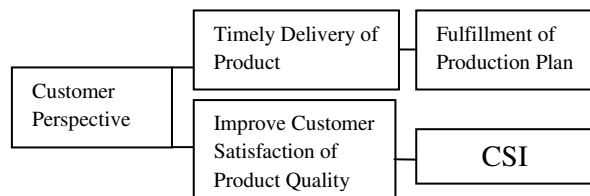

Fig3. Customer Perspective: the measures and initiative

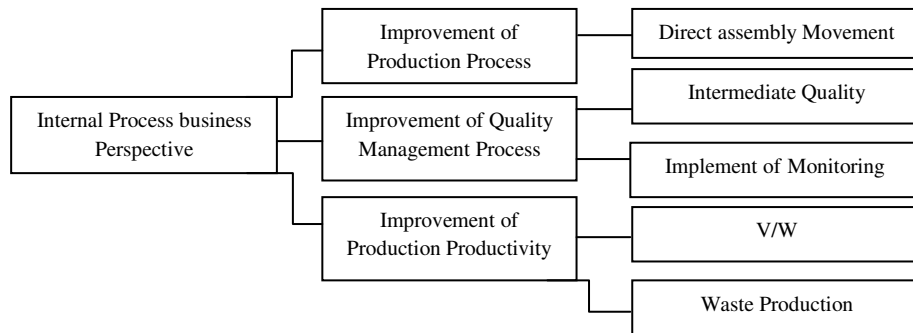

Fig4.Internal Process perspective: the measures and initiatives

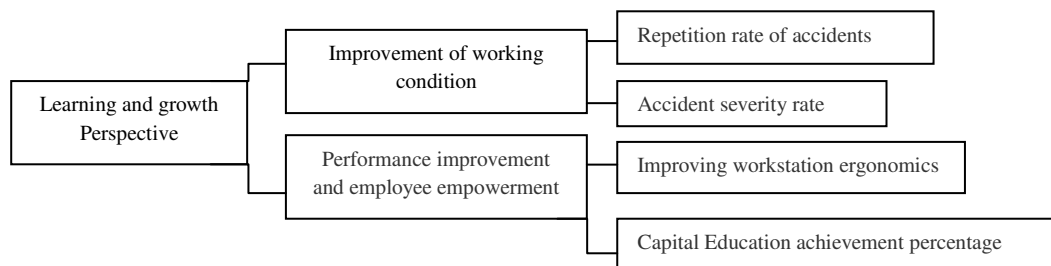

Fig5.Learning and growth perspective

(3) Internal Business Process: The Measures and Initiatives

As shown in figure below, The Measures and Initiatives In Internal Business measurement are, Improvement of Production Process, Improvement of Quality management Process and Improvement of production productivity as measurement and Direct assembly Movement, Intermediate Quality, Implement of Monitoring, V/W and Waste Production are as initiatives

(4) Learning and Growth Perspective: The Measures and Initiatives

Figure 5 illustrates the measures and initiatives designed from Learning and growth perspective. In order to improve internal process continuously, companies are required to keep training employee, as well as secure internal infrastructure. For doing this, they need to survey employee job satisfaction, enhance infrastructure, also raise research and development for long run.

Fuzzy inference is prepared for multi-dimensional measurement system of performance. The system is proposed to integrate the four perspective models to obtain an integrated value of evaluation. The important subject in the proposed system is how to reflect the understanding or know-how the evaluators have on the integrating process under the consideration of the changes happening in social and business environment, which is the characteristic of the proposed system. Therefore, although the evaluators have no theoretical understanding on the performance measurement, they are able to measure the performance specialist-likely through applying the system proposed in this paper. Generally, the fuzzy inference rule is expressed as follows: 'IF x is A1 and y is B1 THEN z is C1 else IF x is A2 and y is B2 THEN z is C2 else IF x is An and y is Bn THEN z is Cn else IF x is A' and y is B' THEN z is C' where each of A1,..., An, A' is subset of universe of discourse U , and B1 ,..., Bn , B' fuzzy subset of universe of discourse V ; C1 , ..., Cn ,C' subset of universe of discourse W. Here, we use several types of fuzzy number. Especially, we concentrate on the common types: triangular, trapezoidal, and Gaussian fuzzy numbers. (Inoue and Amagasa 1998).

3. Fuzzy Inference Mechanism

4. BSC with Fuzzy Inference

Fuzzy inference rules for performance measurement are constituted on the basis of the knowledge and experience of specialists or evaluators. Therefore, no matter the evaluator is specialist of performance measurement or not, they enable to conduct measurement of performance specialists-likely. In this section, BSC with the fuzzy inference is empirically constructed.

5. goals and achievement

By having measure and initiative, the relating office need to this initiative has been selected and the interview was done to recognize the goals and achievements. At below you may see the Initiative liable.

6. Rules and Membership Function

6.1. Rules and Membership Function for Financial Perspective

Table 2 shows financial perspective with Cost

reduction as the measure consisting of the initiatives; Reduce the cost of manufacturing and diversion of funds .Weights are given by a set of terms{ high (Hi), high a little (Ha), standard (St), low a little (La),low (Lo) }, for instance, when the weight is about [0, 0.2),the weight is shown by “Lo”, and similarly about [0.2,0.4)“La”, about [0.4, 0.6) “St”, about (0.6,0.8] “Ha”, about (0.8,1.0] “Hi” semantically. Just in diversion of cost this system is vice versa.

(a)H is the set of 5 evaluation values for reduce the cost of manufacturing and diversion of funds denoted as follows: $H = \{high, high\ a\ little, standard, low\ a\ little, low\}$

(b) Fuzzy inference rule denoted by R_i , ($i= 1,2,\dots,25$) for cost reduction measure.

If (input1 is mf1) and (input2 is mf1) then (output1 is mf3) these existing condition has come out by doing interview with the head of relating Department.

6.2. Rules and Membership Function for Customer Perspective

Table 3 shows customer perspective with two measures, Timely delivery of product and Improve Customer Satisfaction of Product Quality is consisted of two initiatives, Fulfillment of production plan and

Table 1: Initiative Liable

Perspective	Measure	Initiative	Initiative liable
Financial	Cost Reduction	Reduce the cost of Manufacturing	Engineering Management
		Diversion of Cost	Financial Management
Customer	Timely delivery of product	Fulfillment of production plan	Logan Comprehensive system
	Improve Customer Satisfaction of Product Quality	CSI	Quality Management
Internal Process	Process Improvement	Direct Production line	Manufacturing management
	quality management Improvement	Intermediate quality	Quality Management
		Monitoring	Quality Management
	Increase productivity	v/w	Engineering Management
Waste production		Manufacturing Management	
Learning and Growth	working condition Improvement	Repetition rate of accident	Human resource office
		accident severity rate	Human resource office
		accident severity rate	Human resource office
	employee Empowerment	Improving workstation ergonomics	Human resource office

CSI. H is the set of 5 evaluation values for each of, Timely delivery of product and Improve Customer Satisfaction of Product Quality denoted as follows:

- (a) H = {high, high a little, standard, low a little, low }
- (b) Inference rule denoted by Ri, (i=1, 2... 25) for internal process perspective.

6.3. Rules and Membership Function for Internal Process Perspective

Table 4 shows the internal perspective with Process Improvement, quality management Improvement and Increase productivity as the measures, which consist of initiatives, that is, Direct Production line, Intermediate quality, Monitoring, V/W and waste production. (a) H is the set of 5 evaluation value is denoted as follows: H = { high,

high a little, standard, low a little, low } (b) Inference rule denoted by Ri ,(i=1,2,...,125) for internal process perspective.

6.4. Rules and Membership Function for Learning and Growth Perspective

Table 4 shows the learning and growth perspective with working condition Improvement and employee Empowerment as the measures consisting of sets of initiatives, Repetition rate of accident, accident severity rate and Improving workstation ergonomics.(a) H is the set of 5 values that is described as follows' = { high, high a little, standard, low a little, low }

(b) Inference rule for learning and growth denoted by Ri, (i= 1, 2... 25).

Table 2 financial perspective, measures and initiatives

Perspective	Measure	Initiative	Goals	achievement
Financial	Cost Reduction	Reduce the cost of Manufacturing	Reduce 1.000.000 RLS	Reduce up to 560.000 RLS
		Diversion of Cost	0 %	0%

Table 3: Customer perspective: measures and initiatives

Perspective	Measure	Initiative	goals	Achievement
Customer	Timely delivery of product	Fulfillment of production plan	38.31	31.77
	Improve Customer Satisfaction of Product Quality	CSI	74.5	72

Table4: Internal process perspective: measures and initiatives

Perspective	Measure	Initiative	goals	Achievement
Internal Process	Process Improvement	Direct Production line	85%	89.3%
		quality management Improvement	1.49	2.44
	Increase productivity	Monitoring	100%	83%
		v/w	45	32.5
		Waste production	46.6	20.28

Table 5 Learning and growth perspective: measures and initiatives

Perspective	Measure	Initiative	goals	achievement
Learning and Growth	working condition Improvement	Repetition rate of accident	22	26.61
		accident severity rate	0.38	0.38
		accident severity rate	3.2	3.2
	employee Empowerment	Improving workstation ergonomics	3.1	3.1

7. Illustrative example

The membership functions and the inference rules with of Logan are formulated based on the models

described before. In practical sense, their membership functions and the inference rule are formulated by the specialists.

Here they are some model to be review

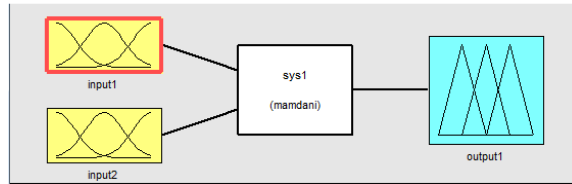

Fig6. Measurement model of financial perspective

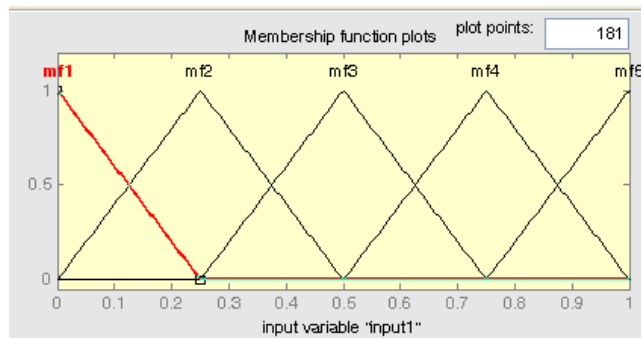

Fig7. Membership function of input one

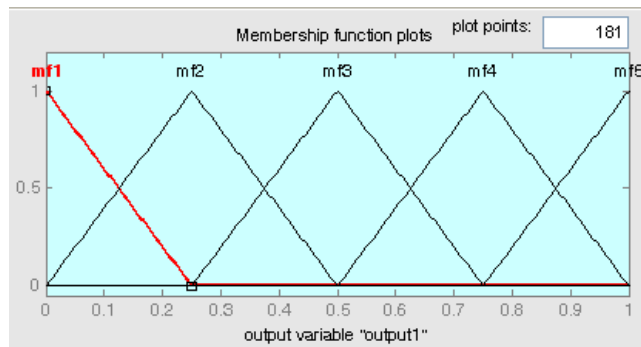

Fig8. Membership function of financial perspective out put

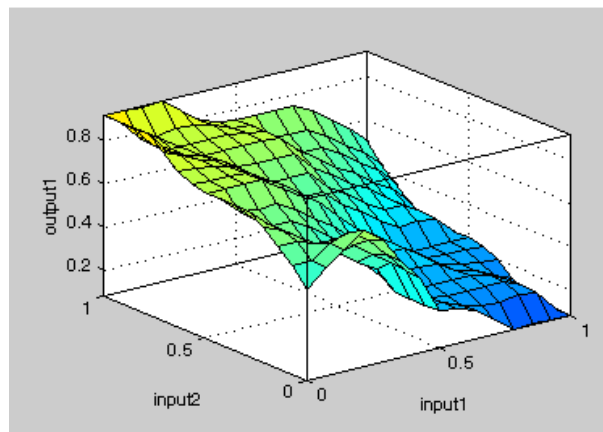

Fig9. Surface of Financial perspective

8. Integration of Four Perspectives

To integrate we made an Algorithm system for all four perspectives and the chart is given as below.

By running this Algorithm system we can have the results for each perspective and also the average of them.

9. Results

The result is shown that this automotive production line has achieved 94.77% to its goals.

Table 6. Final achievements

Goals	Achievements
financial perspectives	89.39%
Customer Perspectives	97.51%
Internal Process Perspectives	99.15%
Learning and Growth perspective	100%
total achievement	94.77%

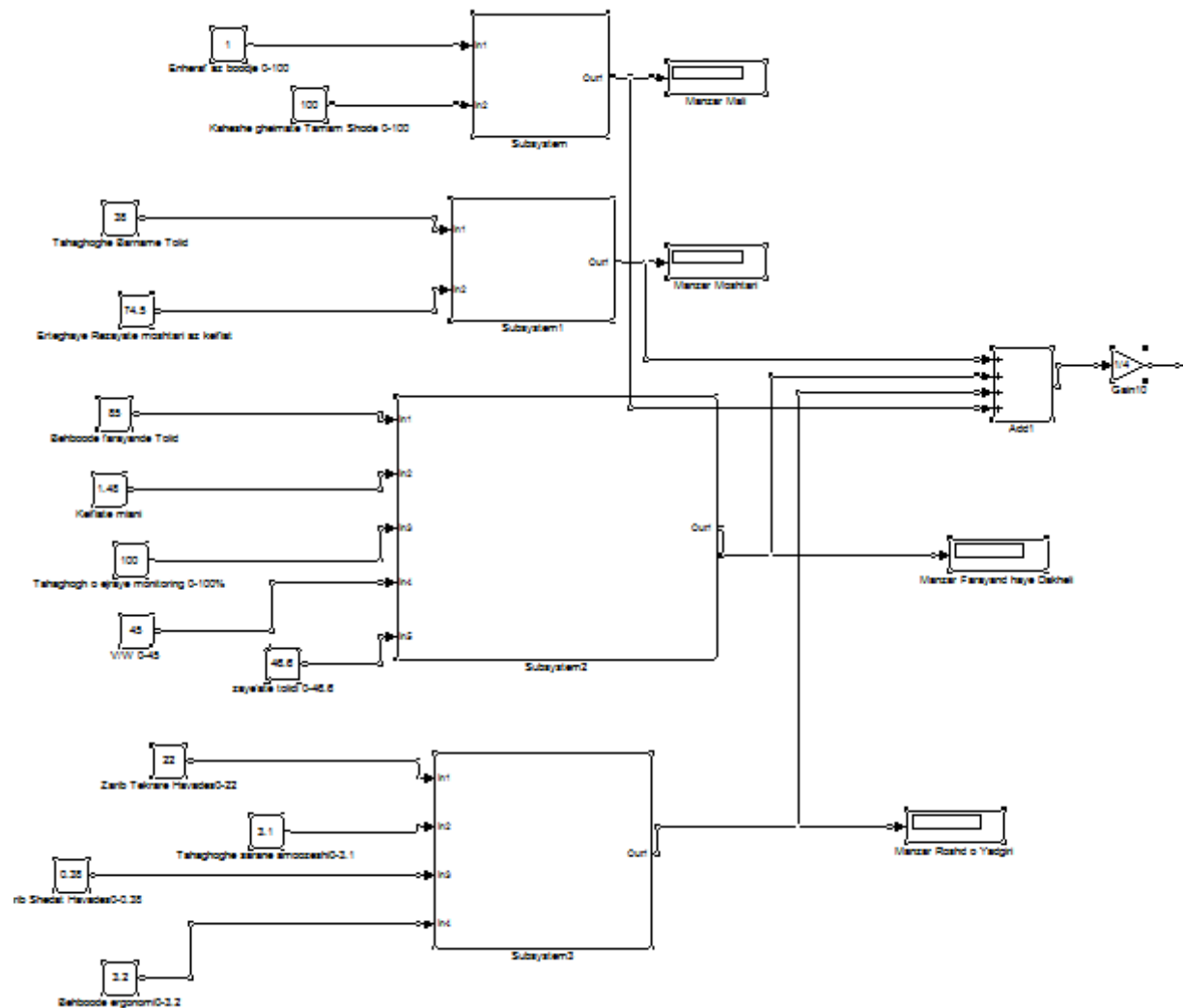

Fig10. Integrated system of four perspective

10. Conclusions

In this paper, as the performance measurement we proposed an approach based on the balanced scorecard with the fuzzy inference mechanism, which integrates the performance measurement from each of finance, customer, internal business and learning and growth perspective. Further in order to inspect the validity of the approach, we applied it to an illustrative problem, which is, inspecting the performance of the Automotive manufacturing lines. As the result, the following points are cleared.

(1) The characteristic of f-Bsc measurement system of performance assure the process to reflect Specialists' knowledge and/or know-how on the system. Further evaluators can integrate the evaluation value from each perspective effectively and contingently under the dynamic social and business environment;

(2) The evaluators no matter who even do not understand the context of the given measurement problem theoretically enable to measure performance specialist-likely;

(3) We focus on the formulation of membership function and rules for measuring and integrating the rational value for performance measurement. However, several simulation issues need to be solved in the future.

(4) We used MATLAB to construct the performance measurement system based on BSC with the fuzzy inference.

REFERENCES

- [1]. Abegglen, J.C. and Stalk, G.Jr. (1985) KAISHA, Basic Books Inc.
- [2]. Amagasa, M. (2004), Management Systems Engineering, Institute of Business Research, Daito-Bunka University, Vol.22, pp133/174
- [3]. Delbecq, A.L. Andrew H.Vande Ven and Gustafson, H. David (1975) Group Techniques for Program Planning- a guide to nominal group and Delphi processes, Scot, Foresman and Company.
- [4]. Dertouzos, M.L.et.al.(1989), Made in America, The MIT Press.
- [5]. Inoue, H. and Amagasa, M.,(1998), Fundamentals of Fuzzy Theory, (in Japanes), Asakura Shoten, pp.57/66
- [6]. Kaplan, R.S.and Norton, D.P. (1992)“The Balanced Scorecard : Measures that Drive Performance,” Harvard
- [7]. Business Review, Vol.70, No.1, January-February, pp.71-79. Kaplan, R.S. and Norton, D.P. (1993) “Putting the
- [8]. Balanced Scorecard to Work,” Harvard Business Review, September-October, pp.134-147.
- [9]. Kaplan, R.S.and Norton, D.P. (1996) Balanced Scorecard, Harvard Business School Press.
- [10]. Matsuo, T. (2005), “Implication of Balanced Scorecard as Management Accounting tool,” Research Papers (Institute of Business Research Daito Bunka University), №J-46.
- [11]. Matsuo, T. (2006), A new perspective of Management Accounting, Institute of Business Research Daito Bunka
- [12]. University, Vol.24.Womack, e J.P.t.al (1990), the Machine That Change The World, Macmillan Publishing Company.
- [13]. Zadeh, L.A. (1965) Fuzzy Set, Information and Control, Vol.8, pp.338/353