

# Roll vibration control for a Full vehicle Model Using Vibration Absorber

A. Hemati<sup>1\*</sup>, M. Tajdari<sup>2</sup>, A. R. Khoogar<sup>3</sup>

1-Malek-e-Ashtar University of Technology 2-Department of Mechanical Research, Islamic Azad University, Science and Research Branch, Arak, Iran 3-Malek-e-Ashtar University of Technology

A\_hemati65@yahoo.com

## Abstract

This paper presents a reduce roll vibration of the full vehicle model with passive suspension systems using vibration absorber to change the dynamic system matrix state's eigenvalue. Since using the controller system has been splurged and required to energy consuming, in this research the vehicle body roll vibration has been reduced and supplied vehicle stability using a vibration absorber for the passive suspension system. In this paper a new manner is introduced to reduce body roll angle and body's roll acceleration. The transverse instability in the independent suspension is a main problem; roll angle decreased transverse stability, that it has been reduced using vibration absorber. The optimal value of vibration absorber's mass, spring and damping coefficient has been determined by using genetic algorithms (GA) to achieve developed roll angle behavior. The main purpose of this article is to reduce vehicle body roll angle that has been acquired using vibration absorber, this manner is better than other ways for roll reduction of vehicle body because it has done without any energy consuming.

**Keywords:** Full vehicle model, Vibration absorber, Genetic algorithm, Passive suspension

## 1. Introduction

Vehicle passive suspension system and vibration absorber have been improved. Vibration damping through the passive suspension and seat will not provide optimal roll riding comfort. One can simulate a vehicle vibration in three ways. The first method is to study 1/4 vehicle vibration. The second method is to study 1/2 vehicle vibration, and the last one would be studying the full models of vehicle vibration. In this study, the roll angle and acceleration using vibration absorber and parameter optimization has been acquired through genetic algorithms. Suspension system during the vehicle simulation justifies the amount of unfavorable vehicle body movements. The periodical non-linear dynamic of the suspension model changes based on the Newton and Lagrange's formulas. In order to be able to use the state space formulations, as well as enjoying such advantages like applications on multi variable systems, and ease of operations and manipulations - in the next stage the nonlinear system

has been replaced by an equivalent linear system. In this paper, the simulations have been done by the MATLAB and the SIMULINK toolboxes. The most research of controlling vibration has been done to reduce a body and driver's seat vibration. The purpose of [1] is to estimate accurately the vehicle attitudes, i.e. the vehicle roll and pitch angles. It assumes that a set of data obtained from a low-price six-dimensional inertial measurement unit is available. This includes the linear acceleration of the vehicle and the angular rates of all axes. Only roll rate sensor and the sensors readily available on vehicles equipped with ESC (Electronic Stability Control) systems are used in the estimation process [2]. The optimal control of switched linear autonomous systems with quadratic performance index over an infinite time horizon is considered [3]. In [4] presents the design of a robust linear controller for an active suspension mounted in a quarter car test-rig. [5] Is concerned with an active suspension system for the motor coaches, using a "skyhook" damper and fuzzy logic control. In [6], an overview and a benchmark of

some semi-active suspension control strategy performances are proposed. In [7] developed a gray-prediction self-organizing fuzzy controller (GPSOFC) for active suspension systems. The GPSOFC introduces a grey-prediction algorithm into an SOFC, in order to pre-correct its fuzzy rules for the control of active suspension systems. It presents a parameter-dependent controller design approach for vehicle active suspensions to deal with changes in the vehicle inertial properties and existence of actuator time delays [8]. [9] Proposes a non-linear pitch-plane model, to be used for the gradient information, when optimizing ride comfort. [10] Presents an electromechanical wheel suspension, where the upper arm of the suspension has been provided with an electric leveling and a damper actuator, both are allowed to work in a fully active mode. Thus far, different methods have been used to control 1/4 body vibration [11]. The results obtained after the suspension system analysis, which is referred to, as mass-spring-damper system and proved to have initiated modes of excitation, is presented in the reference [12]. In [13] genetic algorithm (GA) method is applied to the optimization problem of a linear one degree-of-freedom (1-DOF) vibration isolator mount, and the method is extended to the optimization of a linear quarter car suspension model Neural network based robust control system is designed to control vibration of vehicle suspensions for full-suspension system [14]. [15] Presents the possibility of using slow active suspension control to reduce the body roll and thus reduce the rollover propensity. [16] Presents the design of an active roll

controller for a vehicle and an experimental study using the electrically actuating roll control system. The roll steers of a front McPherson suspension system are studied and the design characteristics of mechanism are optimized using Genetic Algorithm method [17]. Optimization of a four-degrees-of-freedom quarter car seat and suspension system using genetic algorithms to determine a set of parameters to achieve the best performance of the driver has been presents in [18]. In this paper, the roll angle of the vehicle has been reduced using vibration absorber and vibration absorber's parameters have been determined using the GA method.

### 2. Vehicle Mathematical Modeling

A full-vehicle model with passive suspension is shown in Figure 1. It is an eight-degree-of-freedom model, which consists of vertical motion, pitch, and roll modes of the sprung mass, vertical motions of the front suspensions, the rear suspension and the driver's seat. For simplicity, the pitch and roll angle have been assumed to be small. The suspensions are between the sprung mass and unsprung mass that are modeled as linear spring elements, while the tires are modeled as simple linear springs without dampers. Furthermore, the damper is divided into two parts, which are the damper with fixed damping coefficient and the one with a variable damping coefficient. The damper has fixed damping coefficient here. The vibration absorber that be used to reduce roll angle and acceleration have three degrees of freedom.

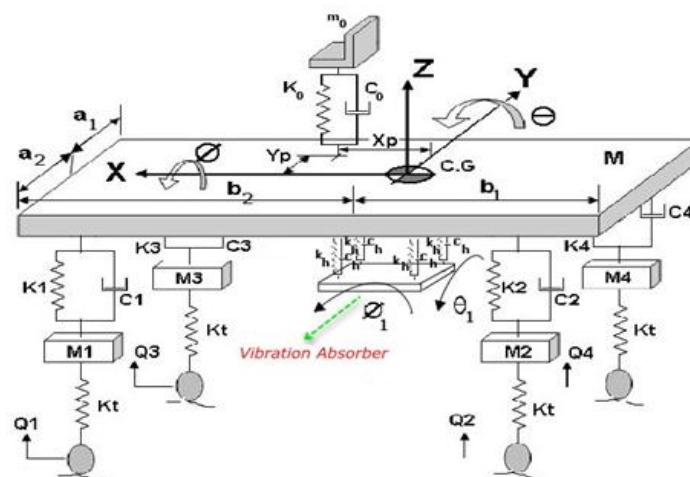

Fig1. Full vehicle model with a vibration absorber

The differential equations of body and suspension motion are derived by using Newton's laws of motion as follows:

$$m[\ddot{x}] + C[\dot{x}] + K[x] = f \tag{1}$$

$$m\ddot{x} + c_f(\dot{x} - \dot{x}_1 - a_1\dot{\theta} + b_1\dot{\phi}) + c_r(\dot{x} - \dot{x}_2 - a_2\dot{\theta} - b_2\dot{\phi}) + c_r(\dot{x} - \dot{x}_3 + a_2\dot{\theta} + b_1\dot{\phi}) + c_r(\dot{x} - \dot{x}_4 + a_2\dot{\theta} - b_2\dot{\phi}) + c_0(\dot{x} - \dot{x}_0 + a_2\dot{\theta} - b_2\dot{\phi}) + k_f(x - x_1 - a_1\theta + b_1\phi) + k_f(x - x_2 - a_1\theta - b_2\phi) + k_r(x - x_3 + a_2\theta + b_1\phi) + k_r(x - x_4 + a_2\theta - b_2\phi) + k_0(x - x_0 + a_2\theta - b_2\phi) + k_h(x - x_h) = f_f + f_r + f_r + f_r \tag{2}$$

$$I_y\ddot{\theta} - c_f a_1(\dot{x} - \dot{x}_1 - a_1\dot{\theta} + b_1\dot{\phi}) - c_r a_1(\dot{x} - \dot{x}_2 - a_2\dot{\theta} - b_2\dot{\phi}) + c_r a_2(\dot{x} - \dot{x}_3 + a_2\dot{\theta} + b_1\dot{\phi}) + c_r a_2(\dot{x} - \dot{x}_4 + a_2\dot{\theta} - b_2\dot{\phi}) + c_0 a_2(\dot{x} - \dot{x}_0 + a_2\dot{\theta} - b_2\dot{\phi}) - k_f a_1(x - x_1 - a_1\theta + b_1\phi) - k_r a_1(x - x_2 - a_1\theta - b_2\phi) + k_r a_2(x - x_3 + a_2\theta + b_1\phi) + k_r a_2(x - x_4 + a_2\theta - b_2\phi) + k_0 a_2(x - x_0 + a_2\theta - b_2\phi) = -f_f a_1 - f_r a_1 + f_r a_2 + f_r a_2 \tag{3}$$

$$I_x\ddot{\phi} + c_f b_1(\dot{x} - \dot{x}_1 - a_1\dot{\theta} + b_1\dot{\phi}) + c_f b_1(\dot{x} - \dot{x}_1 - a_1\dot{\theta} + b_1\dot{\phi}) - c_r b_2(\dot{x} - \dot{x}_2 - a_2\dot{\theta} - b_2\dot{\phi}) + c_r b_1(\dot{x} - \dot{x}_3 + a_2\dot{\theta} + b_1\dot{\phi}) - c_r b_2(\dot{x} - \dot{x}_4 + a_2\dot{\theta} - b_2\dot{\phi}) - c_0 b_2(\dot{x} - \dot{x}_0 + a_2\dot{\theta} - b_2\dot{\phi}) + k_f b_1(x - x_1 - a_1\theta + b_1\phi) - k_f b_2(x - x_2 - a_1\theta - b_2\phi) + k_r b_1(x - x_3 + a_2\theta + b_1\phi) - k_r b_2(x - x_4 + a_2\theta - b_2\phi) - k_0 b_2(x - x_0 + a_2\theta - b_2\phi) = f_f b_1 - f_r b_2 + f_r b_1 - f_r b_2 \tag{4}$$

$$m_1\ddot{x}_1 - c_f(\dot{x} - \dot{x}_1 - a_1\dot{\theta} + b_1\dot{\phi}) - k_f(x - x_1 - a_1\theta + b_1\phi) + k_{yf}(y_1 - x_1) = f_1 \tag{5}$$

$$m_2\ddot{x}_2 - c_f(\dot{x} - \dot{x}_2 - a_2\dot{\theta} - b_2\dot{\phi}) - k_f(x - x_2 - a_2\theta - b_2\phi) + k_{yf}(y_2 - x_2) = f_2 \tag{6}$$

$$m_3\ddot{x}_3 - c_r(\dot{x} - \dot{x}_3 + a_2\dot{\theta} + b_1\dot{\phi}) - k_r(x - x_3 + a_2\theta + b_1\phi) + k_{tr}(y_3 - x_3) = f_3 \tag{7}$$

$$m_4\ddot{x}_4 - c_r(\dot{x} - \dot{x}_4 + a_2\dot{\theta} - b_2\dot{\phi}) - k_r(x - x_4 + a_2\theta - b_2\phi) + k_{tr}(y_4 - x_4) = f_4 \tag{8}$$

$$m_0\ddot{x}_0 - c_0(\dot{x} - \dot{x}_0 + a_2\dot{\theta} - b_2\dot{\phi}) - k_0(x - x_0 + a_2\theta - b_2\phi) = 0 \tag{9}$$

The vibration absorber equation is shown as follow;

$$m_h\ddot{x}_h - 4.c_h(\dot{x}_1 - \dot{x}_h - (2.b_3 - 2.b_4)\dot{\phi}_1 - (2.b_3 - 2.b_4)\dot{\theta}_1) - 4.k_h(x_1 - x_h - (2.b_3 - 2.b_4)\phi_1 - (2.b_3 - 2.b_4)\theta_1) = 0 \tag{10}$$

$$I_u\ddot{\phi}_2 - 4.c_h.(2.b_3 - 2.b_4).(\dot{x}_1 - \dot{x}_h - (2.b_3 - 2.b_4)\dot{\phi}_1 - (2.a_3 - 2.a_4)\dot{\theta}_1) - 4.k_h.(2.a_3 - 2.a_4).(x_1 - x_h - (2.b_3 - 2.b_4)\phi_1 - (2.a_3 - 2.a_4)\theta_1) = 0 \tag{11}$$

$$I_r\ddot{\theta}_2 - 4.c_h.(2.a_3 - 2.a_4).(\dot{x}_1 - \dot{x}_h - (2.b_3 - 2.b_4)\dot{\phi}_1 - (2.a_3 - 2.a_4)\dot{\theta}_1) - 4.k_h.(2.a_3 - 2.a_4).(x_1 - x_h - (2.b_3 - 2.b_4)\phi_1 - (2.a_3 - 2.a_4)\theta_1) = 0 \tag{12}$$

The full vehicle parameters that used for simulation are shown in table 1.

### 3. Vibration Absorbers

Large amplitude steady-state vibrations exist when a system is subject to a harmonic or random excitation whose frequency of excitation is near the natural frequency of the system. The steady-state amplitude can be reduced by changing the system configuration by the addition of a vibration absorber, an auxiliary mass-spring system illustrated in Figure 2. The addition of a vibration absorber adds 3 degree of freedom to the system and shifts the natural frequencies away from the excitation frequency. The lower of the new system's natural frequencies is less than the natural frequency of the primary system while the higher natural frequency is greater than the natural frequency of the primary system.

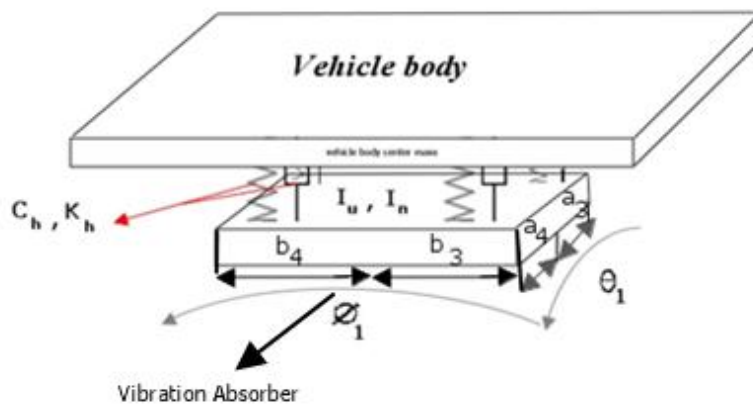

Fig2. Vibration absorber in center mass of the vehicle body

**Table1.** Full Model Vehicle Parameters

<i>Parameter</i>	<i>Symbol</i>	<i>Value</i>
Mass of the vehicle body	$m$	840 kg
Un sprung mass in front left/right side	$m_f$	53 kg
Un sprung mass at rear side	$m_r$	76 kg
Distance between front wheel and full-vehicle model at its mass center	$a_1$	1.4 m
Distance between rear wheel and full-vehicle model at its mass center	$a_2$	1.47 m
Spring constant of front suspension	$k_f$	10000 N/m
Spring constant of rear suspension	$k_r$	10000 N/m
Spring constant of front tire	$k_{tf}$	200000 N/m
Spring constant of rear tire	$k_{tr}$	200000 N/m
Fixed damping coefficient of the front suspension damper	$c_f$	2000 N.s/m
Fixed damping coefficient of the rear suspension damper	$c_r$	2000 N.s/m
Distance between front and rear right side wheel and full-vehicle model at its mass center	$b_1$	0.7 m
The distance between front and rear left side wheel and full-vehicle model at its mass center	$b_2$	0.75 m
Roll moment of inertia of the vehicle body	$I_x$	820 kgm <sup>2</sup>
Pitch moment of inertia of the vehicle body	$I_y$	1100 kgm <sup>2</sup>
Pitch angle of the vehicle body	$\theta$	Variable
Roll angle of the vehicle body	$\varphi$	Variable
Vehicle body vertical motion	$x$	Variable
Spring constant of Driver's seat	$k_o$	1200 N/m
Fixed damping coefficient of the constancy of the Driver's seat	$c_o$	400N. s/m
Mass of the Driver's seat	$m_0$	80 kg
Mass of the vibration absorber	$m_h$	2 kg
Spring constant of the vibration absorber	$k_h$	5N/m
Roll moment of inertia of the vibration absorber	$I_n$	100 kgm <sup>2</sup>
Pitch moment of inertia of the vibration absorber	$I_u$	150 kgm <sup>2</sup>
Distance between front side and vibration absorber at its mass center	$b_3$	0.05 m
Distance between rear side and vibration absorber at its mass center	$b_4$	0.1 m
Distance between right side and vibration absorber at its mass center	$a_3$	0.05 m
Distance between left side and vibration absorber at its mass center	$a_4$	0.05 m
Pitch angle of the vehicle body	$\phi_1$	variable
Roll angle of the vibration absorber	$\theta_1$	variable
Vibration absorber vertical motion	$x_h$	Variable

**4. Genetic Algorithm**

The vibration absorber parameters have been obtained by using genetic algorithm. The objective function of the GA is roll angle and roll acceleration. The result of optimal simulation has been determined by the GA method. Figure 3 shown the global search for obtaining of vibration absorber parameters.

The vibration absorber's parameters have been determined by the best fitness using the GA method

The roll angle and acceleration are objective function, then the vibration absorber parameters obtaining base on best fitness of roll angle and acceleration. The result of the GA method simulation is shown in Table 2.

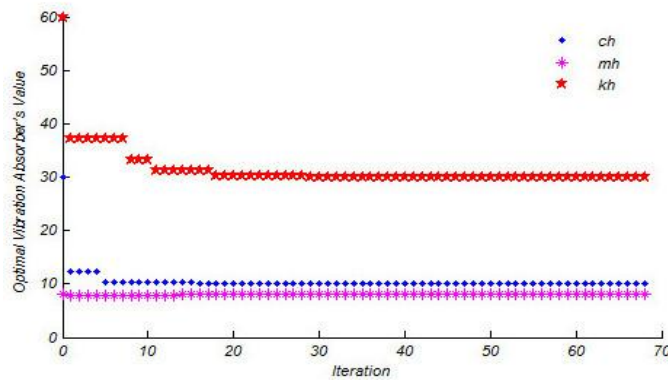

Fig3. Value of vibration absorber simulation curve using GA

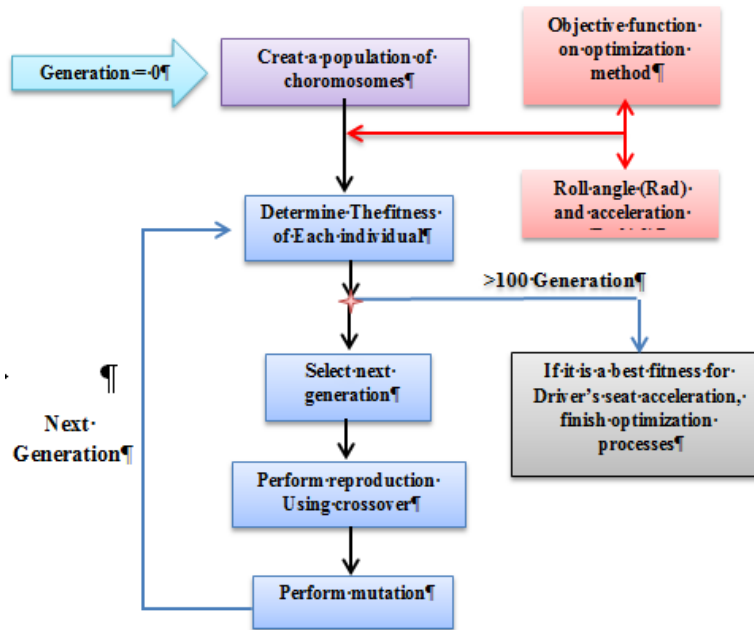
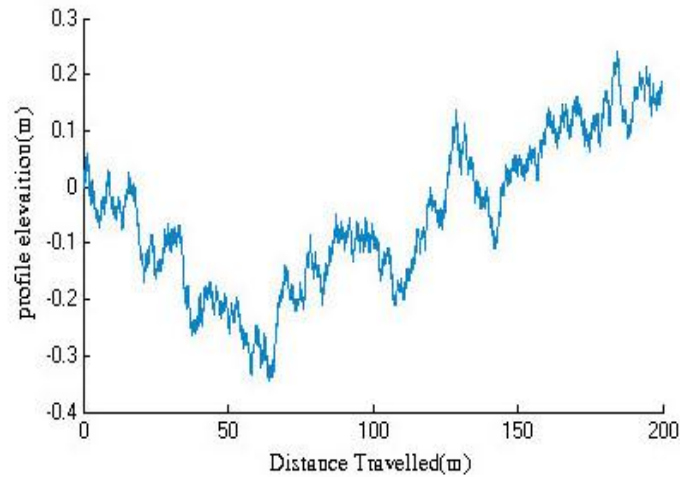

Fig4. The GA method flowchart

**Table 1.** Vibration Absorber Parameters Using GA Search

Parameters	Lower Bound	GA method	Upper Bound	Unit of Measure
$m_h$	1	8	10	Kg
$k_h$	5	30	100	N/m
$c_h$	2	10	80	N.s/m



**Fig5.** Input Pavement simulation curve

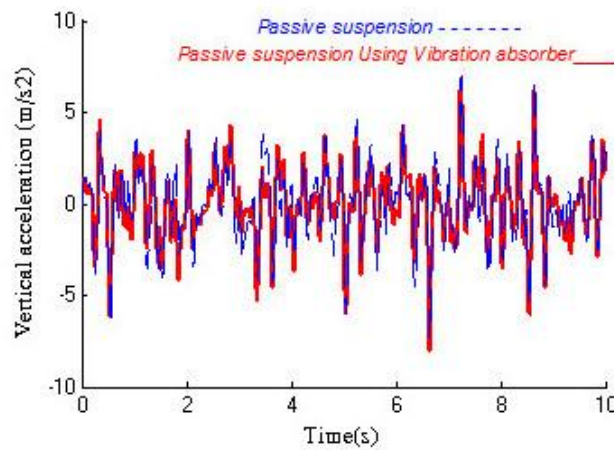
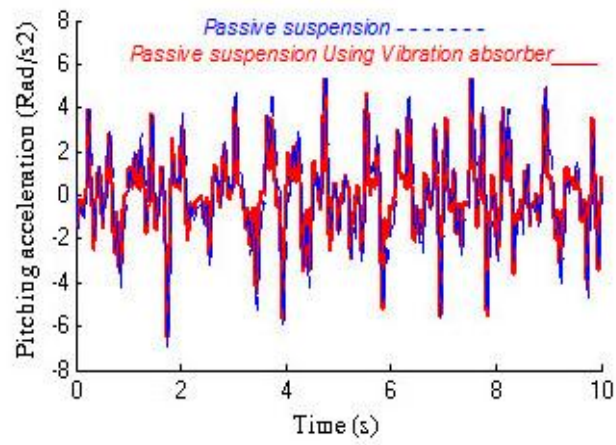

**Fig6.** Body vertical acceleration simulation curve

**5. Simulation Results**

In this paper, the research object is a certain kind of vehicle. Input pavement using as the approximate cost is shown in figure 5 for a 200m distance. Vehicle’s running speed is 80km/h in this simulation so it simulation can compare to [19] for passive

Suspension simulation output for a same speed. Figure 6, Figure 7, Figure 8, Figure 9 and Figure 10 are body vertical acceleration, body pitch acceleration, body roll acceleration, driver’s seat acceleration and body roll angle, respectively. The chart of simulation in MATLAB/SIMULINK is shown in Figure 11.



**Fig7.**Body pitch acceleration simulation curve

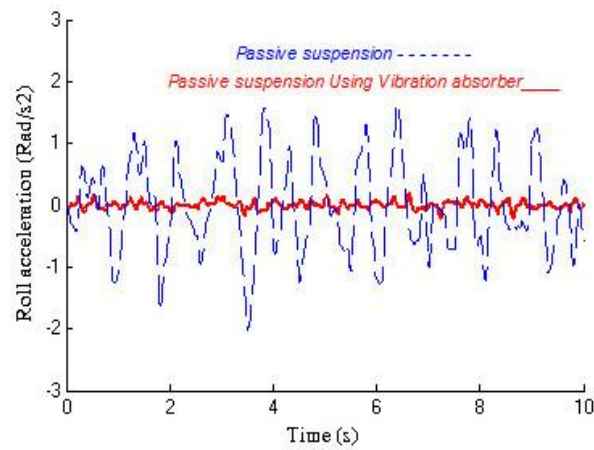

**Fig8.**Body roll acceleration simulation curve

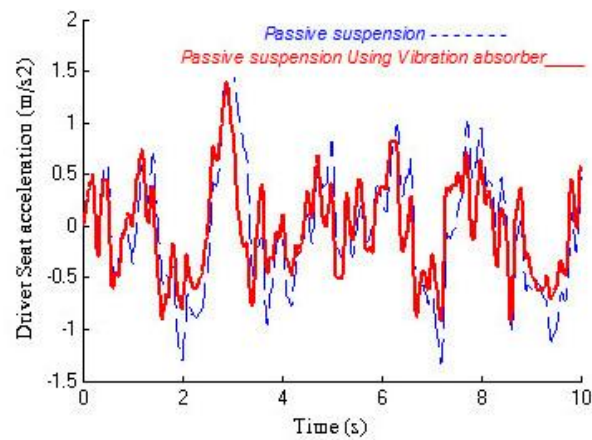

**Fig9.**Driver's seat acceleration simulation curve

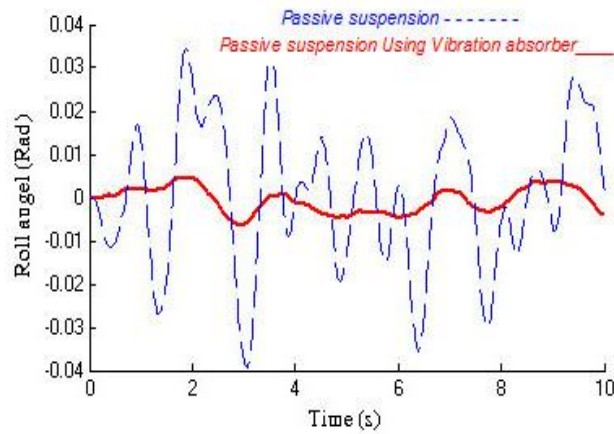

Fig10. Body roll angle simulation curve

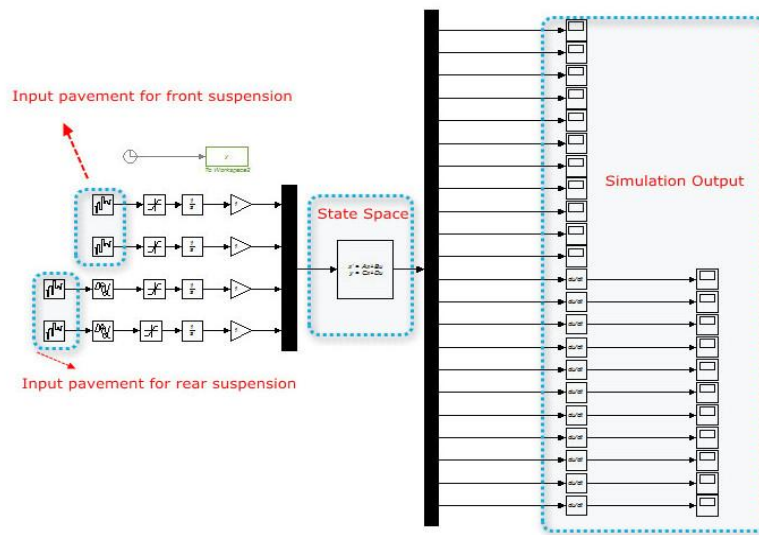

Fig11. Curve of simulation in MATLAB/SIMULINK

Table 2. The Full Vehicle Model Performance in 80km/h

Performance		Passive suspension using vibration absorber	Passive suspension
Body Vertical Acceleration	$\frac{m}{s^2}$	8	8
Body Pitch Acceleration	$\frac{Rad}{s^2}$	6	6
Body Roll Acceleration	$\frac{Rad}{s^2}$	0.2	1
Driver's Seat Vertical Acceleration	$\frac{m}{s^2}$	1.3	1.5
Roll Angle	Rad (deg)	0.005(0.2866)	0.04 (2.3)



The simulation results of vehicle performance with passive suspension and passive suspension using vibration absorber are shown in Figure 12.

The simulation of passive suspension has shown the vehicle unfavorable performance. The passive suspension by using vibration absorber improved body transverse stability. Roll angle for passive suspension is 0.04 (Rad) that by using a vibration absorber, it has been reduced to 0.005 (Rad). This simulation illustrated vibration absorber performance to reduce roll vibration. This simulation presents a good behavior of the vehicle roll, when it is using a vibration absorber.

## 6. Conclusion

The mathematical modeling is based on simulation. Vehicle body roll angle and acceleration have been reduced by using vibration absorber. It is shown that using vibration absorber is a good manner to roll control. Using a sprung mass with 3 degrees of freedom as a vibration absorber, vehicle body roll angle and acceleration have been reduced without any energy consuming. The vehicle body roll angle and acceleration are an objective function of the GA design to achieve ideal vibration absorber's parameters. The passive suspension using vibration absorber, improved body transverse stability. Roll angle for the vehicle with passive suspension has decreased with vibration absorber. Object of using vibration absorber is reduction of the body roll angle; in a result it has been achieved.

## References

- [1]. Jiwon Oh, Seibum B Choi, Vehicle roll and pitch angle estimation using a cost-effective six-dimensional inertial measurement unit, *journal of automotive engineering*, 227 (4) 577–590, IMechE 2013.
- [2]. Aleksander Hac, David Nichols and Daniel Sygnarowicz, Estimation of Vehicle Roll Angle and Side Slip for Crash Sensing, *SAE international journal*, 2010-01-0529.
- [3]. Daniele Corona, Alessandro Giua, Carla Seatzu, Optimal control of hybrid automata: design of a selective suspension, *journal of Control Engineering Practice* 12 (2004) 1305–1318.
- [4]. Christophe Lauwerys, Jan Swevers, Paul Sas, Robust linear control of an active suspension on a quarter car test-rig, *Control Engineering Practice* 13 (2005) 577–586.
- [5]. T. Yoshimura, Y. Isari, Q. Li and J. Hino, active suspension of motor coaches using skyhook damper and fuzzy logic control, *journal of Control Eng. Practice*, Vol. 5, No. 2, pp. 175–184, 1997
- [6]. Survey and performance evaluation on some automotive semi-active suspension control methods: A comparative study on a single-corner model C. Poussot-Vassal ,C. Spelta, O. Sename, S.M. Savaresi, L. dugard, *journal of annual Reviews in Control* 36 (2012) 148–160.
- [7]. systemsJeen Lin, Ruey-Jing Lian, Design of a grey-prediction self-organizing fuzzy controller for active suspension systems, *journal of Applied Soft Computing* xxx (2013) xxx–xxx
- [8]. Haiping Du, Nong Zhang, James Lam, Parameter-dependent input-delayed control of uncertain vehicle suspensions, *Journal of Sound and Vibration* 317 (2008) 537–556
- [9]. M.J. Thoresson, P.E. Uys, P.S. Els, J.A. Snyman, Efficient optimisation of a vehicle suspension system, using a gradient-based approximation method, Part 1: Mathematical modeling, *Mathematical and Computer Modelling* 50 (2009) 1421\_1436
- [10]. Mats Jonasson, Fredrik Roos, Design and evaluation of an active electromechanical wheel Suspension system, *Mechatronics* 18 (2008) 218–230
- [11]. Zifan Fang. Study of Control Method of Automotive Semi-active Suspension System Based on MR Damper]. Ph.D. Dissertation, Chongqing University, Chongqing, China, 2006.
- [12]. Ebrahimi, B., Bolandhemmat, H., Khamsee, M., and Golnaraghi, F," A hybrid electromagnetic shock absorber for active vehicle suspension systems" *journal of Taylor & Francis*, Issue 1-2,( 2011), 311-332
- [13]. R. Alkhatiba, G. Nakhaie Jazar, M.F. Golnaraghi, Optimal design of passive linear suspension using genetic algorithm, *journal of sound and vibration*275 (2004) 665–691
- [14]. Ikbal Eski, Sahin Yildirim, Vibration control of vehicle active suspension system using a new robust neural network control system, *Simulation Modeling Practice and Theory* 17 (2009) ,778–793
- [15]. Sarel F. van der Westhuizen, Pieter S. Els, Slow active suspension control for rollover prevention, *Journal of Terramechanics* 50 (2013), 29–36
- [16]. Hyo-Jun Kim , Young-Pil Park , Investigation of robust roll motion control considering varying speed and actuator dynamics, *journal of Mechatronics*, 14 (2004) ,35–54
- [17]. Hosein Habibi, Kourosh H. Shirazi , Mohammad Shishesaz, Roll steer minimization of McPherson-strut suspension system using genetic algorithm method, *Journal of Mechanism and Machine Theory* 43 (2008) ,57-67
- [18]. O. Gundogdu, Optimal seat and suspension design for a quarter car with driver model using genetic algorithms, *International Journal of Industrial Ergonomics* 37 (2007) ,327–332.
- [19]. XueMei Sun, Yaxu Chu ,Jiuchen Fan,Qiuxia Yang, Research of Simulation on the Effect of Suspension Damping on Vehicle Ride, *International Conference on Future Electrical Power and Energy Systems* ( 2012 ), 145 – 151