

A Genetic-Fuzzy Control Strategy for Parallel Hybrid Electric Vehicle

M. Bostanian¹, S. M. Barakati², B. Najjari¹, D. Mohebi Kalhori³

1. MSc Student Department of Mechanical Engineering, University of Sistan and Baluchestan 2. Assistant professor Department of Electrical and computer, University of Sistan and Baluchestan 3. Assistant professor Department of Chemical Engineering, University of Sistan and Baluchestan

Abstract

Hybrid Electric Vehicles (HEVs) are driven by two energy convertors, i.e., an Internal Combustion (IC) engine and an electric machine. To make powertrain of HEV as efficient as possible, proper management of the energy elements is essential. This task is completed by HEV controller, which splits power between the IC engine and Electric Motor (EM). In this paper, a Genetic-Fuzzy control strategy is employed to control the powertrain. Genetic-Fuzzy algorithm is a method in which parameters of a Fuzzy Logic Controller (FLC) are tuned by Genetic algorithm. The main target of control is to minimize two competing objectives, consisting of energy cost and emissions, simultaneously. In addition, a new method to consider variations of Battery State of Charge (SOC) in the optimization algorithm is proposed. The controller performances are verified over Urban Dynamometer Driving Cycle (UDDS) and New European Driving Cycle (NEDC). The results demonstrate the effectiveness of the proposed method in reducing energy cost and emissions without sacrificing vehicle performance.

Keywords: Hybrid electric vehicle, Genetic algorithm, Fuzzy logic controller, Energy cost

1. Introduction

Air pollution, global warming, and reduction of petroleum resources are dominant issues in automobile performance. Vehicles produce about one third of manmade carbon monoxide production along with many other harmful pollution sources, such as nitrous oxide and unburned hydrocarbons [1]. Environmental concerns have created an increasingly strong demand for fuel efficient vehicles to reduce emission, and reliance on fossil fuel. In general, there are two approaches that can be applied to reduce the fuel consumption and emission [2]: reducing losses, and increasing the efficiency of energy conversion. The first approach is about the dynamic efficiency of vehicles, while the second relates to the power train configuration. Development of hybrid powertrain as a solution can be defined as combination of conventional powertrain components into hybrid powertrain. The parallel HEV consists of an IC engine and an EM. The basic idea of HEV is to let the IC engine works in fuel and emission efficient region while using electric motor to provide for transient requirements [3].

Efficiency of parallel HEV is closely dependent on the vehicle control strategy which controls the amount of energy that flow between IC engine and EM. Montazeri and Asadi [4] partitioned hybrid control strategies into two main clusters including rule-based control strategy and optimization based control strategy. Sorrentinon et al. [5] studied the performance of a rule-based control strategy for series HEV and suitability of rule-based control strategy for series HEV was confirmed. A comparison of a conventional vehicle and a parallel HEV which employed a fuzzy rule-based control strategy was made by Hannoun and Diallo [6]. In their work the controller selected the proper power split between IC engine and EM. FLC also selected the best gear ratio at which the engine operated at the most fuel efficient mode. Mamdani type fuzzy model was used to design the FLC, and the reduction of fuel consumption was achieved as the result. Syed et al. [7] proposed a fuzzy rule based strategy which provided a feedback to the driver. The FLC automatically identified the driver's style and performance and provided guidance to the driver for selecting optimal driving strategy. The improvement in IC engine efficiency, fuel economy, and reduction of pollutant emissions were reported as the results. Zhang et al. [8] and Yuanwang

et al. [9] described the application of fuzzy logic control method in an off-road parallel HEV. The FLC splits the propulsion power between IC engine, and EM in normal driving mode, and the braking power between regenerative braking device and mechanical braking device in braking mode. Simulation results were provided to show the performance of the proposed system.

In this paper a fuzzy logic control strategy is introduced to reduce the energy cost, and emissions. The parameters of membership functions (MFs) in the fuzzy controller are tuned to minimize the energy cost and pollutant emissions. A new method, in which the variation of battery SOC is taken into account, is introduced.

The raining of the paper is organized as follows. Section two describes simulation platform. The control strategy is given in Section three. Section four describes FLC, and Section five dedicated to optimization of the controller. Simulation results are presented in Section six, Finally, the conclusion is explained in the last section.

2. Simulation Platform

Advanced vehicle simulator called ADVISOR, which is one of the most popular HEV simulators, is used as the simulation tool in this paper. ADVISOR is Matlab/Simulink based software [10] which has been developed by National Renewable Energy Laboratory (NREL) and uses the data processing elements, such as math function blocks, switches and lookup tables to simulate the HEV. There are two approaches for simulating a HEV, consisting of backward facing approach and forward facing approach [10 and 11]. In backward facing approach, the simulator assumes that powertrain components meet the required speed trace and analyzes how much each component must perform. The driver model is not required in such a model. In this approach the vehicle required force is computed in every time step to meet the speed trace. The vehicle required force passes backward through transmission components and is translated into torque and speed of the IC engine and/or EM.

In forward approach, the simulator uses a model of driver that develops throttle and brake commands, according to vehicle current speed and trace speed. The throttle commands are translated into the torque and speed of the IC engine and/or EM. The IC engine torque passes forward through transmission components and results in vehicle acceleration.

ADVISOR uses a unique backward-forward approach [10 and 11] in which the components are assumed to be ideal in the forward stream of calculations. The ADVISOR handles components

performance limitations and losses in backward stream of calculations.

Table 1 describes the main characterizations of an off-road parallel HEV, used in this study, which is modeled in ADVISOR.

3. Control Strategy

Control strategy in parallel HEV has two main objectives [12]; one is reducing fuel consumption and exhaust emissions while satisfying driver's demand. The other is to keep the battery SOC in a certain scope which guarantees the life expectancy of the battery. These issues are conflicting in nature, because the minimum fuel consumption in a spark ignition engine does not necessarily results in the minimum emissions. Hence it should be a trade of between the objectives. To meet above targets the parallel HEV adopts following strategies.

The vehicle run in pure electric mode, when the vehicle speed is below a certain value. This strategy avoids idling of the IC engine in light load condition specially in stop-start cycles i.e., heavy traffic condition.

When vehicle speed exceeds a certain value, the IC engine starts operating at fuel efficient mode.

If the driving torque is greater than IC engine optimal torque the EM starts running and traction torque is drawn from both IC engine and EM, so that the IC engine can operate at fuel efficient region.

For negative required torque (braking mode), the IC engine stops working and braking torque is distributed between mechanical braking system and regenerative braking system.

When battery SOC falls beyond minimum allowable SOC (SOC_{min}), the IC engine must drives the generator and gives a charge to the battery. If the IC engine is currently off, it should start operating at fuel efficient region; if the IC engine is already running, it should provide some extra torque to give a charge to the battery.

When driver demands the amount of torque which is greater than IC engine maximum torque and at the same time battery SOC has fallen beyond SOC_{min}, then control strategy drives the EM and uses the battery energy. Although the battery is damaged when it's in low charge state, satisfying the driver's demands is the primary target of control strategy. In addition, in a real vehicle a warning may be given to encourage driver to avoid this situation [13].

4. Fuzzy Logic Controller

Fuzzy controller is known for its ability to control complex and nonlinear systems based on human

experience. Simplicity and strong robustness of fuzzy controller make it suitable to control the HEV powertrain system. So far a lot of researches intend to apply fuzzy control method for control strategy of the parallel HEV [8, 13, and 14]. The main objective of FLC is to operate the IC engine at fuel efficient mode.

Fuel efficiency is a function of IC engine rotational speed (rpm) and engine torque (N.m). The IC engine speed depends on gear ratio and vehicle speed; so fuel efficiency can be handled by proper torque control of IC engine.

Table 1. Characterization of HEV

Vehicle	Rolling resistance coefficient	0.009
	Aerodynamic drag coefficient	0.335
	Vehicle front area	2.0 m ²
	Wheel radius	282 mm
	Glider mass	456 kg
	Cargo mass	136 kg
IC Engine	Type	Inline 4-Cylinder
	Displacement	1.0 L
	Maximum Power	25 kW
	Peak efficiency	34%
	Catalyst convertor	Standard catalyst for stoichiometric SI engine
Transmission	Gearbox	Five speed manual gearbox
	Gear Ratios	13.45, 7.57, 5.01, 3.77, 2.84
EM	Type	Permanent Magnet AC
	Maximum Power	20 kW
	Maximum speed	6000 rpm
	Peak efficiency	90%
Energy Storage System	Cell Chemistry	Lead Acid
	Number of Modules	25
	Nominal Voltage	307 V
	Energy Capacity	12 Ah
	Module Weight	4.75 kg

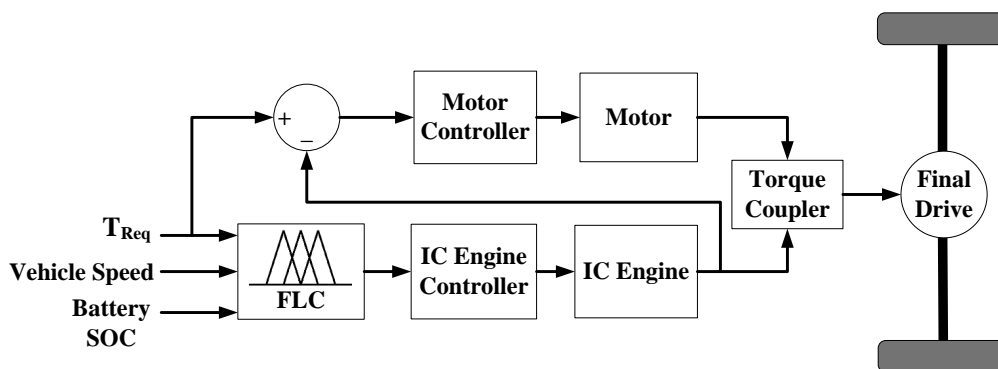

Fig1. Schematic of control strategy in the parallel HEV

The proposed FLC selects proper IC engine torque based on driver's required torque, vehicle speed and battery SOC. Since the IC engine torque is

determined by FLC; the operating torque of EM is given by:

$$T_{EM} = T_{req} - T_{Eng} \tag{1}$$

Where TEM is the EM operation torque; Treq is the driver’s required torque and TEng is the IC engine operating torque which is decided by FLC. Fig. 1 depicts the schematic of control strategy.

4.1. Design of Fuzzy Logic Controller

In this study, Mamdani type fuzzy model was adopted. The FLC receives three inputs including driver’s required torque [N.m], vehicle speed [km/h], and battery SOC. As shown in Fig. 2 (a), the required torque has seven trapezoidal MFs within the range of -5 to 150 [N.m]. A limiter is employed for Treq so that the value cannot exceed -5 and 150 [N.m]. The N-function fuzzifies negative torque values (braking mode) and the VVH-function covers the torque values that exceed powertrain maximum torque. The

powertrain maximum torque is defined as IC engine maximum torque assisted by EM maximum torque.

As shown in Fig. 2 (b), the vehicle speed consists of two MFs within the range of 0 to 60 [km/h]. A limiter is employed to saturate the upper bound of the vehicle speed to 60 [km/h].

As depicted in Fig. 2 (c), four trapezoidal MFs are used to define the battery SOC within the range of 0 to 1. The L-function is relatively narrow, because this makes the FLC sensitive when the battery SOC is near to its minimum allowable limit.

Fig. 2 shows that the FLC output consists of five MFs in the range of 0-60 [N.m]. The simplest form of MF, which is the triangular, is selected as output MFs geometry. The Zero-function denotes the engine-off mode at which the IC engine is disengaged and does not provide torque to the powertrain. The VH-function keeps the IC engine operates at the maximum torque region.

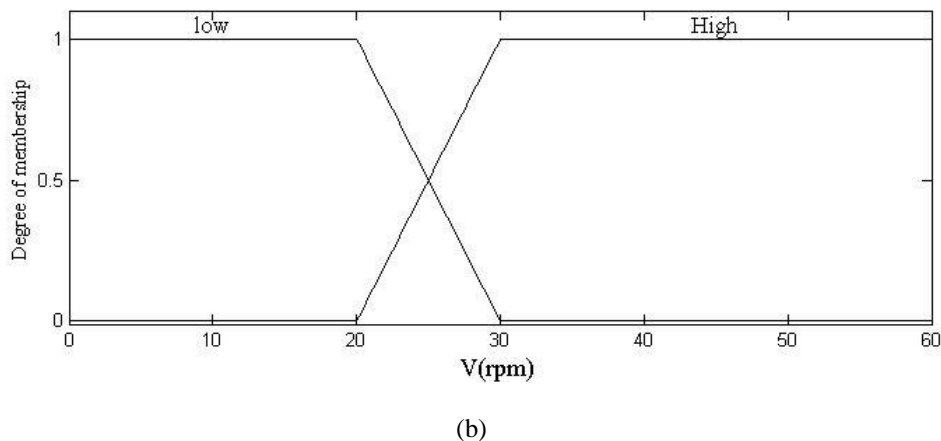
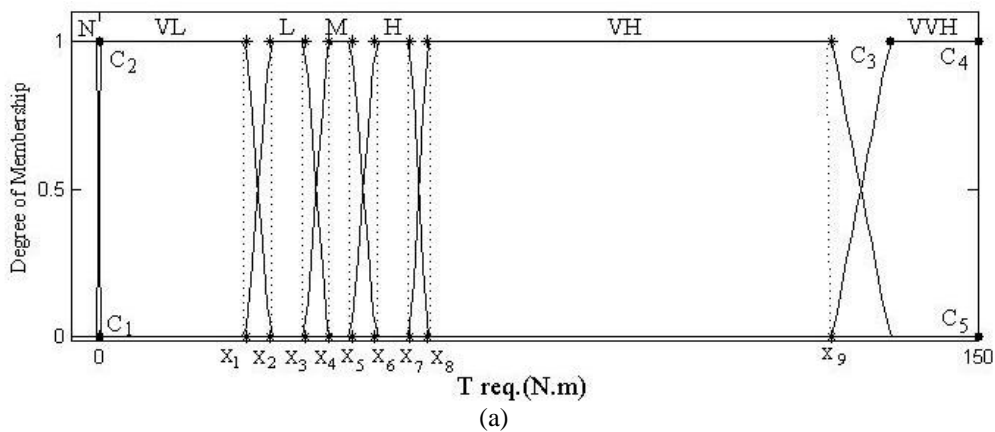

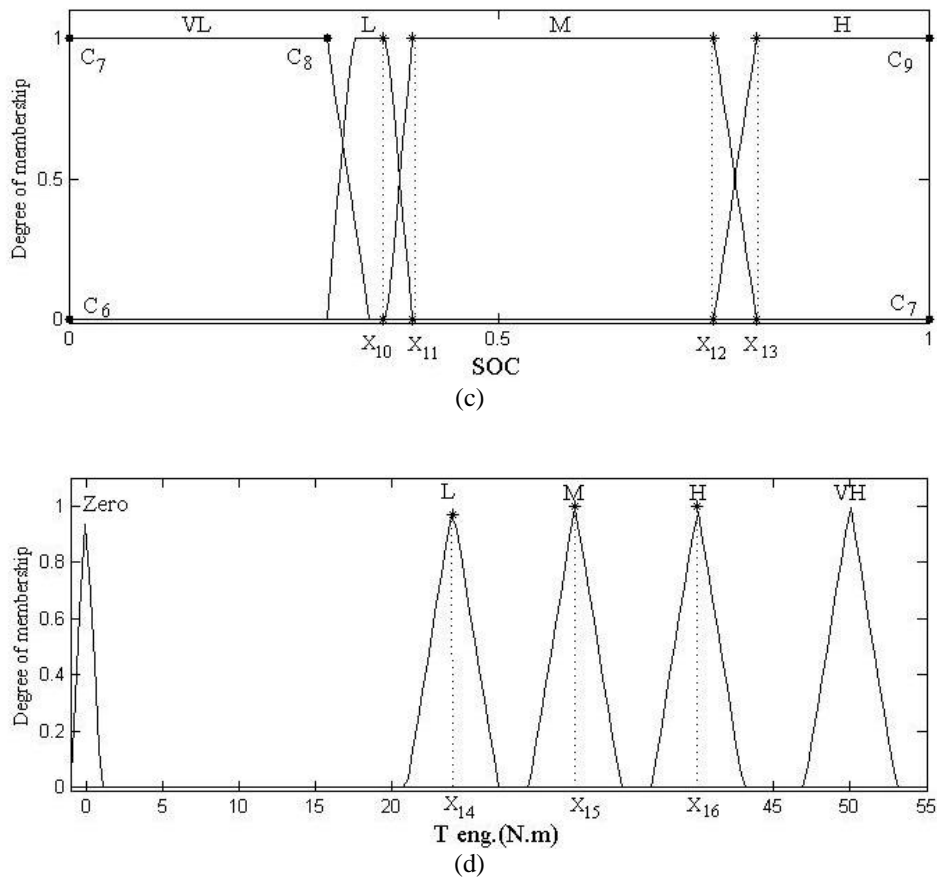

Fig2. The MFs of FLC. (a) Driver required torque. (b) Vehicle speed (c) Battery SOC. (d) Engine torque

Since the MFs were set, the rules table is defined as presented in table 2. The required torque, vehicle speed, and battery SOC have seven, two, and four MFs, respectively, therefore the rules table consists of fifty six If-then rules. The rules are set based on control strategy that was described in Section three. The following three examples illustrate the rules.

Consider a case in which the driver’s required torque is medium, vehicle speed is low and battery SOC is high. Because the charge is available at the battery and vehicle speed is low, then the vehicle is run in pure electric traction mode.

Consider another case in which the driver’s required torque is low and battery SOC is beyond SOCmin, so the IC engine operates at the most fuel efficient mode regardless of the vehicle speed. The IC engine drives the vehicle and gives a charge to the battery. In this circumstance the vehicle is run at pure engine traction mode.

When the requested torque is very high, vehicle speed is high and battery SOC is very low, then the IC engine operates at the maximum torque region and

EM provides auxiliary torque so that the driver’s demand is met.

5. Optimization of the FLC by Genetic Algorithm

The proposed FLC was designed based on human experience and doesn’t necessarily minimize the energy cost and emissions. In order to minimize the objectives, an optimization algorithm should be employed. Recently, numerous papers and applications have combined fuzzy concepts and optimization algorithms to minimize the fuel consumption and emissions. Different optimization algorithms were used in the literature to optimize the FLC parameters in the parallel HEV including differential evolutionary optimization algorithm [15], particle swarm optimization algorithm [16 and 17], and genetic algorithm optimization approach [18, 19 and 20]. In order to minimize the objectives the genetic-fuzzy algorithm is employed in this paper. The genetic-fuzzy algorithm is a FLC that its parameters are tuned by GA. The parameters set which results in most improvement in the objectives

will be introduced as optimal. This approach can be described as the off-line optimization of a real time control system. Fig. 3 depicts the schematic of genetic-fuzzy control strategy.

The GA does not require continuous and differentiable fitness function. GA is simple and robust and it does not depend on the characterization of the problem.

The performance of fuzzy controller depends on its parameters which mainly consist of MFs and rules [19]. Yang et al. [21] clustered the application of genetic-fuzzy algorithm in the following three conditions:

- Optimizing the fuzzy rules table since the MFs are known,
- Optimizing the fuzzy MFs since fuzzy rules table is known,
- Optimizing fuzzy MFs and fuzzy rules table simultaneously.

Zargham nejhada and Asaei [22] optimized a parallel HEV control strategy by tuning the rules-table of the FLC. Yang et al. [21] optimized a FLC by tuning the MFs parameters. Wang and yang [19] introduced the so-called evolutionary fuzzy design method which optimizes the fuzzy rules and MFs simultaneously by using GA. To optimize the FLC by using the GA, the rules and MFs parameters must be coded into a chromosome. Because of the great number of rules and MFs parameters, the chromosome would become too long. Increasing the chromosome length results in greater computation time. To cope with this issue, there should be a trade-off between the knowledge of expert and the number of parameters that are handled by the GA.

In this study, the rules table is set based on knowledge of expert, while MFs parameters are tuned by optimization algorithm.

Table 2. Rules table of FLC. (a) Vehicle speed is Low (b) Vehicle speed is High

		T_{req}						
		N	VL	L	M	H	VH	VVH
SOC	VL	Z	Z	Z	Z	Z	L	M
	L	Z	Z	L	M	M	H	VH
	H	L	L	M	H	VH	VH	VH
	VH	M	M	H	H	VH	VH	VH

		T_{req}						
		N	VL	L	M	H	VH	VVH
SOC	VL	Z	Z	Z	M	M	H	VH
	L	Z	Z	L	M	M	H	VH
	H	L	L	M	H	VH	VH	VH
	VH	M	M	H	H	VH	VH	VH

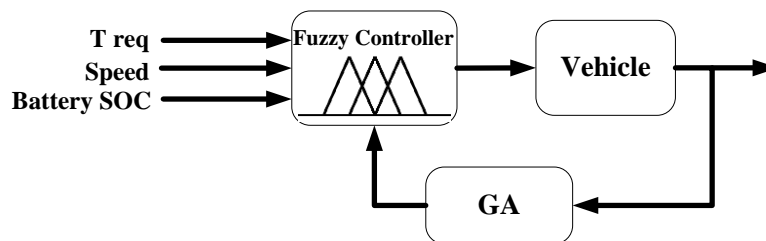

Fig3.Schematic of genetic-fuzzy control strategy

5.1. Coding the Parameters of MFs into Chromosome

When designing the genetic-fuzzy structure, one should consider an appropriate representation of parameters in the chromosome. The real number representation approach was employed to represent the parameters in the chromosome. In this method each variable in chromosome, represent a parameter in the FLC. The advantages of this approach over binary coding method lies in the conceptual simplicity and shorter length of chromosome. Another critical issue is the number of variables that should be coded. The more number of variables results in the more computation time that should be avoided. Hence some of the MFs parameters are set based on knowledge of expert and are not coded into the chromosome. These parameters mostly consist of boundary parameters of each variable. As shown in Fig. 4, in order to decrease the chromosome length, the right side of each trapezoidal is aligned to the left side of the next trapezoidal.

As shown in Fig. 2, Treq consists of seven trapezoidal MFs. Nine variables are used for coding MFs of Treq into the chromosome. The N-function fuzzifies negative range of torque (braking mode); its parameters considered as constant parameters, so they are not coded into the chromosome. The first two parameters of L-function (C1 and C2) and the last two parameters of VVL-function (C4 and C5) are boundary parameters and they are considered as constant parameters too. The C3 is located at powertrain maximum torque value; so if the required power exceeds C3, the IC engine should operates at maximum torque region. Therefore C3 location is considered as a constant parameter in order to

conserve the vehicle driving performance. The parameters of Treq are coded into the chromosome as follows:

$$X_{Treq} = (x_1, x_2, x_3, x_4, x_5, x_6, x_7, x_8, x_9) \tag{2}$$

The variables bounds of Treq are 0 and 150[N.m]. The following constraints are applied in optimization process to guarantee that the geometry shape, which is achieved by the GA, would be compatible with general concept of a trapezoidal geometry

$$x_9 > x_8 > x_7 > x_6 > x_5 > x_4 > x_3 > x_2 > x_1 \tag{3}$$

The parameters of vehicle speed depend on real world traffic condition, not the objectives, so they aren't coded into the chromosome structure and considered as constant parameters.

As shown in Fig. 2, the battery SOC consists of four trapezoidal MFs. The first two parameters of VL-function (C6, C7) and last two parameters of H-function (C9, C10) are the boundary values and are not coded into the chromosome structure. The C8 denotes the SOCmin, therefore it is considered as a constant parameter to guarantee the life expectancy of the battery. The MFs parameters of battery SOC are coded into the chromosome in a same way as Treq parameters were coded. Four variables of battery SOC are coded into a chromosome as follow:

$$X_{SOC} = (x_{10}, x_{11}, x_{12}, x_{13}) \tag{4}$$

The variables bounds of battery SOC are 0 and 1. The following linear constraints are adopted to ensure that the shape of MFs is compatible with general concept of a trapezoidal geometry

$$x_{13} > x_{12} > x_{11} > x_{10} \tag{5}$$

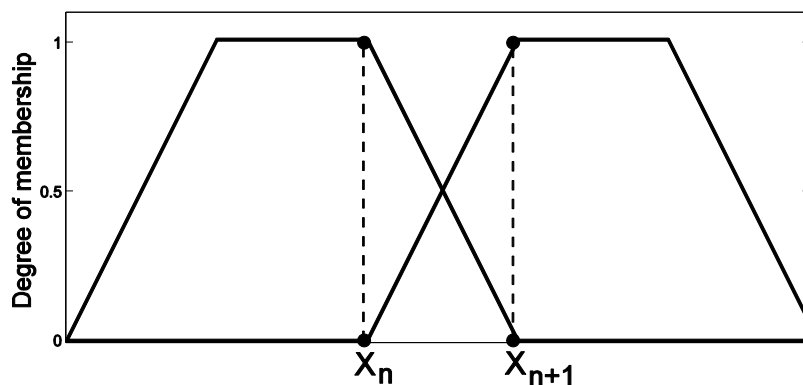

Fig4. Aligning the right side of trapezoidal to the left side of the next trapezoidal

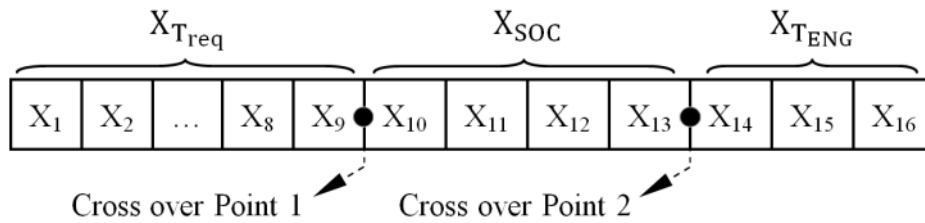

Fig5. Chromosome structure and location of cross over points

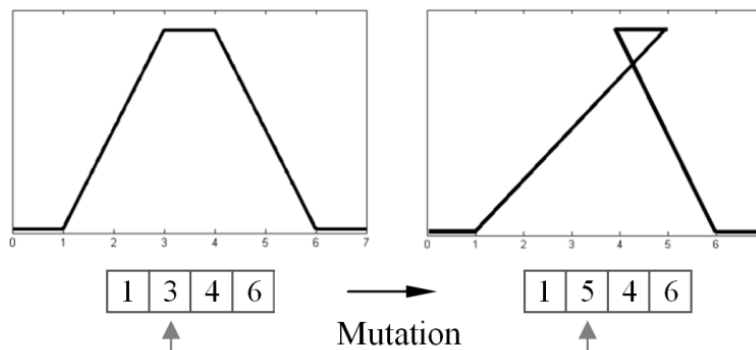

Fig6. Incompatible MFs due to mutation operation

As shown in Fig. 2, TEng is consists of five triangular MFs. Three parameters define the MFs in the chromosome. Zero-function and VH-function are responsible for the engine-off and engine maximum torque signals. By varying the Zero-function location, the possibility of engine-off mode would be emitted and by varying the VH-function location although the fuel consumption and emissions may be improved, the vehicle performance would be sacrificed. The center of triangular MFs is defined as GA variable and the width of triangular MFs is a predefined value. The parameters of TEng are coded into the chromosome as follow:

$$X_{SOC} = (x_{14}, x_{15}, x_{16}) \tag{6}$$

The variables bounds of Teng are 0 and 50[N.m] and the following linear constraints are considered to keep compatibility of the MFs with their labels

$$x_{16} > x_{15} > x_{14} \tag{7}$$

Using this approach, the dimension of solution space is included 16 variables, where, they are coded into a chromosome as shown in Fig. 5

5.2. GA operators

The GA uses three main operators, to generate the next populations which consist of selection, crossover, and mutation. The roulette wheel approach

is adopted as selection function. The one point and two point approaches are used as crossover operators. The crossover operation may result in offspring in which the linear constraints (Equations (3), (5) and (7)) are not considered. In order to keep the compatibility of the MFs geometry with linear constraints, one point and two points approaches in which the points are located at predefined places are employed. The loci of cross over points are shown in Fig. 5.

Mutation is a random change that alters the characteristic of the gene. Fig 6 shows that the mutation operator can results in incompatible MF geometry

As a solution, the parameters of an input (Treq or SOC or Teng) are multiplied by a coefficient. The coefficient is selected randomly, between an upper bound and a lower bound so that the parameters cannot exceed their range. For example the mutation coefficient for battery SOC (x_{10} , x_{11} , x_{12} , x_{13}) is selected as follow.

$$C_{SOC} = rand(LB(x_{10})/x_{10}, UB(x_{14})/x_{14}) \tag{8}$$

where CSOC is the coefficient of battery SOC, LB(x_{10}) is lower bound of x_{10} (C3 point) and UB(x_{14}) is upper bound of x_{14} (C4 point).

5.3. Fitness Function

Fitness function evaluates the fitness of each string in the population. It has a great influence on the GA optimization results. In previous research papers the optimization goal was defined as the minimization of fuel consumption and emissions. Hence the variance of battery SOC was kept constant so that the battery energy expenditure can be neglected and the vehicle could achieve total driving energy by consuming the fuel. In Yang et al. [21] and Zargham nejhad and Asaei [22], in order to eliminate the influence of battery energy on fuel consumption, the authors found a special amount of battery initial SOC. Using this amount of initial SOC, the variation between initial SOC and final SOC became negligible. Poursamad and Montazeri [18] and Yi [20] considered the variance between initial SOC and final SOC, in penalty function to minimize the variation of battery SOC.

In general, the variance between initial SOC and final SOC is not necessarily negligible. The battery may be depleted or may be charged during driving cycle. This is why this paper employed energy cost factor instead of fuel consumption factor. Energy cost is a function of fuel consumption and variation of battery SOC. In order to unify two variables into a factor, the economic cost for each source is taken into account. Simulation result shows when the battery is fully depleted (SOC=0), it consumes 4.2 kWh to become fully charged (SOC=1); In this simulation, the battery losses are taken into account. The average energy price in 2012 is 3.2 USD per a gallon of gasoline and 11.3 Cents per kWh of electricity; therefore the battery costs 47 Cents to be fully charged. So the energy cost factor is achieved as follow:

$$EC = 3.2 \times FC + 0.47 \times \Delta SOC \tag{9}$$

where EC is energy cost factor [USD]. FC is fuel consumption (gallon) and ΔSOC is the variation between initial SOC and final SOC.

As shown in (10), the integral of energy cost and emissions over the whole cycle are considered as fitness function

$$Obj(x) = w_1 \cdot \int_0^{T_{DC}} EC + w_2 \cdot \int_0^{T_{DC}} Emiss + w_3 \cdot P \tag{10}$$

where $obj(x)$ is the fitness value of string x , T_{DC} entire drive cycle time, and w_1 , w_2 , and w_3 target weights which are determined based on trial and error. The $Emiss$ represents weighted sum of emissions. $Emiss$ is calculated from

$$Emiss = \frac{NO_x + CO/5 + hc}{3} \tag{11}$$

where NO_x , CO , and HC are polluting emissions [g/km].

P represents the penalty function which consists of driving performance constraints. The penalty function guarantees that the driving performance will not be sacrificed. The penalty function is determined as:

$$P = \int_0^{T_{DC}} Miss - trace \tag{12}$$

Where $Miss-trace$ is the difference between actual speed and cycle required speed since exceeds 1 [km/h].

6. SIMULATION RESULTS

In the simulation, GA parameters are selected as follows: both population size and maximum number of generations parameters are equal 50. The crossover and mutation rates are selected as 0.8 and 0.3, respectively. Fig. 7 depicts the convergence curve of objective function (the best fitness value in the population vs. generation) for UDSS cycle..

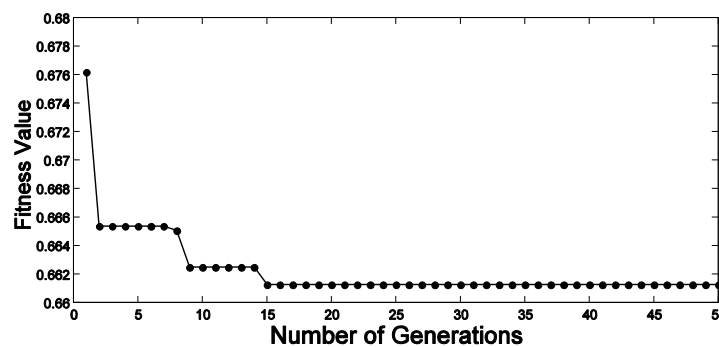

Fig7. Convergence curve of objective function over UDSS cycle

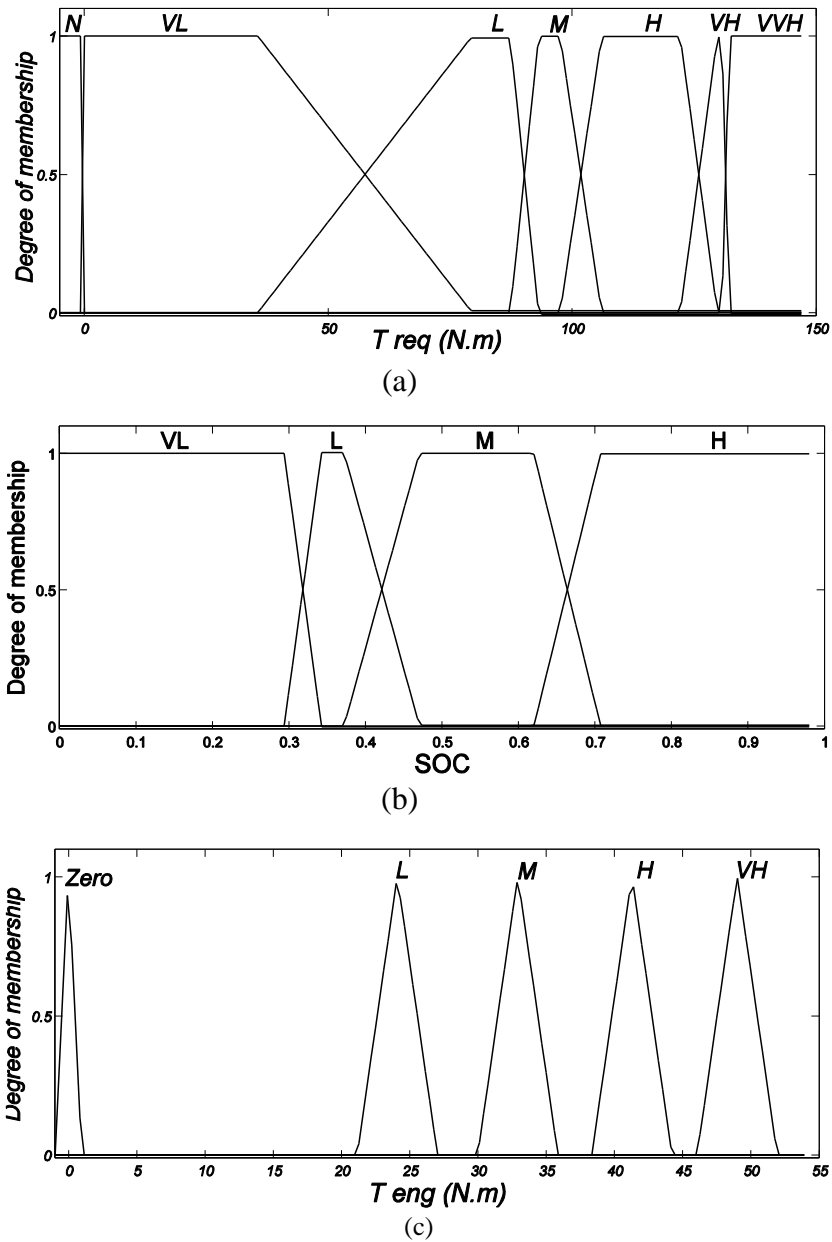

Fig8. Optimized MFs over UDDS cycle. (a) Driver required torque. (b) Battery SOC. (c) Engine torque

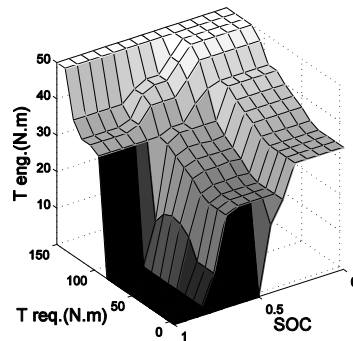

Fig9. Optimized fuzzy control surface for UDDS

Table 3. Comparison of fuel, and battery usage, and emissions of three strategies over UDDS cycle.

Control strategy	Fuel consumption (L/100km)	Δ SOC (%)	Pollution (grams/km)
ADVISOR Built-in	5.0	7.3	NO _x : 0.21 CO: 1.53 HC: 0.24
Fuzzy	4.2	3.8	NO _x : 0.25 CO: 1.05 HC: 0.24
Genetic-Fuzzy	3.7	9.4	NO _x : 0.18 CO: 0.81 HC: 0.20

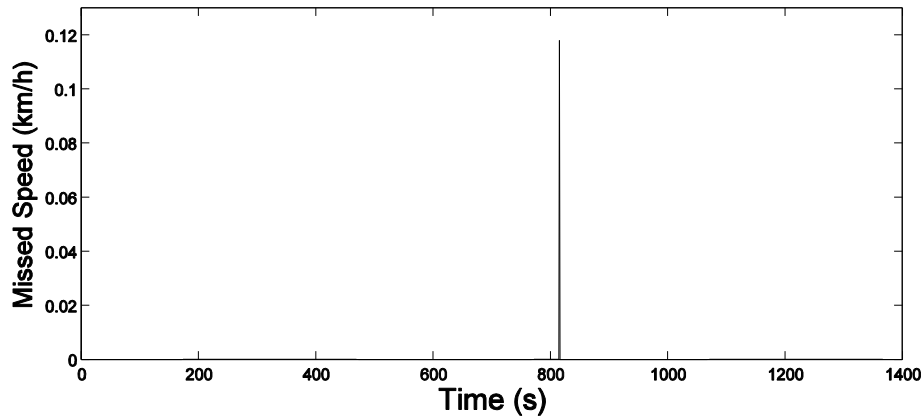

Fig10. Missed speed of the HEV over UDDS cycle

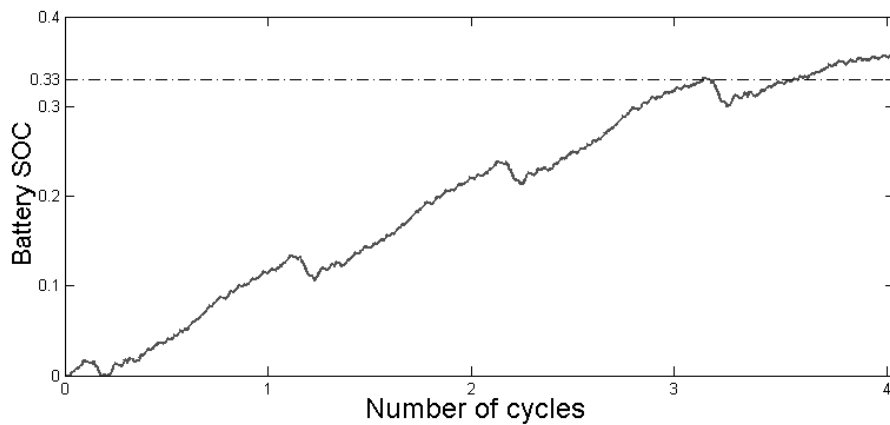

Fig11. Variation of battery SOC during 4 UDDS cycles

The table compares the effectiveness of human experience and the global solution in reduction of fuel and battery usage, and emissions. Compare to initial FLC, the tuned FLC results in significant reduction of fuel, and battery usage, and emissions. Fig. 10 depicts the missed speed over UDDS cycle. As can be seen, the missed speed does not exceed 1 [km/h], so the

driver request is satisfied in optimized FLC. As aforementioned, the control strategy has to keep the battery SOC within a certain scope to guarantee the life expectancy of the battery. Fig.11 depicts the variations of battery SOC when the battery is fully depleted (SOC=0) at initial condition. The battery

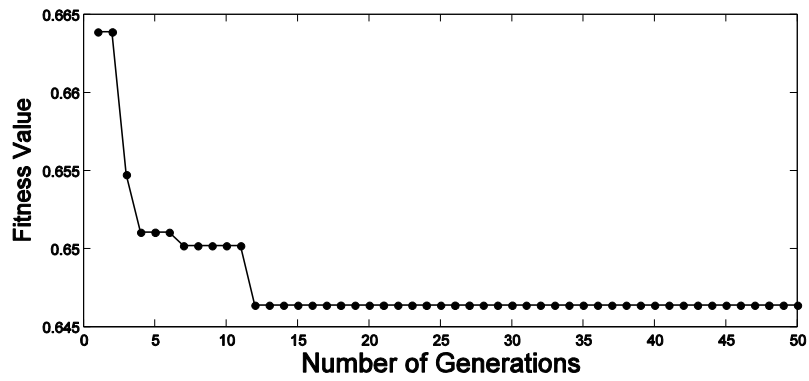

Fig12. Convergence curve of objective function over NEDC cycle

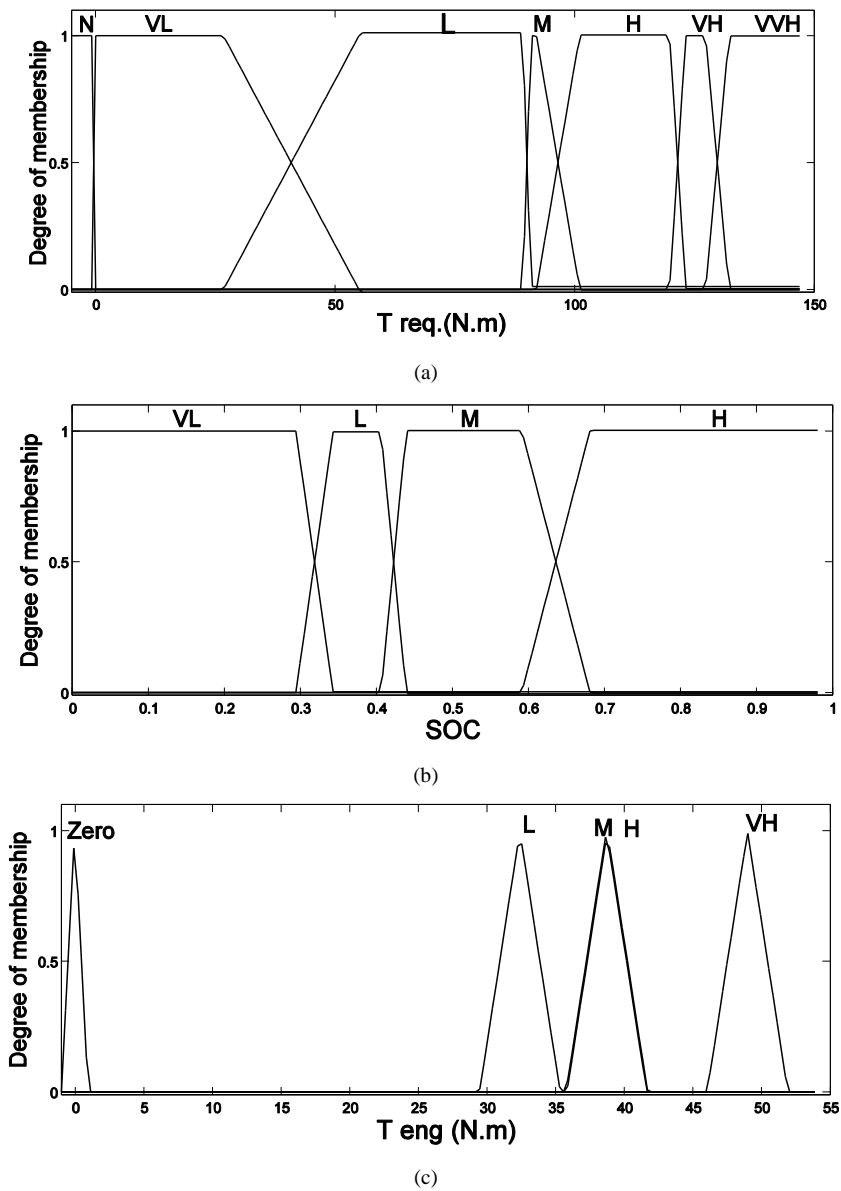

Fig13. Optimized MFs over NEDC cycle. (a) Driver required torque. (b) Battery SOC. (c) Engine torque

Table 4. Comparison of fuel, and battery usage, and emissions of three strategies over NEDC cycle

Control strategy	Fuel consumption (L/100km)	Δ SOC (%)	Pollution (grams/km)
ADVISOR Built-in	5.0	7.5	NO _x : 0.19 CO: 1.53 HC: 0.25
Fuzzy	4.3	5.0	NO _x : 0.25 CO: .99 HC: 0.27
Genetic-Fuzzy	3.8	9.5	NO _x : 0.18 CO: 0.97 HC: 0.22

SOC reaches minimum allowable SOC (SOC=0.35) over three UDDS cycles.

To study the impact of driving cycle on the proposed genetic-fuzzy control strategy, the FLC is also optimized over NEDC driving cycle. The NEDC is new European driving cycle which is used for light vehicles. Fig 12 shows the convergence curve of objective function for NEDC cycle. The optimized MFs over NEDC cycle are depicted in Fig. 13. Fuel, and battery usage, and emissions of the vehicle over NEDC cycle using ADVISOR built-in control strategy, initial FLC, and tuned FLC are presented in Table 4.

7. Conclusion

A fuzzy logic control strategy for parallel HEV was proposed to manage the powertrain system. The fuzzy rules table was designed based on knowledge of expert, while parameters of fuzzy MFs were optimized by adopting GA. The goal of optimization was to minimize energy cost and emissions. In order to consider the energy consumption of the battery, the variance between initial SOC and final SOC of the battery considered in objective function. The controller parameters were optimized over UDDS and NEDC drive cycles. This approach improved the energy cost about 16%, and also reduced the emissions by 32%, since the vehicle performance didn't sacrifice. The tuned FLC also kept the battery SOC within a suitable range, and IC engine operated at fuel efficient region. The proposed genetic-fuzzy approach is a robust approach which has potential to be used in the control unit of a real vehicle.

REFERENCES

- [1]. L. Majdi, A. Ghaffari, N. Fatehi, (2009) "Control strategy in hybrid electric vehicle using fuzzy logic controller" IEEE International Conference on Robotics and Biomimetics. 842-847
- [2]. B. M. Baumann, G. Washington, B. C. Glenn, and G. Rizzoni, (2000) "Mechatronic design and control of hybrid electric vehicles," IEEE/ASME Transl. j. Mechatronics. 5, 58-72.
- [3]. S. Onoda, A. Emadi, (2004) "PSIM-based modeling of automotive power systems: conventional, electric, and hybrid electric vehicles," IEEE Transaction on vehicular technology. 53, 390-400
- [4]. M. Montazeri-Gh, M. Asadi, (2008) "Genetic-fuzzy shifting strategy for continuously variable transmission in parallel HEV" Proceeding of the 5th International Symposium on Mechatronics and its Applications, 1-6
- [5]. M. Sorrentinon, G. Rizzo, I. Arsie, (2011) "Analysis of a rule-based control strategy for on-board energy management of series hybrid vehicles" control strategy practice. 1433-1441
- [6]. H. Hannoun, D. Diallo, (2006) "Energy management strategy for a parallel hybrid electric vehicle using fuzzy logic" Int. Symp. on Power Electronics, Electrical Drives, Automation and Motion, 36-41
- [7]. F. U. Syed, D. Filev, and H. Ying, (2007) "Fuzzy rule-based driver advisory system for fuel economy improvement in a hybrid electric vehicle" Annu. Conf. NAFIPS, 178-183

- [8]. B. J. Zhang, Y. W. Deng, and D. J. Yu, (2008) "An investigation on energy management system of CJY6470 parallel hybrid electric off-road vehicle with fuzzy logic" IEEE VPPC, pp. 1-9
- [9]. D. Yuanwang W. Yaonan C. Jieping, (2005) "A study on the distributed energy of the CFA6470 hybrid electric vehicle based on the method of the MATLAB" International conference on Electrical Machines and Systems (ICEMS), 853 – 856
- [10]. K. B. Wipke, M. R. Cuddy, S. D. Burch, (1999) "ADVISOR 2.1: a user-friendly advanced powertrain simulation using a combined backward/forward approach" IEEE Trans. J. Vehicular Technology. 1751-1761
- [11]. T. Markel et.al (2002) "ADVISOR: a systems analysis tool for advanced vehicle modeling" J. Power Sources. 110, 255-266
- [12]. G. Shi, Y. Jing, A. Xu, J. Ma, (2006) "Study and simulation of based-fuzzy-logic parallel hybrid electric vehicles control strategy" IEEE Proceedings of the Sixth International Conference on Intelligent Systems Design and Applications, 280-284
- [13]. S. G. Li, S. M. Sharkh, F. C. Wa lsh, and C. N. Zhang, (2011) "Energy and battery management of a plug-in series hybrid electric vehicle using fuzzy logic" IEEE Trans. J. Vehicular Tecnology, 3571-3585
- [14]. A. Wang, W. Yang, (2006) "Design of energy management strategy in hybrid electric vehicles by evolutionary fuzzy system part I: fuzzy logic controller development," Proceedings of world congress on intelligent control and automation, 8324-8328
- [15]. L. Wu, Y. Wang, X. Yuan, Z. Chen, (2011) "Multiobjective optimization of HEV fuel economy and emissions using the self-adaptive differential evolution algorithm" IEEE Transactions on vehicular technology, 2458-2470
- [16]. M. Zhou, H. Zhang, X Wang, (2011) "Research on fuzzy energy management strategy of parallel hybrid electric vehicle" IEEE International Conference on Electronic & Mechanical Engineering and Information Technology, 967-971
- [17]. X. Wu, B. Cao, J. Wen, Y. Bian, (2008) "Particle swarm optimization for plug-in hybrid electric vehicle control strategy parameter" IEEE Vehicle Power and Propulsion Conference (VPPC),1-5
- [18]. A. Poursamad, M. Montazeri, (2008) "Design of genetic-fuzzy control strategy for parallel hybrid electric vehicles" Control engineering practice, 861-873
- [19]. A. Wang, W. Yang, (2006) "Design of energy management strategy in hybrid electric vehicles by evolutionary fuzzy system part II: tuning fuzzy controller by genetic algorithms" Proceedings of world congress on intelligent control and automation, 8329-8333
- [20]. T. Yi, Z. Xin, Z. Liang, (2009) "Fuzzy-genetic control strategy of hybrid electric vehicle," International Conference on Intelligent Computation Technology and Automation, 720-723
- [21]. S. Yang, M. Li, B. Xu, B. Guo, C. Zhu, (2010) "Optimization of fuzzy controller based on genetic algorithm" IEEE International conference on intelligent system design and engineering application, 21-28
- [22]. A. Zargham nejhada, and B. Asaei, (2010) "A fuzzy-genetic algorithm approach for finding a new HEV control strategy idea" PEDSTC, 224-22