

Application of long-short pile retaining system in braced excavation

Changjie XU^{1,*}, Yuanlei XU², Honglei SUN³

Received: November 2013, Revised: December 2014, Accepted: March 2015

Abstract

In soft soil areas, equal-length piles are often adopted in the retaining system. A decrease in the bending moment value borne by the retaining structure along the pile depth (below the excavation bottom), leads to an inadequate use of the pile bending capacity near the pile bottom. This paper presents retaining systems with long and short pile combinations, in which the long piles ensure integral stability of the excavation while the short piles give full play to bearing the bending moment. For further analysis on pile and bottom heaves deformations and inner-force characteristics, three-dimensional models were built in order to simulate the stage construction of the excavation. The ratio between long and short pile numbers, and the effects on short pile length pile horizontal deformation, pile bending moment and bottom heave are investigated in detail. In the end, a feasible long-short pile combination is established. Obtained results from the simulation data and the field data prove that the long-short pile retaining system is feasible.

Keywords: Long-short piles, Soft soil, Excavation, Retaining strutting system, FEM simulation.

1. Introduction

Excavation is an important part of foundation engineering. Many retaining methods have developed according to different excavation conditions, such as diaphragm wall, soil nailing retaining wall, and piles with brace [1]. Among them, diaphragm wall method has good integrity and security, which can be applied to various kinds of excavations, while the high cost and long construction period prevent it from being used in general excavations. Soil nailing retaining wall can only be used in shallow excavations and areas with good soil properties. Piles with brace system is widely used in urban area with soft soil due to its well control of excavation-caused displacement, and as a result, the excavation influence on adjacent buildings or subways is acceptable.

While, Soil nailing system is not good at taking the excavation-caused deformation under control, but it is much more economic and faster constructed compared with pile brace system, and therefore it is more appropriate to excavation with open fields.

At present, a large number of scholars have presented extensive investigation into the performance of piles with

brace system including the deformation, inner-force, stability, pile-soil interaction, embedded ratio. Zhou et al. [2] established a mathematical model of optimum design for the joint point and gave the analytical solutions of the model based on analyses of the mechanical characteristics of pile with brace. Hong et al. [3] simulated the excavation process and studied the pile-soil interaction in soldier-piled excavations via data comparisons between different simulation methods with two and three dimensional models. Took the excavation of Nanshijie station in Suzhou subway as an example, Gao et al. [4] investigated the effects of pile embedded-depth ratio on the excavation deformation and pile inner-force with the help of deep excavation design software.

However, all the above-mentioned studies focused on the equal-length pile, i.e. the lengths of all the retaining piles are the same. According to Leung et al. [5], equal-length pile design (the length of all piles are equal and calculated considering the most dangerous condition in which maximum internal force comes into being) doesn't make full use of the soil, because the maximum internal force of the lower part of the pile is about one-fourth to the upper part. If equal – length pile method is adopted, strength of materials of the lower part of the pile can't be full used. Long-short pile method as a new design idea, possesses promising development prospects due to its reliability and economy and has been applied in ground improvement and foundation engineering [6]. Wu et al. [7] obtained the load-settlement relation of long-short pile, and deduced the analytical formulas for complex modulus and the pile-soil stress ratio of long-short pile foundations. Li et al. [8] conducted 11 groups of model experiment in

* Corresponding author: xucj@zju.edu.cn

¹ PhD, Professor, School of Civil Engineering and Architecture, East China Jiaotong University, Nanchang, Jiangxi, 330013, China

² Junior engineer, Zhejiang Academy of Building Research & Design Co. Ltd., Hangzhou, 310058, China

³ PhD, Associate professor, College of Civil Engineering and Architecture, Zhejiang University, Hangzhou, 310058, China

sand soil to analyze the strain and the displacement of the piles, drawing the conclusion that the horizontal displacements of long and short piles were similar and the long ones undertook more bending moment. Zheng et al. [9] carried out model experiment to study the top displacement and the bending moment of piles during the excavation process, clarifying the interaction between long piles and short piles.

These researches on the long-short pile retaining system are still in the stage of laboratory experiment, and its in-situ working mechanism need to be further investigated. Currently, there is no unified Technical Code for the long-short pile retaining system design, which greatly restrains its popularization and application in the engineering practice. In the present paper, a three dimensional finite element model for the long-short pile retaining system was established and the calculation method of long-short pile system was provided. The effects of different long-short pile length combinations and long-short pile number ratios were studied in detail. At the end, the simulation results with field data comparisons proved the feasibility of long-short pile method, which can be used as reference in similar practice.

2. Calculation Rules on Long-Short Pile System

2.1. Length determination of long pile and short pile

The length of long pile is determined by the integral stability, which can be calculated through equal-length pile calculation method. The length of short pile is determined by maximum bottom heave allowed. As stated in Faheem et al. [10] and Wang et al. [11], the embedded depth has obvious effects on bottom heave in the process of excavation; retaining piles stopped the lateral deformation of the soil towards the excavation, thus, the longer embedded depth would result in smaller bottom heave. When long-short pile system was adopted, the bottom heave would increase as the lengths of some piles are shortened.

Bottom heave stability coefficient F_s was calculated by Formula (1), as given in Zhang et al. [12]:

$$F_s = \frac{N_c c_{ub} + \gamma_2 D + \frac{2\alpha c_{udp} D(1 + \frac{B}{L})}{B}}{\gamma_1 (H + D) + q} \quad (1)$$

where H is the excavation depth, D is the embedded depth, B is the excavation width, L is the excavation length; N_c is the stability factor,

$$N_c = \begin{cases} 5(1+0.2B/L)(1+0.2(H+D)/B), & \text{for } (H+D)/B < 2 \\ 7.5(1+0.2B/L), & \text{for } (H+D)/B > 2.5 \end{cases} \quad (2)$$

c_{ub} is the average cohesion value of disturbed soil areas below the excavation bottom (kPa); c_{udp} is the average cohesion value of passive soil along the depth of pile (kPa); γ_1 is the average unit weight of natural soil layers from ground to the toe of the pile outside the excavation (kN/m³); γ_2 is the average unit weight of natural soil layers from excavation surface to the bottom of the pile (kN/m³); α is the cohesive correction coefficient between piles and soil, which is less than 1 and could be adopted from 0.2~0.7; q is the ground overload (kPa).

In Technical Specification for Retaining and Protection of Building Foundation Excavations [13], the allowable bottom heave stability coefficient is 1.6. The length of short pile can be determined with Formula (1). Meanwhile, Technical Code for Monitoring of Building Foundation Pit Engineering [14] gives the maximum bottom heave allowed, thus the bottom heave caused by shortening pile length shall also be checked with this limit value.

2.2. Ratio between number of long pile and number of short pile

After the shortening of some piles, part of the bending moment previously borne by these piles is then passed on to the long piles nearby, which will result in an increase of the bending moment of long pile. Therefore, the number ratio between long pile and short pile is determined by the bending moment capacity of long pile.

3. Three-Dimensional Simulations

3.1. General descriptions

The excavation used for analyses was approximately 72 m by 36 m in plan, with an excavation depth of 11.9 m. The layout of excavation and parts of monitoring points are shown in Fig. 1. The excavation was supported by 900 mm diameter bored piles spacing at 1.2 m combined with two levels of steel struts at 0.9 m and 6.6 m the below ground surface, respectively. The elastic module of the piles was 3×10^4 MPa and that of strut was 5×10^4 MPa. The horizontal displacement of the FE Model is restrained at the left and right boundaries, and the vertical and horizontal displacements of the FE Model are restrained at the bottom. To consider the process of excavation, staged construction with different load types was simulated.

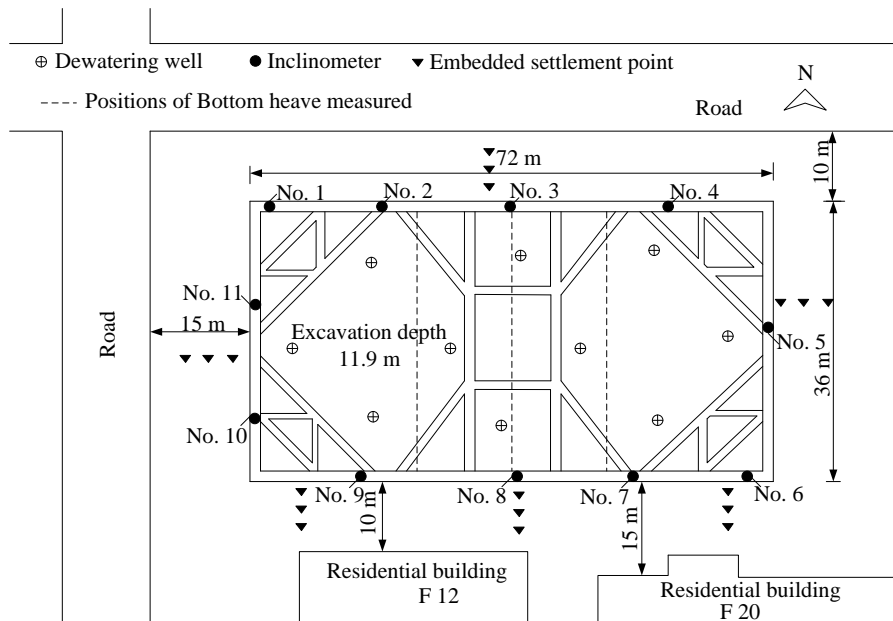

Fig. 1 Layout of the excavation

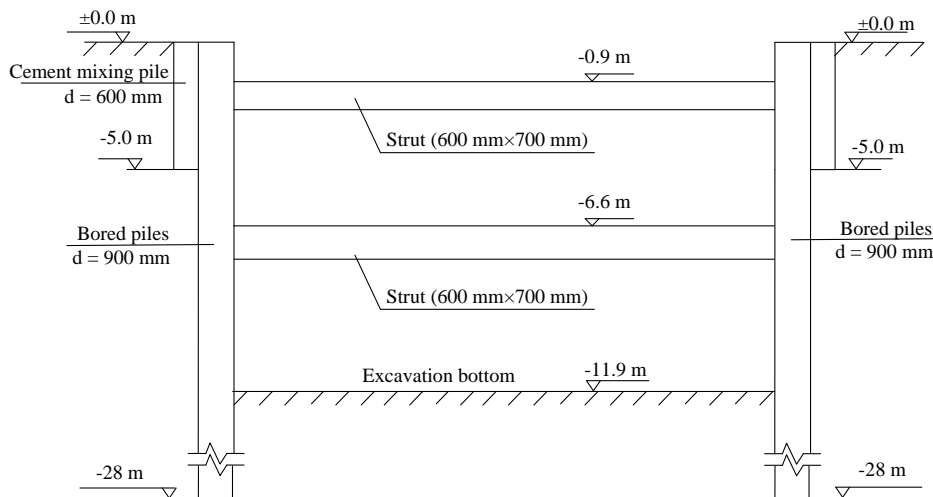

Fig. 2 Typical section of the excavation

The model parameters used are described in detail in Table 1.

Table 1 Soil properties at the construction site

Soil layers	Thickness /m	Unit weight $\gamma/kN/m^3$	Elasticity Modulus E/MPa	Poisson's ratio ν	Cohesion c/kPa	Internal friction angle $\phi/^\circ$	Dilatation angle $\psi/^\circ$
Sandy silt	2.4	18.7	5.83	0.31	29.4	12.5	0.0
Mucky silty clay	6.0	17.3	2.68	0.35	12.8	8.7	2.0
Mucky silty clay	17.6	17.4	2.85	0.33	15.1	11.9	0.0
Sandy silt	9.0	19.3	7.00	0.27	41.6	18.9	1.0

The long pile length was calculated from equal-length method. Due to the symmetry of the excavation, semi-plane was adopted. The pile length was 28 m. The bending moment envelop is shown in Fig. 3. The dotted line indicated the design capacity of the piles as 682 kN·m/m, which was approximately 1.2 times of the maximum

bending moment. The maximum bending moment appeared near the excavation bottom, and then the value decreased sharply along the pile depth. At the depth of 24 m, the bending moment was 1/5 of the maximum, and part of the pile can be shortened. According to 2 Calculation rules on long-short pile system, in this case the short pile

length was about 24 m, and the proportion of short pile number was 3/4 around.

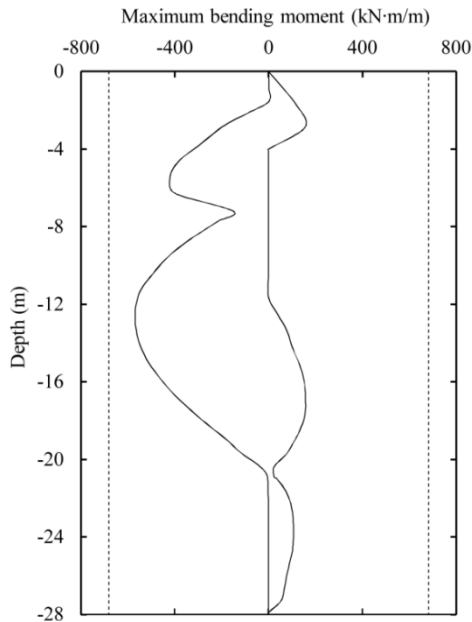

Fig. 3 Bending moment envelope of the piles

The performance of long-short pile system was investigated in the following two aspects: (i) the effects of short pile lengths (28m, 26 m, 24 m and 22 m) on the retaining structure inner-force, deformation and bottom heave. (ii) the effects of long and short pile number ratio (1:0, 1:1, 1:2 and 1:3) on retaining structure inner-force, deformation and bottom heave.

3.2. Details about software and modeling

The simulation of long-short pile retaining system cannot be achieved by two dimensional models. In this paper, PLAXIS 3D FOUNDATION was adopted for calculation. PLAXIS 3D FOUNDATION is a three-dimensional finite element program especially developed for the analysis of foundation structures. It uses a convenient graphical user interface that enables users to quickly generate a true three-dimensional finite element mesh based on a composition of horizontal cross sections at different vertical levels. PLAXIS 3D FOUNDATION offers three dimensional finite element calculations in which proper models are incorporated to simulate soil behavior and soil-structure interaction. The soil is simulated by Hardening soil (HS) model. The HS model allows the plastic compaction (cap hardening) as well as plastic shearing of the soil due to deviatoric loading (friction hardening). This model can be used to simulate the behavior of gravel, sand, and soft soils, such as clay and silt [15]. The application of this model to engineering is also extensive; including bearing capacity of ground, dam filling, slope stability analysis, and excavation [16, 17]. The 15-node wedge element, pile element, and beam element are used to simulate the soil, retaining piles, and strut, respectively. The connection of piles to soil is used as software default.

3.3. Results analysis

3.3.1. Effects of short pile length

Four groups of piles with one long pile (28 m) and one short pile with various lengths were investigated:

Group 1: equal-length pile. The lengths of long and short pile were all chosen as 28 m. Take this group as reference group.

Group 2: one long pile and one short pile with the length of 26 m.

Group 3: one long pile and one short pile with the length of 24 m. The retaining strutting system of FEM model is shown in Fig. 4.

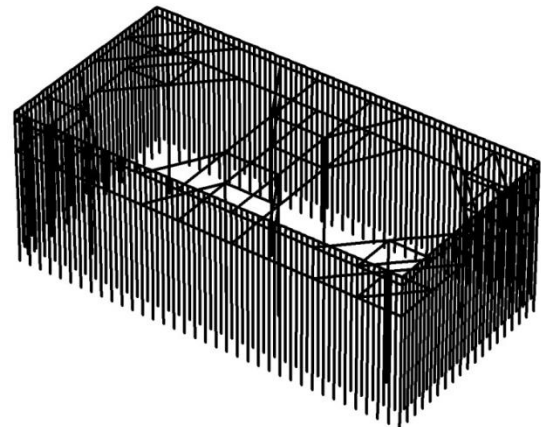

Fig. 4 Three-dimensional calculation model of group 2 (28 m and 24 m)

Group 4: one long pile and one short pile with the length of 22 m.

In FEM simulation, we selected two pile positions respectively for analysis: (i) along the long direction of the excavation, the long pile in the middle; (ii) along the long direction of the excavation, the short pile right next to the long pile. The results of the simulation are presented reflecting the last stage of excavation: excavated to the bottom.

The bending moment curves of piles under various pile lengths are shown in Fig. 5. The bending moment shows minor difference above the excavation bottom. The positions of maximum value are near the excavation bottom. The bending moment of long piles is larger than that of short piles, which is consistent with the experimental results of Zhu et al. [8]. Comparison between the 4 groups reveals that short pile with smaller length leads to larger bending moment in the long piles. When the short pile changes from 28 m to 22 m, the maximum bending moment of long pile increases from 560 kN·m/m to 852 kN·m/m. The curves differ obviously near the bottom part of the long pile, revealing that the bending moment borne by the shortened piles is passed on to the long pile nearby. In Group 4, as the short pile is not long enough, the bending moment of long pile (852 kN·m/m) is 25% more than the design capacity (682 kN·m/m), which is not allowed in practice. For the short piles, the curves of various pile lengths don't show large discrepancy. The bending moment near the pile bottom has a small tendency to decrease.

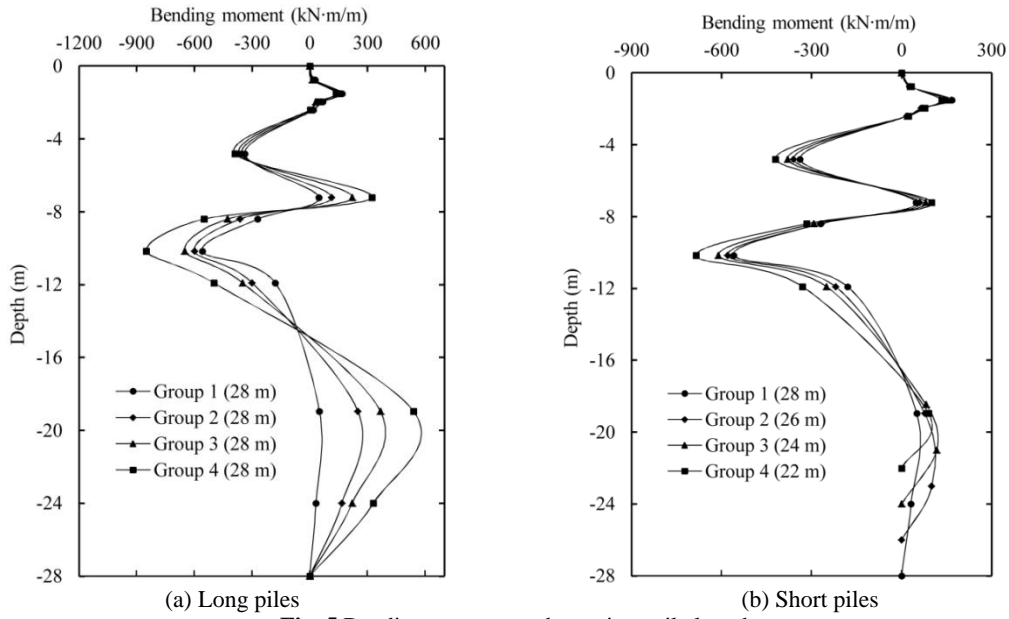

Fig. 5 Bending moment under various pile lengths

The horizontal displacement curves of piles under various pile lengths are shown in Fig. 6. The maximum displacements of both long and short piles occur at the positions near the excavation bottom. Within two times of the excavation depth, the horizontal displacements of long and short piles are similar. The length shortening of some piles lead to the increase of displacement near the bottom,

and the bottom displacement of short piles is larger than that of long piles. From Group 2 to Group 3, the maximum displacement increases by 5 mm, while in Group 4, as a result of insufficient embedded depth, the long pile bottom displacement is 31 mm and that of short pile is 62 mm. Due to its serious pile deformation, Group 4 should not be adopted in practice.

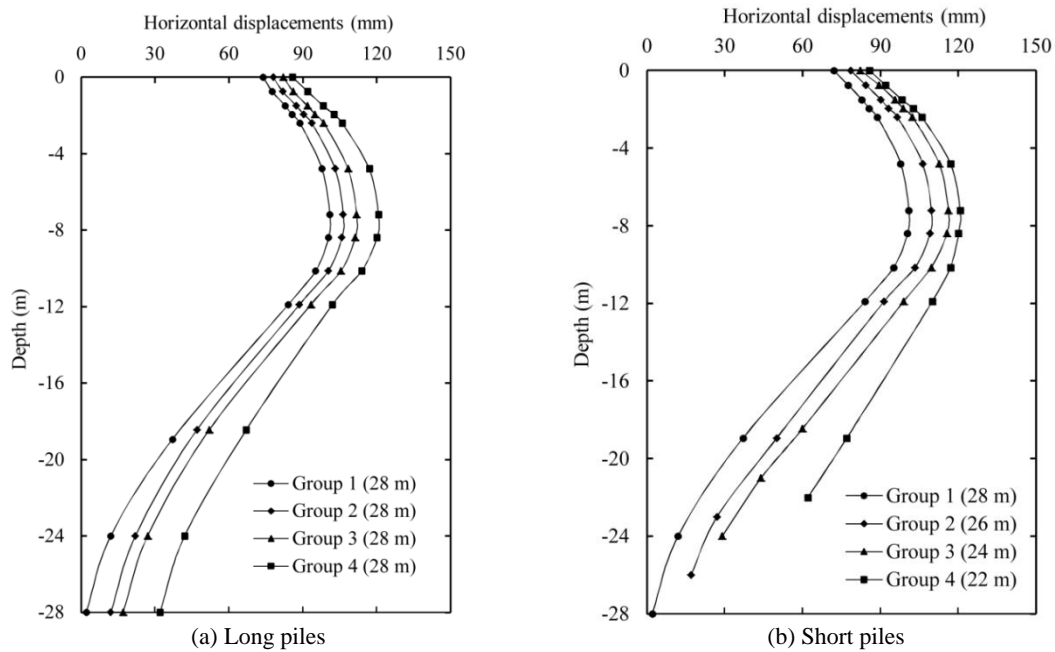

Fig. 6 Horizontal displacement under various pile lengths

The bottom heave curves under various pile lengths are shown in Fig. 7. When the short pile length decreases from 28 m to 22 m, the bottom heaves increase obviously. From Group 1 to Group 3, the effects on heaves near the excavation edge are larger than that in the excavation

center. According to *Technical Specification for Retaining and Protection of Building Foundation Excavations* [13], the maximum bottom heave allowed is 50 mm. The center heave of Group 4 exceeds the heave allowed and cannot be used in practice.

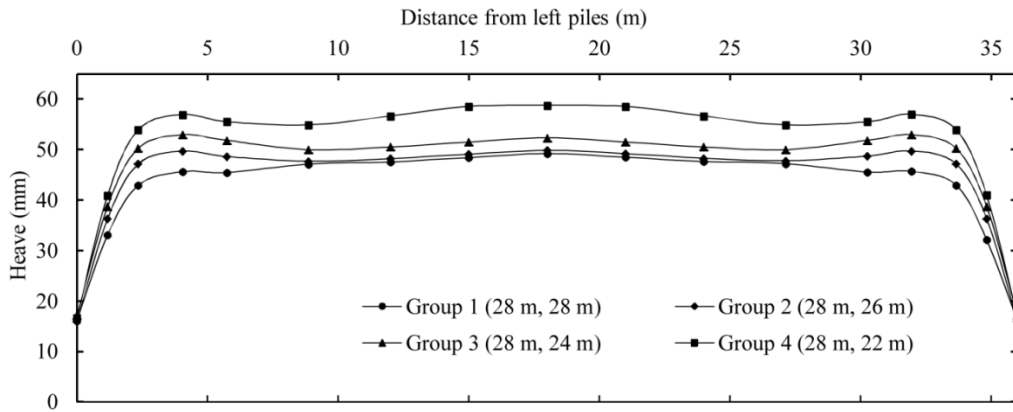

Fig. 7 Bottom heave under various pile lengths

Compared with isometric pile in Group 1, the results of Group 2 and Group 3 are within the acceptable range, while Group 4 is not acceptable. The simulation results show minor difference between Group 2 and Group 3. Considering that Group 3 is more economical, Group 3 is selected in the project.

3.3.2. Effects of ratio between long pile and short pile

On basis of 3.2.1 Effects of short pile length, 28 m long pile and 24 m short pile group is selected for further study of effects of ratio between long pile and short pile.

Group 1: short pile number: long pile number= 1:0, i.e. equal-length pile with pile length 28 m. Take this group as

reference group.

Group 2: short pile number: long pile number= 1:1.

Group 3: short pile number: long pile number= 1:2.

Group 4: short pile number: long pile number= 1:3.

The bending moment curves of piles with various long-short pile ratios are shown in Fig. 8. As the number of short pile increases, the bending moment of both long pile and short pile increase. The maximum bending moment increase of Group 2 and Group 3 is within 30%, while the maximum bending moment of Group 4 (903 kN·m/m) is 1.3 times of the design value (682 kN·m/m). In general, the bending moment of long pile is larger than that of short pile.

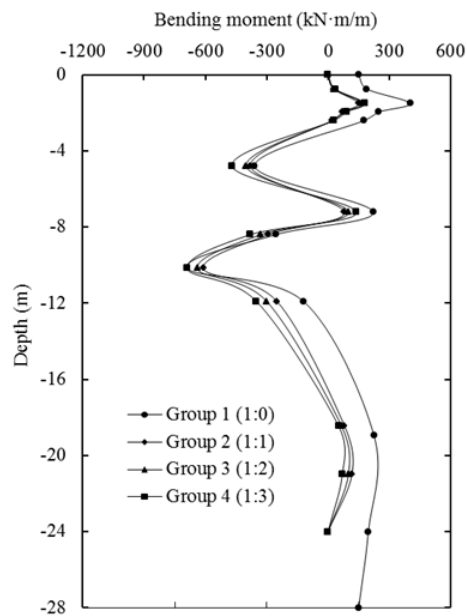
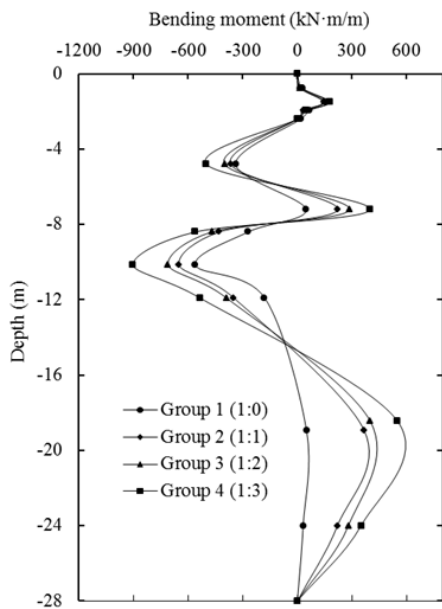

Fig. 8 Bending moment ratio between long pile and short pile

The horizontal displacement curves of piles under various ratios between long pile and short pile are shown in Fig. 9. The effects of ratio on horizontal displacement are obvious at the pile depth below the excavation bottom, and the curves of long pile and short pile are similar. With the increase of short pile proportion, the displacements

towards the excavation increase. The maximum horizontal displacement of long pile and short pile in Group 4 are separately 48mm and 64 mm, which may cause instability of the retaining structure, which may cause instability of the retaining structure.

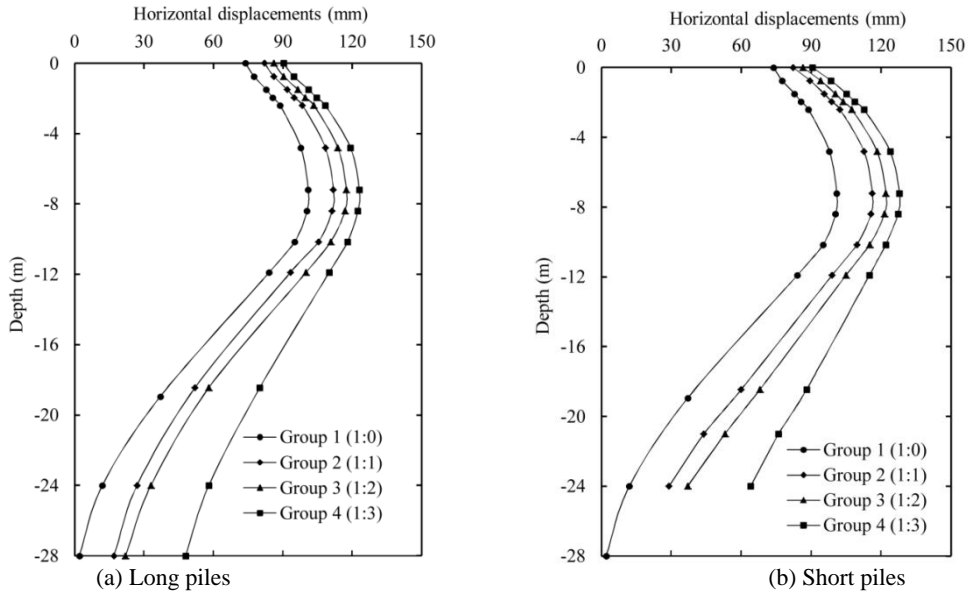

Fig. 9 Horizontal displacement under various ratio between long pile and short pile

The bottom heave curves under various ratios between long pile and short pile are shown in Fig. 10. Unlike Fig. 7, the changes of curves are approximately proportional. The maximum heave is in the center of the excavation width.

On basis of the analyses above, Group 2 is conservative and Group 4 is unsafe. Thus, group 3 (1:2) is the most feasible and economic choice.

To sum up, 28 m long pile and 25 m short pile with ratio 1:2 is adopted as retaining system, as shown in Fig. 11.

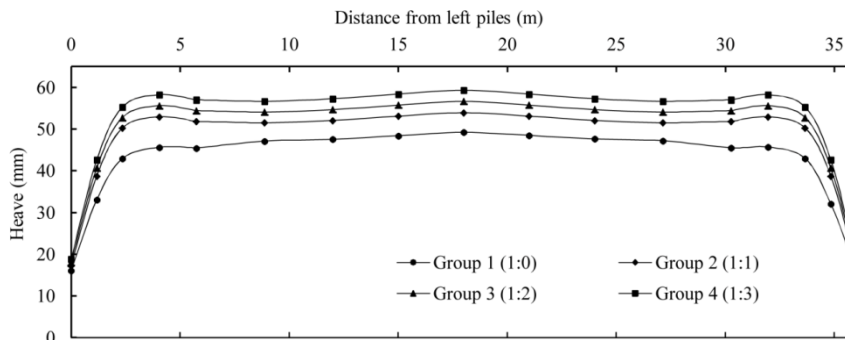

Fig. 10 Bottom heave under various ratio between long pile and short pile

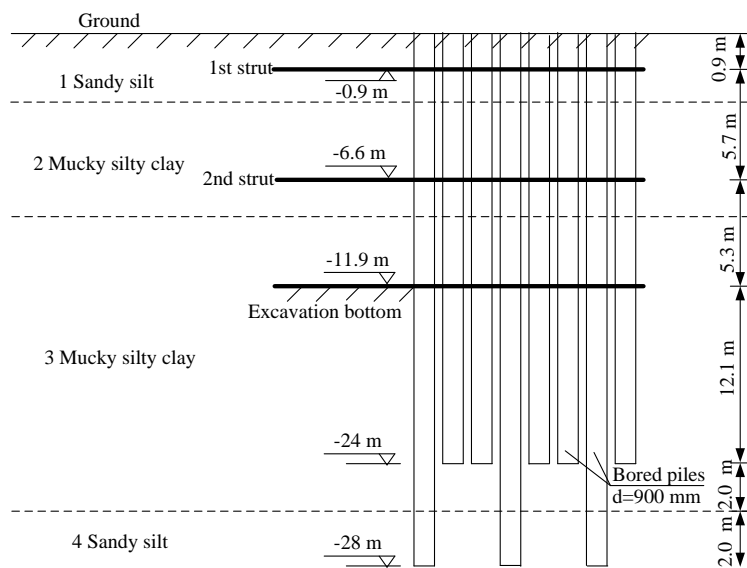

Fig. 11 Sketch of long-short pile system

4. Comparisons between Simulation Results and Field Monitoring Data

To understand the long-short pile retaining system in detail, an excavation project at Hangzhou was used for case study, which has been accomplished and the horizontal displacement and bottom heave were monitored during the excavation. The case information was described before in 3.1 General descriptions. The long pile is 28 m and the short pile is 24 m. Two short piles are located between two long piles, as shown in Fig. 11. The

inclinometer pipes (shown in Fig. 1, every solid disc indicates two inclinometers: one in the long pile, one in the short pile nearby.) were installed inside the piles, which were in accordance with deformation of the piles. Ground surface settlements were measured by optical survey techniques. The field data used for comparisons (No. 3 and No. 8 inclinometer, and the middle dotted line, shown in Fig. 1) are in the same positions as the data used for simulation analyses. The comparisons between field monitoring data and simulation data are shown in Fig. 12 and Fig. 13 at the last excavation stage (excavated to -11.9 m).

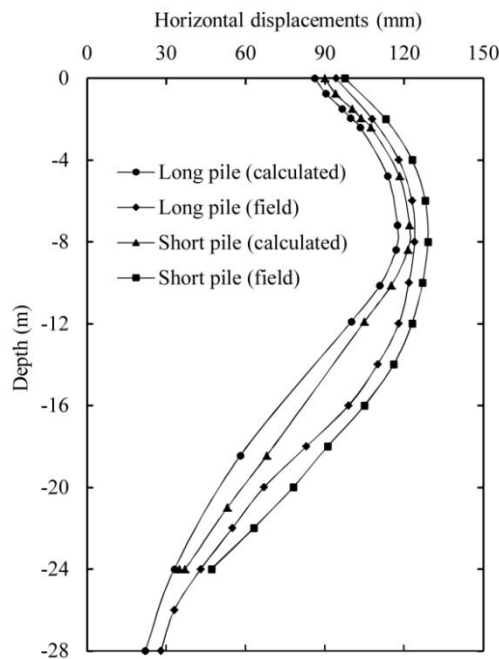

Fig. 12 Horizontal displacement of calculated data and field data

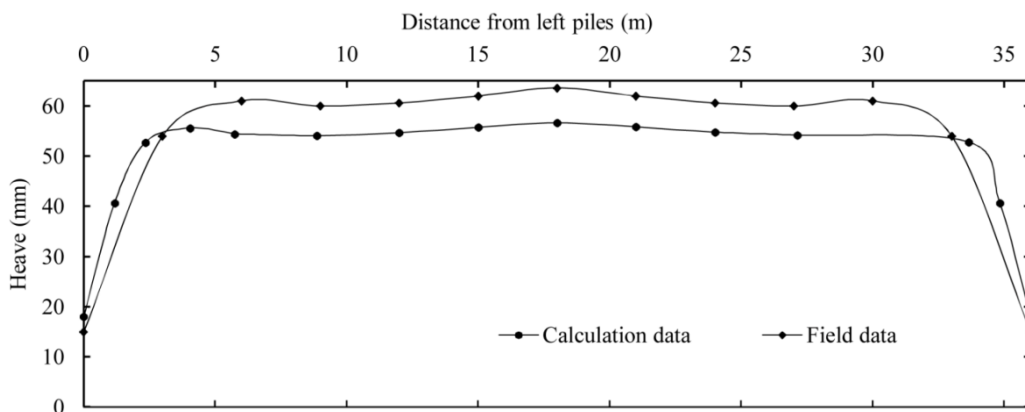

Fig. 13 Bottom heave of calculation data and field data

As the simulation environment is relatively simple, the simulation results of the horizontal displacement are slightly small than the field data. The difference of field monitoring data and simulation data is within 20 % (both the horizontal displacement and the bottom heave), showing that the simulation results are quite consistent with the field data.

The data comparisons above prove that, the long-short pile retaining system can meet the deformation requirements of excavation. The excavation calculated perimeter is 216 m. When one long pile and two short piles system are adopted, 7, 500 t cement and 300 t steel rebar can be saved. Therefore, this new retaining system is worth popularizing in practice.

5 Conclusions

The following conclusions can be drawn from this study:

(1) The short pile length is determined by bottom heave value allowed, and the long short pile ratio is determined by long pile bending moment capacity (the bending moment passed from the pile shorted on to the nearby long pile shall not exceed long pile capacity). These two parameters are not independent. Before deciding the long short pile combination, a lot of simulations and comparisons should be done.

(2) The simplified calculation results and simulation data are consistent. The simulation data show that the effects of pile length on bottom heave are more obvious than on other parameters, and the effects of short pile proportion are more distinct on long pile bending moment than on other parameters.

(3) The comparisons with field data prove the accuracy of simulation results..

(4) The pile length and long-short pile ratio are closely connected with the soil parameters. All these conditions need to be investigated in further study.

Acknowledgments: Thanks are given to people and organizations who contribute to make this project a success. The financial support from the National Natural Science Foundation of China (NSFC Grant No. 51278449 and No. 51238009) and the Jiangxi Province achievement transformation Program (Grant No. KJLD4038) are gratefully acknowledged.

References

- [1] Ou CY. Deep Excavation, Taylor & Francis Group, London, 2006.
- [2] Zhou AQ, Gong XN, Liu HX, Zhang HJ. Research on optimum design of retaining piles structure with interior bracing, Chinese Journal of Rock and soil mechanics, 2010, No. s1, Vol. 31, pp. 245-260.
- [3] Hong SH, Lee FH, Yong KH. Three-dimensional pile-soil interaction in soldier-piled excavations, Computers and Geotechnics, 2003, Vol. 30, pp. 81-107.
- [4] Gao XN, Liu SY, Tong LY. Analysis of ratio of embedded depth of multi-pivot secant piles to excavation depth in suzhou subway stations, Chinese Journal of Southeast University (Natural Science Edition), 2012, No. 2, Vol. 42, pp. 352-357.
- [5] Leung CF, Chow YK, Shen RF. Behavior of pile subject to excavation-induced soil movement, Journal of Geotechnical and Geoenvironmental Engineering, 2000, No. 11, Vol. 126, pp. 947-954.
- [6] Liang FY, Chen LZ, Shi XG. Numerical analysis of composite piled raft with cushion subjected to vertical load, Computers and Geotechnics, 2003, No. 2, Vol. 30, pp. 443-453.
- [7] Wu YD, Shi CH, Liu J, Li ZG. Study on the bearing characteristics of long-short piles composite foundation under embankment load, Forensic Engineering, New York, 2012, pp. 673-681.
- [8] Li Z, Zheng G, Wang HX. model tests on work behaviors of retaining piles with different lengths and horizontal support, Chinese Journal of Geotechnical Engineering, 2010, No. s1, Vol. 32, pp. 440-446.
- [9] Zheng G, Cheng XS. Experimental study on cantilever contiguous retaining piles with different lengths, Chinese Journal of Geotechnical Engineering, 2008, No. s1, Vol. 30, pp. 410-415.
- [10] Faheem HV, Cai F, Ugai K. Two-dimensional base stability of excavations in soft soils using FEM, Computers and Geotechnics, 2003, Vol. 30, pp. 141-163.
- [11] Wong KS. How to avoid failures in deep excavations, International Conference on Structural and Foundation Failures, Singapore, 2004, pp. 384-397.
- [12] Zhang YD, Gong XN. Improvement on basal heave stability analysis for excavations in soft clay, Chinese Journal of Geotechnical Engineering, 2006, No. S1, Vol. 28, pp. 1378-1382.
- [13] Technical Specification for Retaining and Protection of Building Foundation Excavations of the People's Republic of China, Beijing, China Building Industry Press, 2012.
- [14] Technical Code for Monitoring of Building Excavation Engineering of the People's Republic of China, Beijing, China Architecture & Building Press, 2009.
- [15] Brinkgreve RBJ. Selection of soil models and parameters for geotechnical engineering application in soil constitutive models, Proceedings of the Sessions of the Geo-Frontiers Congress, Texas, 2005, pp. 69-98.
- [16] Xu ZH, Wang WD. Selection of soil constitutive models for numerical analysis of deep excavations in close proximity to sensitive properties, Chinese Journal of Rock and Soil Mechanics, 2010, No.1, Vol. 31, pp. 258-264.
- [17] Tolooiyan A, Gavin K. Modelling the cone penetration test in sand using cavity expansion and arbitrary lagrangian eulerian finite element methods, Computers and Geotechnics, 2010, No. 4, Vol. 38, pp. 482-490.