



Modeling and Evaluating the Energy Hub Effects on a Price Responsive Load

M. Aghamohamadi*, M. Samadi*(C.A.) and M. Pirnahad*

Abstract: The integration of different energy types and new technological advances in multi-energy infrastructures, enable energy hubs (EH) to supply load demands at a lower cost which may affect the price responsive loads, since the energy could be offered with a lower price at the EH output ports, compared to the upstream energy markets. In this paper a new EH operation model is proposed by which the optimal responsive load modifications against the obtained EH output energy prices as well as the EH schedules are determined. To achieve this goal, a tri-step approach is proposed. At the first step the EH output energy prices are obtained for each energy type in each hour of the scheduling horizon. These energy prices are based on the EH hourly operation and would change as the EH operation changes. At the second step, the optimal responsive load modifications against the obtained EH output energy prices are simulated using the new proposed integrated responsive load model which is capable to model the price responsive loads in multi-energy systems for any type of energy carrier. Since, any changes in load demand (due to its responsiveness) can jeopardize the EH power balance constraint, the obtained EH operation would be infeasible, considering the new modified load pattern. To cope with this interdependency, a new iterative methodology is proposed at the third step in which, the EH optimal operation + EH output energy price determination + responsive load modification is implemented in a loop till the 24 hour aggregated load modification becomes lower than the pre-determined convergence tolerance. Based on the obtained results from solving the proposed methodology through a comprehensive case study, the aggregated supplied energy has been increased by 7.3%, while, the customers payments has reduced by 14.6%. Accordingly, the customer's satisfaction has increased.

Keywords: Demand Response, Energy Price, Energy Conversion and Storage, Energy Hub, Energy Internet.

Nomenclature

Indices

i	Index of EH input energies.
j	Index of EH output loads.
k	Index of EH energy storages.
t, t'	Index of hour.

Parameters

C_{it}	Price of input carrier i to the EH system in hour t .
C_t	DR-based energy price in hour t .
C_t^{ini}	Initial energy price in hour t .
E_k^l	Energy loss for storage k .
E_{kt}^{up}	Maximum value of E_{kt} .
$G_{tt'}$	Load elasticity between hours t and t' .
H_{ji}	Carrier coupling factor between load j and input energy i .
L_t^{ini}	Initial load in hour t .
L_{jt}^{ini}	Initial load j in hour t belonging to the EH system.
M	Number of EH output loads.

Iranian Journal of Electrical and Electronic Engineering, 2019.

Paper first received 20 May 2018 and accepted 30 July 2018.

* The authors are with the Department of Electrical Engineering, Hakim Sabzevari University, Sabzevar, Iran.

E-mails: m.ghamohamadi@sun.hsu.ac.ir, ma.samadi@hsu.ac.ir and pirnahad.mostafa@gmail.com.

Corresponding Author: M. Samadi.

N	Number of EH input energy carriers.
P_{it}^{up}	Maximum value of P_{it} .
P_{it}^{lo}	Minimum value of P_{it} .
$Q_{kt}^{ch,up}$	Maximum value of Q_{kt}^{ch} .
$Q_{kt}^{dis,up}$	Maximum value of Q_{kt}^{dis} .
S_{jk}	Coupling factor between load j and storage k .
T	Number of hours of the scheduling horizon.
V_j^{SH}	Value of lost load for demand j .
η_{ij}^c	EH converter coupling between input i and output j .
η_k^{ch}	Charging efficiency of storage k .
η_k^{dis}	Discharging efficiency of storage k .

Sets

Ξ^B	Set of binary decision variables.
Ξ^C	Set of continuous decision variables.
Ξ^I	Set of input energy carriers to the EH system.
Ξ^J	Set of EH output loads.
Ξ^K	Set of EH energy storage systems.
Ξ^T	Set of hours of the scheduling horizon.

Continuous Decision Variables

C_{jt}^O	EH energy price for output j in hour t .
E_{kt}	Stored energy level of storage k in hour t .
L_{jt}	Modified load j in hour t .
L_t	Modified elastic load in hour t .
P_{it}	EH input energy i in hour t .
P_{jt}^{SH}	Value of unserved load j in hour t .
Q_{kt}^{dis}	Discharging energy of storage k in hour t .
Q_{kt}^{ch}	Charging energy of storage k in hour t .

Binary Decision Variables

x_{kt}^{ch}	Binary variable indicating charging status of storage k in hour t (1: charging, 0: out-of-use or discharging).
x_{kt}^{dis}	Binary variable indicating discharging status of storage k in hour t (1: discharging, 0: out-of-use or charging).

Vectors/Matrices

CCM	Carrier coupling matrix.
L	Vector of EH output loads.
P	Vector of input energy carriers to energy converter units at the EH input junctions.
Q^{ch}/Q^{dis}	Vector of storage charging/discharging energy.
S	Storage coupling matrix.
η	Converter coupling matrix.

1 Introduction

1.1 Motivation and Background

ENERGY hub (EH) is a recently developed concept employed as an interface between different energy infrastructures and network participants, considered as a promising option for optimal management of multi-energy systems (MES) [1].

This conceptual idea has been exploited to represent the interactions between different energy carriers through new technological advances such as energy storage systems and energy converters. The ability of balancing the energy demand and supply between different types of energy is carried out by the optimal scheduling of converters and storage systems which brings more system flexibility in terms of meeting different types of forecasted demand [2]. So far, Several conceptual approaches for an integrated view of transmission and distribution systems with distributed energy resources have been proposed such as “energy-services supply systems” [3], “basic units” [4], “micro grids” [5], and so-called “hybrid energy hubs” [6].

Compared to micro-grid definition, the energy hub is a more general concept which can model the integration of an arbitrary number of energy carriers and products (i.e., electricity, natural gas, heat, water, etc.), and thus provides higher flexibility in system modeling. For example, the application of EH concept for the characterization of trigeneration devices is reported in [7]. Another application example is the conception of fuel cell systems, which is exemplified in [8]. Models for integrated analysis of energy and transportation systems employing the energy hub concept are also presented in [9].

Practical examples of EH application areas include vast building complexes (e.g., shopping malls, Hospitals, and airports), urban areas, small bounded districts, island power systems (ships, trains), and industrial units such as steel works [10]. So far, numerous studies have pointed out different aspects of employing EH such as security and reliability [11-13], operational optimization [14-16] and long-term/mid-term planning [17-19]. Recently, the EH concept has been employed for other objectives in energy systems such as its application in demand response (DR) schemes. DR is a critical effective measure which can interact as a key role in order to foster a better efficiency and operation in electrical energy systems [20-22]. Integrating different energy carriers and employing new technologies such as energy storage systems and converters have led to a new vision of DR, which is termed as “integrated demand response” (IDR) [23]. IDR can easily make it possible to switch the main source of the consumed energy to provide more flexibility in terms of actively participating in DR programs even for inelastic loads. In [24] an optimization model is proposed to minimize the purchased energy costs of a residential EH, while

scheduling the household utilizations in TBDR programs. In [25] the IDR theory has been established to model the optimal communications between smart EHs and utility companies in order to maximize the customers' benefits due to real-time pricing.

A summary of some recent related works in the area of demand response are compared in the Table 1. In this table, the electricity, natural gas, heat, water and other types of fossil fuel are indicated by E, NG, H, W and M respectively. The phrase "micro-grid" and "virtual power plant" have been also indicated by M-G and VPP respectively.

As it is illustrated in Table 1, the DR programs have been widely employed in several research works such as micro-grids, virtual power plant and energy hub concept. As it is seen, the operation of different energy carriers such as heat, natural gas and water, has been introduced in the EH concept which is due to its important strength point in the integration of different energy carriers. Some relevant works in the area of DR and combined heat and power systems are also presented by [45-47].

Despite the advantages of the reviewed studies, the EH concept has been employed as an interface between upstream energy infrastructures and end users so far. However, such system can also play the role of an energy generation unit which can offer prices to customers based on its energy generation costs. Thanks to the new technological advances and large scale energy storage systems, EH can supply the output load demands at a lower expense. This reduction in cost may increase the satisfaction index for load demands, especially the price-responsive loads that can increase in such circumstances. Therefore, the investigation of the EH generation cost as well as its effects on the responsive loads can be an important issue.

Accordingly, in this research work the expected social benefits pertaining to employing EHs as the main supplier of elastic energy demands is investigated. This social benefit arises from the expected cost reductions in EH structure, compared to energy prices in single energy infrastructures since, a) the energy storage systems can arbitrage between off-peak and peak hours, and b) the integration of different energy carriers, taking advantage of converters and multi-input energy paths, can compensate the shortage of one energy type by other energy carriers. However, how the EH output energy prices are determined, and how this price reduction adjusts the elastic load modifications, has not been studied so far. Accordingly, further studies are needed to be undertaken in order to provide more realistic and promising models for EH operation especially when playing the role of a main supplier.

1.2 Methodology, Contributions and Advantages

In this study, a new operation optimization model for EH system is proposed, which determines the optimal

adjustments of elastic loads at the EH output ports against the EH output energy prices. Additionally, the EH total operation cost as well as the customers' payments are minimized as well.

The main contributions of this paper, can be summarized as follows.

- 1) Since, the EH output prices are the only price signals for customers, a general model is developed to resolve the EH output energy prices first. This model determines the price of each EH output energy in each hour of the scheduling horizon. The EH output prices are determined, considering direct energy flow prices (purchased energy at the input) and converter energy costs, which can be used at the output and/or stored in the storage. Therefore, the obtained EH output energy prices would be subject to the EH operation (i.e., converters energy dispatch and storage operation conditions).
- 2) An integrated responsive load model is proposed to determine the optimal load modifications for any type of energy carrier, within the EH system. The proposed integrated responsive load model is capable to model any type of energy carrier at the EH output such as electricity, heat, water, etc. This model is well adapted with the EH system to capture the maximum benefit of price reduction associated with the optimum coordination of the response of elastic demands to the EH generation cost.
- 3) In this study, a) the EH output energy prices are based on the operation of EH facilities, b) the operation of EH facilities is dependent on the load patterns at the EH output ports, and c) the responsive load patterns are based on the obtained EH output prices. Therefore, there would be an interdependency between the EH output energy price formation, elastic load reactions and EH operation. To cope with this dependency and achieving an optimum solution for mutual benefits of both the utility and customers, a new iterative methodology is proposed in this study. The proposed methodology, includes three main steps. At the first step, the EH operation is optimized regarding the initial load patterns at the EH output ports. At the second step, the EH output energy prices are determined based on the optimal operation of EH facilities (i.e., first contribution). At the third step therefore, the optimal load modifications against the EH output energy prices are determined using the proposed integrated responsive load model (i.e., second contribution). By changing the load demand in response to EH price reductions, the EH optimum solution becomes infeasible since, the equality constraints between demand and supply is now jeopardized (the initial load demand is modified). Accordingly, the EH operation optimization has to be

Table 1 The effects of EH employment.

Ref. No.	Year	App.	DR Model	Renewables	Energy Types
[26]	2018	EH	Shift+Curtail	-	E+NG+H
[27]	2018	EH	Shift+Curtail	Wind+PV	E+NG
[28]	2018	EH	Shift+Curtail	Wind+PV	E
[29]	2018	M-G	Shift	PV	E
[30]	2017	EH	Shift+Curtail	PV	E+NG
[31]	2017	EH	Curtail	Wind+PV	E+NG
[32]	2017	EH	Shift	Wind	E+NG
[33]	2017	EH	Shift	Wind	E+NG+W
[34]	2017	VPP	Shift+Curtail	Wind+PV	E
[35]	2017	M-G	Shift	Wind+PV	E
[36]	2016	EH	Shift	Wind	E+NG+W
[37]	2016	EH	Shift+Curtail	PV	E+M
[38]	2016	VPP	Curtail	-	E
[39]	2016	VPP	Curtail	-	E
[40]	2016	VPP	Curtail	Wind	E
[41]	2016	VPP	Shift+Curtail	Wind+PV	E
[42]	2015	EH	Shift	-	E+NG
[43]	2015	M-G	Curtail	Wind+PV	E
[44]	2014	EH	Shift+Curtail	PV	E+NG

implemented again. The whole procedure therefore, iterates till the 24 hour aggregated load modification becomes lower than the pre-determined convergence tolerance (i.e., ϵ). By solving the proposed model the optimum value of elastic load modifications as well as the optimum EH schedule is obtained.

To the best of authors' knowledge, the above contributions are specific to this paper and have not been presented in the previous research works.

The advantages of this paper, compared to the previous frame works are summarized in the following:

1. In contrast to previous researches that consider EH as a customer (which can purchase energies at the upstream ports, in our study the EH is considered as the main supplier and can offer its output price to the customers.
2. In contrast to previous demand response models that only characterize the electric load patterns, in our study any type of EH output load (i.e., electricity, natural gas, heat, water, etc.) can be considered as a price responsive load which can be modified against the EH output prices, as long as an elasticity is defined for such energy demand.

1.3 Paper Organization

The rest of this paper is organized as follows. The EH formulation and the employed responsive load model have been introduced in Section 2. Section 3 investigates the proposed EH operation optimization model to supply the price responsive load demands. The proposed integrated responsive load model as well as the EH output price determination has been also introduced and discussed in this section. The simulation results are presented in Section 4. Finally, the paper is summarized and concluded in Section 5.

2 Description of the Main Components

2.1 The EH Concept

In contrast to the traditional power delivery methods, EHs can assist as an interface between energy organizations and network contributors (producers, consumers), and between different energy infrastructures, coupling for example electricity and natural gas systems with no connection between sources and loads.

Based on the definitions, the energy hub concept is considered as the cornerstone and core concept of the Energy Internet [48] in today's energy system, since it covers the integration of different energy carriers as well as energy storage systems and energy converters.

The main mechanisms of the EH can be categorized into three parts, namely the energy inputs and outputs, energy converters and energy storage systems. Main modeling and formulation of an EH is proposed at the following [4].

The relationship between input energy carriers and output loads of an EH can be described by a converter coupling matrix η . Converters in an EH include any device taking part in the energy conversion of different input energy carriers. Since, the received energy at the input port may be consumed by several converters (e.g., CHP, furnace and etc.), another coupling factor named "dispatch factor" has to be considered in the formulation of EH. These factors determine how the input energy is distributed among the converters. Therefore, each element of matrix η , (i.e., η_{ij}^c) stands for the production of converters' efficiencies and dispatch factors. The formulation of matrix η is described as (1a). Zero efficiencies in matrix η indicate that the associated energy conversions do not exist in the EH.

$$\begin{bmatrix} L_1 \\ L_2 \\ \vdots \\ L_m \\ L \end{bmatrix} = \underbrace{\begin{bmatrix} \eta_{11}^c & \eta_{21}^c & \dots & \eta_{n1}^c \\ \eta_{12}^c & \eta_{22}^c & \dots & \eta_{n2}^c \\ \vdots & \vdots & \ddots & \vdots \\ \eta_{1m}^c & \eta_{2m}^c & \dots & \eta_{nm}^c \end{bmatrix}}_{\eta} \times \begin{bmatrix} P_1 \\ P_2 \\ \vdots \\ P_n \\ P \end{bmatrix}, \quad (1a)$$

$$0 \leq \eta_{ij}^c \leq 1, 1 \leq i \leq N, 1 \leq j \leq M$$

In addition to converters, and assuming all the energy storages at the output side, the relation between EH inputs and outputs considering converters and storages is as (1b).

$$L = \eta \cdot P - S \cdot Q \quad (1b)$$

Considering binary variables for charging/discharging status of the storage systems, (1b) becomes as (1c).

$$L = \eta \cdot P - S \cdot Q^{ch} + S \cdot Q^{dis} \quad (1c)$$

Interested readers are referred to [4], for more information on the EH and MES modeling.

2.2 The Employed Demand Response Model

The price elasticity of load is modeled by (2a) and (2b) for both cross-elasticity and self-elasticity [23].

$$G_{t,t'} = \frac{C_{t'}^{ini}}{L_t^{ini}} \cdot \frac{\partial L_t}{\partial C_{t'}}; \quad \forall t \in \Xi^T, \forall t' \in \Xi^T \quad (2a)$$

where

$$\begin{cases} G_{t,t'} \leq 0 & \text{if } t = t' \\ G_{t,t'} \geq 0 & \text{if } t \neq t' \end{cases} \quad (2b)$$

If it is assumed that $B(L_t)$ is the customer's benefit pertaining to consumption pattern, the benefit function (OF) for customers is as (2c) [23].

$$OF = \sum_{t \in \Xi^T} B(L_t) - L_t \cdot C_t; \quad \forall t \in \Xi^T \quad (2c)$$

where

$$\Delta L_t = L_t - L_t^{ini}; \quad \forall t \in \Xi^T \quad (2d)$$

According to (2c), we have $\partial OF / \partial L_t = 0$ to maximize the benefit function, which results in the following as (2e) and (2f) [24]:

$$\frac{\partial OF(L_t)}{\partial L_t} = C_t; \quad \forall t \in \Xi^T \quad (2e)$$

$$B(\Delta L_t) = C_t^{ini} (L_t - L_t^{ini}) \cdot \left\{ 1 + \frac{L_t - L_t^{ini}}{2G_{t,t'=t}, L_t^{ini}} \right\}; \quad (2f)$$

$$\forall t \in \Xi^T$$

According to the above the quadratic function of customer's benefit (2f), (2e) becomes as (2g) after some manipulations.

$$L_t = L_t^{ini} \cdot \left\{ 1 + G_{t,t'=t} \cdot \frac{C_t - C_t^{ini}}{C_t^{ini}} \right\}; \quad \forall t \in \Xi^T \quad (2g)$$

Regarding (2g) the load pattern modification has been obtained considering the upstream price variations (i.e., $C_t - C_t^{ini}$) as well as loads' self-elasticities for each hour of the scheduling horizon. This function, considering the cross elasticities, can also be developed as (2h):

$$L_t = L_t^{ini} \cdot \left\{ 1 + \sum_{\substack{t' \in \Xi^T \\ t' \neq t}} G_{t,t'} \cdot \frac{C_{t'} - C_{t'}^{ini}}{C_{t'}^{ini}} \right\}; \quad \forall t \in \Xi^T \quad (2h)$$

The above formulation (i.e., (2h)) indicates the linear connection between energy price variations and demand in $t \neq t'$ periods where the load pattern adjustments are obtained considering the cross elasticities between different hours of the scheduling horizon. According to (2g) and (2h), the multi-period demand adjustments, based on price variations, is presented by (2i). In this equation the load adjustments in period t are dependent on the self-elasticity and the cross-elasticity for both fixed and shiftable load types.

$$L_t = L_t^{ini} \cdot \left\{ 1 + G_{t,t} \cdot \frac{C_t - C_t^{ini}}{C_t^{ini}} + \sum_{\substack{t' \in \Xi^T \\ t \neq t'}} G_{t,t'} \cdot \frac{C_{t'} - C_{t'}^{ini}}{C_{t'}^{ini}} \right\}; \quad (2i)$$

$$\forall t \in \Xi^T$$

3 The Proposed Methodology

This section is dedicated to propose a methodology in order to achieve a well-adjusted optimal point by which the optimal operation of the EH and the elastic load modifications would be determined.

3.1 The Proposed EH Operation Optimization and Output Price Determination

In this paper, it is aimed to minimize the total energy cost which includes the cost of purchased power and the load shedding penalty. Accordingly, the proposed EH operation optimization model is formulated as follows:

$$\min \overbrace{\sum_{t \in \Xi^T} \sum_{i \in \Xi^I} (C_{it} \cdot P_{it})}^{M1} + \overbrace{\sum_{t \in \Xi^T} \sum_{j \in \Xi^J} V_j^{SH} \cdot P_{jt}^{SH}}^{M2} \quad (3a)$$

s.t.:

$$L_{jt}^{ini} = \sum_{k \in \Xi^K} (S_{jk} \cdot Q_{kt}^{dis} - S_{jk} \cdot Q_{kt}^{ch}) + \sum_{i \in \Xi^I} (\eta_{ij}^c \cdot P_{it}) + P_{jt}^{SH}; \quad \forall j \in \Xi^J, \forall t \in \Xi^T \quad (3b)$$

$$E_{kt} = E_{k(t-1)} + \eta_k^{ch} \cdot Q_{kt}^{ch} - \frac{1}{\eta_k^{dis}} \cdot Q_{kt}^{dis} - E_k^l; \quad \forall k \in \Xi^K, \forall t \in \Xi^T \quad (3c)$$

$$\sum_{t \in \Xi^T} \left(\eta_k^{ch} \cdot Q_{kt}^{ch} - \frac{1}{\eta_k^{dis}} \cdot Q_{kt}^{dis} \right) = T \cdot E_k^l; \quad k \in \Xi^K \quad (3d)$$

$$P_{it}^{lo} \leq P_{it} \leq P_{it}^{up}; \quad \forall i \in \Xi^I, \forall t \in \Xi^T \quad (3e)$$

$$0 \leq Q_{kt}^{ch} \leq Q_{kt}^{ch,up} \cdot x_{kt}^{ch}; \quad \forall k \in \Xi^K, \forall t \in \Xi^T \quad (3f)$$

$$0 \leq Q_{kt}^{dis} \leq Q_{kt}^{dis,up} \cdot x_{kt}^{dis}; \quad \forall k \in \Xi^K, \forall t \in \Xi^T \quad (3g)$$

$$0 \leq E_{kt} \leq E_{kt}^{up}; \quad \forall k \in \Xi^K, \forall t \in \Xi^T \quad (3h)$$

$$0 \leq P_{jt}^{SH} \leq L_{jt}^{ini}; \quad \forall j \in \Xi^J, \forall t \in \Xi^T \quad (3i)$$

$$x_{kt}^{ch} + x_{kt}^{dis} \leq 1; \quad \forall k \in \Xi^K, \forall t \in \Xi^T \quad (3j)$$

$$\forall P_{it}, \forall P_{jt}^{SH}, \forall Q_{kt}^{ch}, \forall Q_{kt}^{dis}, \forall E_{kt} \in \mathbb{R};$$

$$\forall x_{kt}^{ch}, \forall x_{kt}^{dis} \in \{0,1\} \quad (3k)$$

The cost of purchased input energy to the EH (i.e., the first summation) as well as load shed penalties (i.e., the second summation) are minimized through the objective function in (3a). The equality constraint pertaining to the power flow between input and output ports of the HE is modeled through (3b). The equality constraint for storage charging discharging and the end coupling constraints for the storage systems are illustrated in (3c) and (3d), respectively. Constraints (3e), (3f)-(3g), (3h), and (3i) bound the EH purchased energies, charged/discharged energies at the storage systems, level of storage systems, and load shedding to the acceptable ranges, respectively. Constraint (3j) makes sure that each energy storage system would operates in one operation condition (charge or discharge) in each hour of the scheduling horizon. Since, the delivered energy to the output is a combination of upstream purchased energy and converter outputs. Therefore, (3l) is proposed to determine the hourly electricity price.

$$C_{jt}^o = \frac{\sum_{i \in \Xi^I, |i|=2} (C_{it}^o \cdot P_{it} \cdot \eta_{ij}^c)}{\sum_{t=1}^{24} (L_{jt} + \eta_k^{ch} \cdot Q_{kt}^{ch})}; \quad \forall j \in \Xi^J, \forall t \in \Xi^T \quad (3l)$$

Considering (3l), the output electricity price would be illustrated as a combination of input energies directed to the output ports of the EH, and the converters' output energies.

3.2 The Suggested Integrated Load Responsiveness

In this section, a new integrated responsive load model has been suggested as (4a) which demonstrates how the EH output responsive load demands react in facing the price reductions due to EH employment.

$$L_{jt} = L_{jt}^{ini} \left\{ 1 + \left(G_{it} \cdot \eta_{it'} \cdot \frac{C_{jt}^o - \sum_{i \in \Xi^I} (H_{ji} \cdot (C_{it}^{ini}))}{\sum_{i \in \Xi^I} (H_{ji} \cdot C_{it}^{ini})} \right) \right\};$$

$$+ \left(\sum_{t' \in \Xi^T, t' \neq t} G_{it'} \cdot \frac{C_{jt'}^o - \sum_{i \in \Xi^I} (H_{ji} \cdot (C_{it'}^{ini}))}{\sum_{i \in \Xi^I} (H_{ji} \cdot C_{it'}^{ini})} \right) \}; \quad \forall j \in \Xi^J, \forall t \in \Xi^T \quad (4a)$$

where $\left(C_{jt}^o - \sum_{i \in \Xi^I} (H_{ji} \cdot (C_{it}^{ini})) \right)$ and $\left(C_{jt'}^o - \sum_{i \in \Xi^I} (H_{ji} \cdot (C_{it'}^{ini})) \right)$

in(4a), function as $(C_{jt}^o - \sum_{i \in \Xi^I} (H_{ji} \cdot (C_{it}^{ini}))$ and $(C_{jt'}^o - \sum_{i \in \Xi^I} (H_{ji} \cdot (C_{it'}^{ini}))$ in (2i), respectively. Accordingly, the comparison of initial and new energy prices, resulting to comprehend the associated price changes in a single energy infrastructure, can be also undertaken for other types of energy types, belonging to an EH system. Since, the initial energy prices are placed at the input port of the EH and the new energy prices due to EH employment are placed at the output port of the EH, the comparison between energy prices to illustrate the associated price changes, is undertaken using the proposed carrier coupling matrix **CCM**, in which the elements H_{ij} represent the carrier coupling factors, to compare each EH output net energy price (i.e., C_{jt}^o) to its initial hourly price at the upstream network. Accordingly, the mathematical formulation pertaining to matrix **CCM** is indicated through (4b) and (4c):

$$\mathbf{CCM} = \begin{bmatrix} H_{11} & H_{21} & \dots & H_{m1} \\ H_{12} & H_{22} & \dots & H_{m2} \\ \vdots & \vdots & \ddots & \vdots \\ H_{1n} & H_{2n} & \dots & H_{mn} \end{bmatrix}; \quad (4b)$$

$$\forall H_{ji} \in \{0,1\}; \quad 1 \leq i \leq n; \quad 1 \leq j \leq m \quad (4c)$$

Accordingly, the proposed responsive load model (i.e., (4a)) can model the responsiveness of any type of EH output load demand (i.e., electricity, heat, water, etc.) to be participated in price-based DR programs.

3.3 Main Approach

According to (3) and (4), a tri-step iterative procedure is proposed by which the optimum solution to the EH operation optimization and customer's benefit function is obtained.

The main undertaken steps are as follows:

- (1) At the first step, the EH operation optimization is implemented with respect to (3a)-(3k). The EH operation is optimized to meet the initial load demand at the first iteration of the proposed methodology.
- (2) At the second step, the EH output energy prices are determined with respect to (3l).
- (3) Considering the obtained EH output prices, the elastic load demand is modified due to the principles of (4a). since, the equality constraints between demand and supply is now jeopardized (the initial load demand is modified), the EH

operation optimization has to be implemented again.

This method is executed until the problem converges (the value of load changes in two consecutive iteration, become lower than ϵ). The flowchart of the proposed methodology is illustratively given by Fig. 1. This flowchart demonstrates the construction and data flow between the main parts of the proposed methodology.

4 Case Study

4.1 Data Set

The proposed model is implemented on a case study which is configured as Fig. 2. The under study energy hub contains three input carriers at the EH input ports including electricity P_1 , natural gas P_2 , and direct heat P_3 . The EH output energy demands are considered electricity L_1 and heat demand L_2 . This energy carriers are all in perunit. Efficiencies for transformer unit, CHP unit, and heat exchanger unit are considered as 0.98, 0.77 (0.37 for electricity and 0.4 for heat) and 0.9, respectively [4]. The Load demand parameters and the associated elasticities, have been obtained from [25] and [23] respectively. It deserves mentioning that, both the self-elasticities and cross elasticities pertaining to heat demand are assumed to be zero (i.e., heat demand is inelastic).

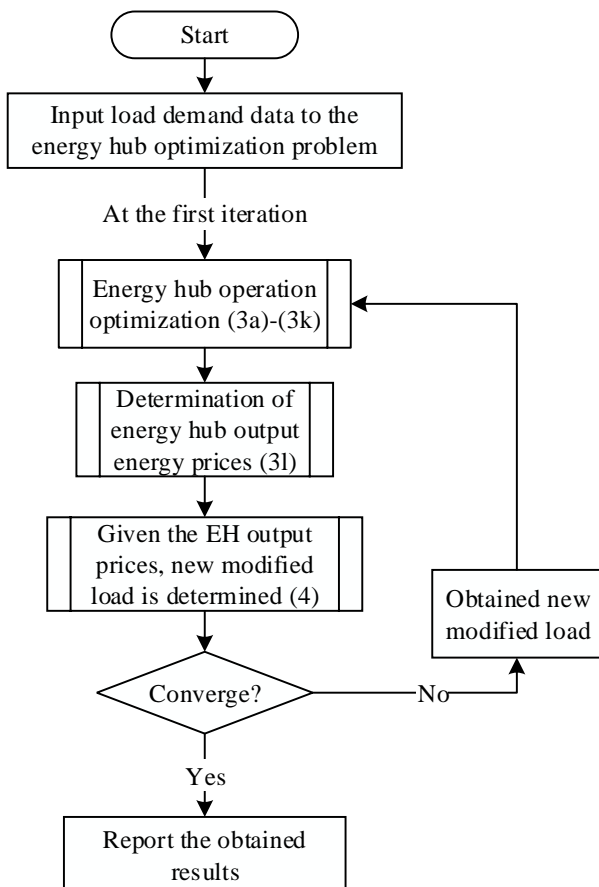

Fig. 1 The flowchart of the proposed methodology.

4.2 Simulation Results

The simulations of this section have been conducted on two scenarios. At the first scenario the electric load demand is modified in response to the upstream time-of-use (TOU) tariff prices, while no EH is employed. This modification has been implemented based on the responsive load model (2) for the electric load. This scenario is conducted to determine the actual expected load modifications at the absence of EH. The second scenario is then implemented, based on the proposed methodology in this paper. The obtained results of these scenarios are then compared to investigate the contribution of the proposed methodology in EH price reductions and elastic load modifications.

4.2.1 Scenario No. 1

The initial load demand data are modified at the absence of the EH, facing upstream time-of-use electricity prices with respect to the flat rate tariffs. The price responsive electric load consumption pattern is shown by Fig. 3. As it is observed, the optimal value of load modification is shown by bar chart. This can be a considerable load reduction, in terms of maximizing the customer's benefit. However, this reduction in load can decrease the customer's comfort as well.

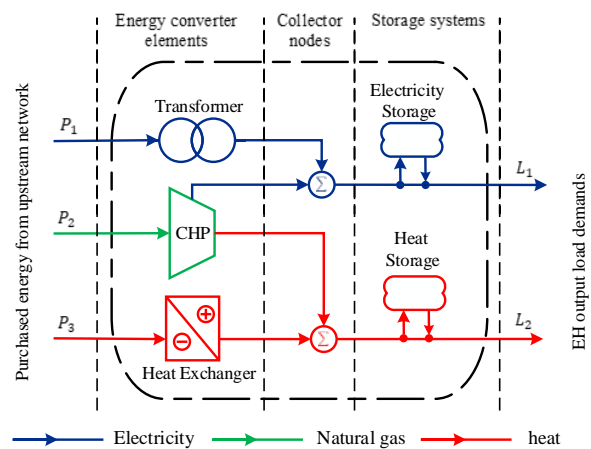

Fig. 2 The employed EH.

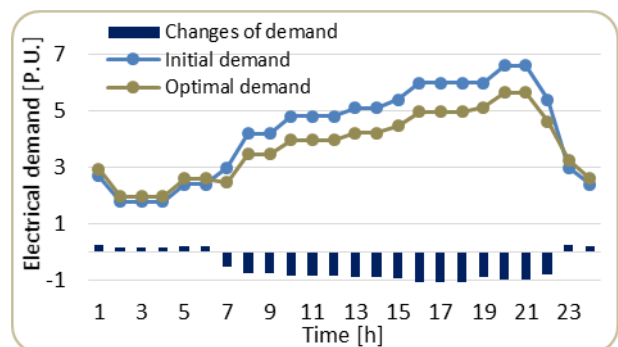

Fig. 3 Optimal electrical consumption pattern in the absence of the EH.

4.2.2 Scenario No.2

The EH, configured by Fig. 2, is employed to supply the customer’s demand. Considering the data set presented in section 4.1, the proposed model is implemented and solved. As it is shown by Fig. 4, the optimum value of modified electricity demand is increased with respect to the modified electricity demand in scenario No.1. This is due to the reduction of EH output electricity prices, comparing to the upstream network prices, facing TOU tariff schemes. In this regard, customer satisfaction would be increased considering the small changes in consumption pattern. As it is shown by Fig. 4, the optimal consumption pattern is increased in peak load periods which is because of the price reduction in these hours due to EH employment. It is expected that the share of gas utilization increases considering its low price which directly affects the EH output prices, especially in peak periods.

According to Fig. 3 and 4, the bar charts, indicating the load demand modifications are compared simultaneously in Fig. 5. Considering Fig. 5 it is shown that the customer’s electrical demand experiences lower changes at the presence of EH, with respect to EH absence. Accordingly, in order to evaluate the customer satisfaction a new index is proposed as (5).

$$CSI_j = \frac{1}{\sqrt{\sum_{t \in \Xi'} (L_{jt}^{mi} - L_{jt})^2}}; \quad \forall j \in \Xi' \quad (5)$$

According to (5), the value of customer’s satisfaction has an inverse relationship with price changes which

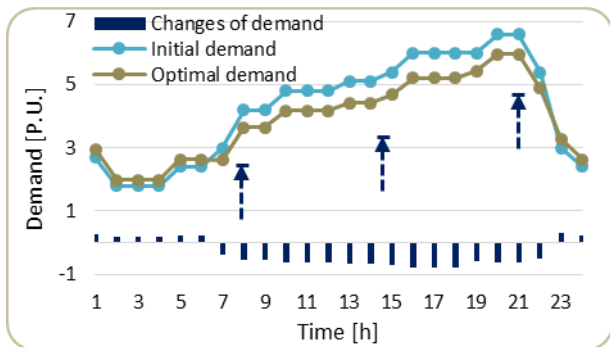

Fig. 4 Optimal electrical consumption pattern in the presence of the EH.

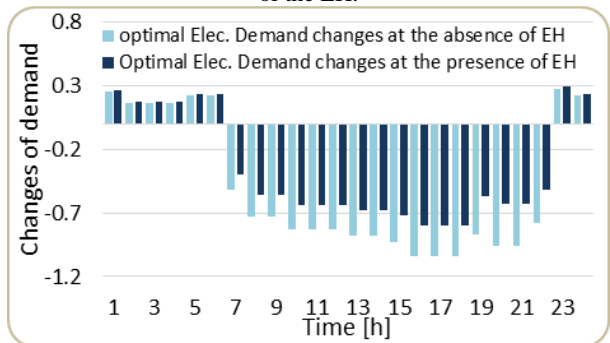

Fig. 5 Demand changes of responsive load in presence and absence of the EH.

leads to a more reduction in consumption pattern.

In this regard the mentioned factor is 0.28 at the absence of EH which has been increased to 0.38, by using the EH as an interface between the price responsive load and the upstream network.

Price changes are presented as Fig. 6 which shows significant reduction of output electricity prices, especially at peak hours. As it is illustrated in Fig. 6, the line graph is the upstream network electricity price which has been modified using the EH. The main reason is that the CHP and the storage provides the electricity at peak hours which is more economic than using the input electricity, with respect to the low price of gas.

The optimal amount of input energy carriers to the EH is shown by Fig. 7. As it is shown, the gas input is increased at peak hours (16-22), which is because of the increase of electrical energy produced by CHP in order to provide an optimal operation of EH considering the high input electricity prices in these periods.

Fig. 8 also represents the input and output electrical energy for the proposed hub. As it can be seen, the output electrical energy usage is higher than the input for hour 9-22. The shaded area shows the sum of energy recovery by CHP and storage.

Considering Fig. 8, the share of CHP electrical energy production has been increased in peak hours, which is also illustrated by Fig. 8 considering the increase of gas input energy to the EH especially in hours 17-22.

A brief explanation of the above results is presented by Table 2. Considering Table 2, it has been shown that the customer can consume a higher value of energy by paying a lower cost. The average price is also presented.

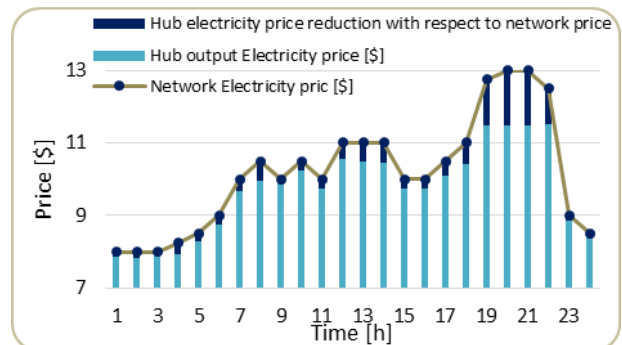

Fig. 6 Input and output side hourly electricity prices.

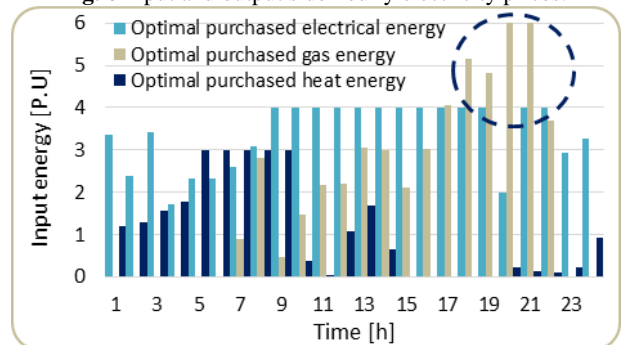

Fig. 7 Optimal purchased energy by the EH.

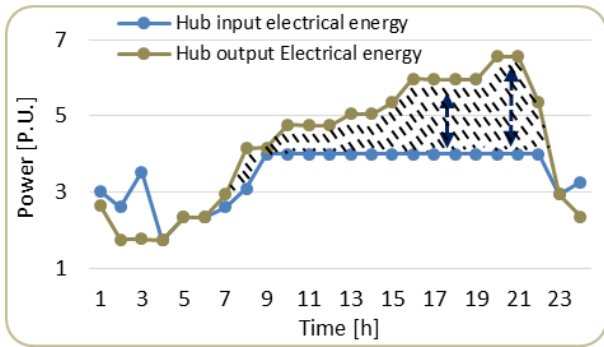

Fig. 8 Purchased electrical energy VS output electricity usage.

Table 2 The literature survey.

	System without	System with
	HUB	HUB
Total power supply [p.u.]	90.2	96.8
Cost of power supply [\$]	955.1	815.5
Average price [\$]	10.6	10

Therefore, according on the above observations, the aggregated supplied energy has been increased by 7.3%, while, the customers payments has reduced by 14.6%. These values have been obtained after 18 iterations and 34.79s of computation time. The simulations of this paper have been run within MATLAB software package [49] on a laptop computer with 8 GB RAM and a core-i7 processor.

The global optimum of the proposed solution approach is guaranteed, since the proposed min-max-min ARO model has been formulated as a linear and convex optimization problem, [50].

5 Conclusion

This paper presents a new EH operation model to investigate the optimum pattern modifications of a price responsive load, at the presence of an energy hub (EH) as the main supplier. In order to achieve this goal, EH output energy prices has been determined based on the direct energy flow from the EH input ports. The responsive load modifications has been also simulated through the proposed integrated responsive load model. According to the obtained results, the EH proved to be able to reduce the energy prices. On the other hand, it is pointed out that the consumer’s comfort has improved as well, since, more energy has been delivered by the EH at a lower expense. Accordingly, the customer’s satisfaction increases by the use of EH as the main supplier since, the aggregated supplied energy has been increased by 7.3%, while, the customers payments has reduced by 14.6%. According to the obtained results and observations, developing the proposed model considering uncertainty sources, would be a future work.

References

- [1] P. Favre-Perrod, “A vision of future energy networks,” in *Power Engineering Society Inaugural Conference and Exposition in Africa*, pp. 13–17, Apr. 2006. DOI:10.1109/PESAFR.2005.1611778.
- [2] M. Geidl and G. Andersson, “Optimal power flow of multiple energy carriers,” *IEEE Transactions on Power Systems*, Vol. 22, No. 1, pp. 145–155, Jan. 2007.
- [3] H. M. Groscurth, T. Bruckner, and R. Kummel. “Modeling of energy-services supply systems,” *Energy*, Vol. 20, No. 9, pp. 941–958, 1995.
- [4] I. Bouwmans and K. Hemmes. “Optimising energy systems— hydrogen and distributed generation,” in *2nd International Symposium on Power System Market Aspects*, Stockholm, Sweden, Oct. 2002.
- [5] R. H. Lasseter, “Microgrids,” in *Proceeding of IEEE Power Engineering Society Winter Meeting*, New York, USA, Jan. 2002.
- [6] R. Friik and P. Favre-Perrod, “Proposal for a multifunctional energy bus and its interlink with generation and consumption,” *Diploma Thesis*, High Voltage Laboratory, ETH Zurich, 2004.
- [7] G. Chicco and P. Mancarella, “A comprehensive approach to the characterization of trigeneration systems,” in *6th World Energy System Conference*, Turin, Italy, Jun. 2006.
- [8] K. Hemmes, J. L. Zachariah-Wolff, M. Geidl, and G. Andersson, “Towards multi-source multi-product energy systems,” *International Journal of Hydrogen Energy*, Vol. 32, No. 10–11, pp. 1332–1338, 2007.
- [9] B. Marti, “Integrated analysis of energy and transportation systems,” *Master Thesis*, Power Systems Laboratory, ETH Zurich, 2006.
- [10] M. Geidl, *Integrated modeling and optimization of multi-carrier energy systems*. Eidgenössische Technische Hochschule Zurich, 2007.
- [11] G. Koepfel, *Reliability considerations of future energy systems: multi-carrier systems and the effect of energy storage*. Zurich: Swiss Federal Institute of Technology, 2007.
- [12] G. Koepfel and G. Andersson, “Reliability modeling of multi-carrier energy systems,” *Energy*, Vol. 34, No. 3, pp. 235–244, March 2009.
- [13] M. Shariatkhah, M. Haghifam, M. Parsa-Moghaddam and P. Siano, “Modeling the reliability of multi-carrier energy systems considering dynamic behavior of thermal loads,” *Energy Build.*, Vol. 103, pp. 375–383, Sep. 2015.

- [14] M. C. Bozchalui, S. A. Hashmi, H. Hassen, C. A. Canizares and K. Bhattacharya, "Optimal operation of residential energy hubs in smart grids," *IEEE Transactions on Smart Grid*, Vol. 3, No. 4, pp. 1755–1766, Dec. 2012.
- [15] S. Paudyal, C. A. Cañizares and K. Bhattacharya, "Optimal operation of industrial energy hubs in smart grids," *IEEE Transactions on Smart Grid*, Vol. 6, No. 2, pp. 684–694, Mar. 2015.
- [16] A. D. Ondeck, T. F. Edgar, M. Baldea, "Optimal operation of a residential district-level combined photovoltaic/natural gas power and cooling system," *Applied Energy*, Vol. 156, pp. 593–606, Oct. 2015.
- [17] X. Zhang, M. Shahidehpour, A. Alabdulwahab and A. Abusorrah, "Optimal expansion planning of energy hub with multiple energy infrastructures," *IEEE Transactions on Smart Grid*, Vol. 6, No. 5, pp. 2302–2311, Sep. 2015.
- [18] X. Zhang, L. Che, M. Shahidehpour, A. Alabdulwahab and A. Abusorrah, "Reliability based optimal planning of electricity and natural gas interconnections for multiple energy hubs," *IEEE Transactions on Smart Grid*, Vol. 8, No. 4, pp. 1658–1667, Jul. 2017.
- [19] M. Salimi, H. Ghasemi, M. Adelpour and S. Vaez-Zadeh, "Optimal planning of energy hubs in interconnected energy systems: a case study for natural gas and electricity," *IET Generation, Transmission & Distribution*, Vol. 9, No. 8, pp. 695–707, May 2015.
- [20] M. Aghamohamadi and N. Amjady, "Modelling and optimization for costly efficiency improvements on residential appliances considering consumer's income level," *IET Generation, Transmission & Distribution*, Vol. 11, No. 16, pp. 3992–4001, Sep. 2017.
- [21] M. Rahmani-andebili, "Modeling nonlinear incentive-based and price-based demand response programs and implementing on real power markets," *Electric Power System Research*, Vol. 132, pp. 115–124, Mar. 2015.
- [22] Staff Report, *Assessment of demand response and advanced metering*. Aug. 2006. <http://www.FERC.gov>.
- [23] J. Wang, H. Zhong, Z. Ma, Q. Xia, and C. Kang, "Review and prospect of integrated demand response in the multi-energy system," *Applied Energy*, Vol. 202, pp. 772–782, Sep. 2017.
- [24] A. Ondeck, T. Edgar, and M. Baldea, "Optimal operation of a residential district-level combined photovoltaic/natural gas power and cooling system," *Applied Energy*, Vol. 156, pp. 593–606, Oct. 2015.
- [25] S. Bahrami and A. Sheikhi, "From demand response in smart grid toward integrated demand response in smart energy hub," *IEEE Transactions on Smart Grid*, Vol. 7, No. 2, pp. 650–658, Mar. 2016.
- [26] M. Aghamohamadi, M. Hajiabadi, and M. Samadi, "A novel approach to multi energy system operation in response to DR programs; an application to incentive-based and time-based schemes," *Energy*, Vol. 156, pp. 534–547, Aug. 2018.
- [27] M. H. Shams, M. Shahabi, and M. E. Khodayar, "Stochastic day-ahead scheduling of multiple energy Carrier microgrids with demand response," *Energy*, Vol. 155, pp. 326–338, Jul. 2018.
- [28] L. Ju, H. Li, J. Zhao, K. Chen, Q. Tan, and Z. Tan, "Multi-objective stochastic scheduling optimization model for connecting a virtual power plant to wind-photovoltaic-electric vehicles considering uncertainties and demand response," *Energy Conversion and Management*, Vol. 128, pp. 160–177, Nov. 2016.
- [29] M. H. Imani, M. J. Ghadi, S. Ghavidel, and L. Li, "Demand response modeling in microgrid operation: a review and application for incentive-based and time-based programs," *Renewable and Sustainable Energy Reviews*, Vol. 94, pp. 486–499, Oct 2018.
- [30] D. Huo, C. Gu, G. Yang, and S. L. Blond, "Combined domestic demand response and energy hub optimisation with renewable generation uncertainty," *Energy Procedia*, Vol. 142, pp. 1985–1990, Dec. 2017.
- [31] C. Timothée, A. T. D. Perera, J. L. Scartezzini, and D. Mauree, "Optimum dispatch of a multi-storage and multi-energy hub with demand response and restricted grid interactions," *Energy Procedia*, Vol. 142, pp. 2864–2869, Dec. 2017.
- [32] A. Dolatabadi and B. Mohammadi-Ivatloo, "Stochastic risk-constrained scheduling of smart energy hub in the presence of wind power and demand response," *Applied Thermal Engineering*, Vol. 123, pp. 40–49, Aug. 2017.
- [33] M. Majidi, S. Nojavan, and K. Zare "A cost-emission framework for hub energy system under demand response program," *Energy*, Vol. 134, pp. 157–166, Sep. 2017.
- [34] Z. Tan, G. Wang, L. Ju, Q. Tan, and W. Yang, "Application of CVaR risk aversion approach in the dynamical scheduling optimization model for virtual power plant connected with wind-photovoltaic-energy storage system with uncertainties and demand response," *Energy*, Vol. 124, pp. 198–213, Apr. 2017.

- [35] G. R. Aghajani, H. A. Shayanfar, and H. Shayeghi, "Demand side management in a smart micro-grid in the presence of renewable generation and demand response," *Energy*, Vol. 126, pp. 622–637, May 2017.
- [36] S. Pazouki and M. R. Haghifam, "Optimal planning and scheduling of energy hub in presence of wind, storage and demand response under uncertainty," *International Journal of Electrical Power & Energy Systems*, Vol. 80, pp. 219–239, Sep. 2016.
- [37] M. Batić, N. Tomašević, G. Beccuti, T. Demiray, and S. Vraneš, "Combined energy hub optimisation and demand side management for buildings," *Energy Systems*, Vol. 127, pp. 229–241, Sep. 2016.
- [38] H. Cui, F. Li, Q. Hu, L. Bai, and X. Fang, "Day-ahead coordinated operation of utility-scale electricity and natural gas networks considering demand response based virtual power plants," *Applied Energy*, Vol. 176, pp. 183–195, Aug. 2016.
- [39] D. Lee, D. Park, J. B. Park, and K. Y. Lee, "Security-constrained unit commitment considering demand response resource as virtual power plant," *IFAC-PapersOnLine*, Vol. 49, No. 27, pp. 290–295, 2016.
- [40] S. M. Nosratabadi, R. Hooshmand, and E. Gholipour, "Stochastic profit-based scheduling of industrial virtual power plant using the best demand response strategy," *Applied Energy*, Vol. 16, pp. 590–606, Feb. 2016.
- [41] L. Ju, Z. Tan, J. Yuan, Q. Tan, H. Li, and F. Dong, "A bi-level stochastic scheduling optimization model for a virtual power plant connected to a wind–photovoltaic–energy storage system considering the uncertainty and demand response," *Applied Energy*, Vol. 171, pp. 184–199, Jun. 2016.
- [42] A. Sheikhi, S. Bahrani, and A. M. Ranjbar, "An autonomous demand response program for electricity and natural gas networks in smart energy hubs," *Energy*, Vol. 89, pp. 490–499, Sep. 2015.
- [43] G. R. Aghajani, H. A. Shayanfar, and H. Shayeghi, "Presenting a multi-objective generation scheduling model for pricing demand response rate in micro-grid energy management," *Energy Conversion and Management*, Vol. 106, pp. 308–321, Dec. 2015.
- [44] F. Brahman, M. Honarmand, and S. Jadid, "Optimal electrical and thermal energy management of a residential energy hub, integrating demand response and energy storage system," *Energy and Buildings*, Vol. 90, pp. 65–75, Mar. 2015.
- [45] M. Alipour, K. Zare, and B. Mohammadi-Ivatloo, "Short-term scheduling of combined heat and power generation units in the presence of demand response programs," *Energy*, Vol. 71, pp. 289–301, Jul. 2014.
- [46] T. R. Nudell, M. Brignone, M. Robba, A. Bonfiglio, F. Delfino, and A. Annaswamy, "A dynamic market mechanism for combined heat and power microgrid energy management," *IFAC-PapersOnLine*, Vol. 50, pp. 10033–10039, Jul. 2017.
- [47] M. H. Abbasi, A. Rajabi, M. Taki, L. Li, J. Zhang, S. Ghavidel, and M. J. Ghadi "Risk-constrained offering strategies for a price-maker demand response aggregator," in *20th International Conference on Electrical Machines and Systems (ICEMS)*, Sydney, NSW, pp. 1–6, 2017.
- [48] K. Zhou, S. Yang, and Z. Shao, "Energy internet: the business perspective," *Applied Energy*, Vol. 178, pp. 212–222, Sep. 2016. DOI:10.1016/j.apenergy.2016.06.052.
- [49] www.mathworks.com.
- [50] M. S. Bazaraa, J. J. Jarvis, and H. D. Sherali, *Linear programming and network flows*. 4th Ed., New Jersey: John Wiley & Sons, 2010.



M. Aghamohamadi was born in 1990 in Sabzevar, Iran. He received the B.Sc. degree from Islamic Azad University, Sabzevar branch, in 2012, and the M.Sc. degree from Hakim Sabzevari University, Sabzevar, Iran, in 2015, both in Electrical Engineering. Currently, he is a Research Assistant in Hakim Sabzevari University, Sabzevar, Iran. His research interests include power system operation and optimization, multi-energy systems, energy storage systems, robust and adaptive robust optimization, and demand response.



M. Samadi was born in 1983 in Mashhad, Iran. He received the B.Sc. degree from Shahed University, Tehran, Iran, in 2005, M.Sc. and Ph.D. degree from Ferdowsi University, Mashhad, Iran, in 2008 and 2013 respectively. Currently, he is an Assistant Professor in Hakim Sabzevari University, Sabzevar, Iran. His research interests include power system operation and optimization, multi-energy systems, and demand response.



M. Pirnahad was born in 1990 in Sabzevar, Iran. He received the B.Sc. degree from Islamic Azad University, Sabzevar branch, in 2013, and the M.Sc. degree from Hakim Sabzevari University, Sabzevar, Iran, in 2015, both in Electrical Engineering. His research interests include power system operation and optimization.



© 2019 by the authors. Licensee IUST, Tehran, Iran. This article is an open access article distributed under the terms and conditions of the Creative Commons Attribution-NonCommercial 4.0 International (CC BY-NC 4.0) license (<https://creativecommons.org/licenses/by-nc/4.0/>).