

Joint Closed-Loop Power Control and Base Station Assignment for DS-CDMA Receiver in Multipath Fading Channel with Adaptive Beamforming Method

M. Dosaranian Moghadam*, H. Bakhshi** and G. Dadashzadeh**

Abstract: In this paper, we propose smart step closed-loop power control (SSPC) algorithm and base station assignment based on minimizing the transmitter power (BSA-MTP) technique in a direct sequence-code division multiple access (DS-CDMA) receiver in the presence of frequency-selective Rayleigh fading. This receiver consists of three stages. In the first stage, with conjugate gradient (CG) adaptive beamforming algorithm, the desired users' signal in an arbitrary path is passed and the inter-path interference is canceled in other paths in each RAKE finger. Also in this stage, the multiple access interference (MAI) from other users is reduced. Thus, the matched filter (MF) can be used for the MAI reduction in each RAKE finger in the second stage. Also in the third stage, the output signals from the matched filters are combined according to the conventional maximal ratio combining (MRC) principle and then are fed into the decision circuit of the desired user. The simulation results indicate that the SSPC algorithm and the BSA-MTP technique can significantly improve the network bit error rate (BER) in comparison with other algorithms. Also, we observe that significant savings in total transmit power (TTP) are possible with our proposed methods.

Keywords: Adaptive Beamforming, Base Station Assignment, Closed-Loop Power Control, DS-CDMA.

1 Introduction

Code-division multiple access (CDMA) for cellular communication networks requires the implementation of some forms of adaptive power control. In the uplink of CDMA systems, the maximum number of supportable users per cell is limited by multipath fading, shadowing, and near-far effects that cause fluctuations of the received power at the base station (BS). Two types of power control are often considered: closed-loop power control and open-loop power control [1], [2]. In a closed-loop power control, according to the received signal power at a base station, the base station sends a command to a mobile set to adjust the transmit power of the mobile. Also, closed-loop power control is employed to combat fast channel fluctuations due to fading. Closed-loop algorithms can effectively

compensate fading variations when the power control updating time is smaller than the correlation time of the channel. However, in an open-loop power control, a mobile user adjusts its transmit power according to its received power in the downlink [1]-[5]. In this work, we present an adaptive closed-loop power control algorithm.

Diversity and power control are two effective techniques for enhancing the signal-to-interference-plus-noise ratio (SINR) for wireless networks. Diversity exploits the random nature of radio propagation by finding independent (or, at least, highly uncorrelated) signal paths for communication. If one radio path undergoes a deep fade, another independent path may have a strong signal. By having more than one path to select from, the SINR at the receiver can be improved. The diversity scheme can be divided into three methods: 1) the space diversity; 2) the time diversity; 3) the frequency diversity. In these schemes, the same information is first received (or transmitted) at different locations (or time slots/frequency bands). After that, these signals are combined to increase the received SINR. The antenna array is an example of the space

Iranian Journal of Electrical & Electronic Engineering, 2010.

Paper first received 6 Feb. 2010 and in revised form 18 July 2010.

* The Author is with Department of Electrical Engineering, Islamic Azad University, Science and Research Branch, Tehran, Iran.

E-mail: m_dmoghadam@qiau.ac.ir.

** The Authors are with the Electrical Engineering Department, University of Shahed, Tehran, Iran.

E-mails: bakhshi@shahed.ac.ir, gdadashzadeh@shahed.ac.ir.

diversity, which uses a beamformer to increase the SINR for a particular direction [6]-[10].

The first goal of this paper is to extend the works in [11] and [12] by considering multiple-cell system and closed-loop power control. In these works, a RAKE receiver in a single-cell system was proposed in the presence of frequency-selective Rayleigh fading channel, and perfect power control (PPC) was considered. Accordingly, in this paper, smart step closed-loop power control (SSPC) algorithm is proposed to compensate for near-far effects. This algorithm is a variable and smart step algorithm based on SINR measurement in base station [13], [14].

In this work, the performance analysis of direct-sequence (DS)-CDMA system in frequency-selective Rayleigh fading channel has been studied. If the delay spread in a multipath channel is larger than a fraction of a symbol, the delayed components will cause inter-symbol interference (ISI). Adaptive receiver beamforming schemes have been widely used to reduce both co-channel interference (CCI) and ISI and to decrease the bit error rate (BER) by adjusting the beam pattern such that the effective SINR at the output of the beamformer is optimally increased [15].

In this paper, a RAKE receiver in DS-CDMA system is analyzed in three stages according to Fig. 1 [11]. In the first stage, this receiver uses conjugate gradient (CG) adaptive beamforming to find optimum antenna weights assuming perfect estimation of the channel parameters (direction, delay, and power) for the desired user. The desired user resolvable paths' directions are fed to the CG beamformer to cancel out the CCI from other directions. Also, the RAKE receiver uses conventional demodulation in the second stage and conventional maximal ratio combining (MRC) in the third stage to reduce multiple-access interference (MAI). Reducing the MAI and the CCI will further decrease the system BER.

To improve the performance of cellular systems, base station assignment (BSA) technique can be used. In the joint power control and base station assignment, a number of base stations are potential receivers of a mobile transmitter. Accordingly, the objective is to determine the assignment of users to base stations which minimizes the allocated mobile powers. In simple mode and in multiple-cell systems, the user is connected to the nearest base station. This way is not optimal in cellular systems under the shadowing and multipath fading channels and can increase the system BER [16]-[19].

On the other hand, the second goal of this paper is to use base station assignment technique. In [18], the combined the base station assignment and power control was used to increase uplink capacity in cellular communication networks. In that work, it was shown that if there exists at least one feasible base station assignment, the proposed algorithm will find the jointly optimal base station assignment and power allocation in the sense that the transmitted power is minimized for

each mobile. In this work, we present the base station assignment based on minimizing the transmitter power (BSA-MTP) for achieving target BER in all cells [13], [20].

The organization of the remainder of this paper is as follows. The system model is presented in Section 2. The RAKE receiver structure is described in Section 3. In Section 4, we propose the SSPC algorithm. In Section 5, the BSA-MTP technique is presented. Section 6 describes switched-beam (SB) technique and equal sectoring (ES) method. Finally, simulation results and conclusions are given in Section 7 and Section 8, respectively.

2 System Model

In this paper, we focus on the uplink communication paths in a DS-CDMA cellular system. The channel is modeled as a frequency selective channel with Rayleigh distribution and lognormal distributed shadowing. Initially, we consider L paths for each link that optimally combined through a RAKE receiver according to Fig. 1. Also, we assume that there are M active base stations in the network, with K_m users connected to m th base station. At each base station, an antenna array of S sensors and N weights is employed, where $S = 2N - 1$, to receive signals from all users. Note that in CG adaptation algorithm, unlike other adaptation algorithms, the number of weights is less than the number of sensors. Also, for simplicity we assume a synchronous DS-CDMA scheme and BPSK modulation in order to simplify the analysis of proposed methods. Additionally, in this paper we assume a slow fading channel (the channel random parameters do not change significantly during the bit interval). Hence, the received signal in the base station q and sensor s from all users can be written as [11], [21]

$$r_{q,s}(t) = \sum_k \sqrt{p'_{k,m} \Gamma_k(x,y)} \sum_{l=1}^L \alpha_{k,m,l} b_{k,m}(t - \tau_{k,m,l}) \times c_{k,m}(t - \tau_{k,m,l}) \exp(-j2\pi sd \sin \theta_{k,m,l} / \lambda) + n(t) \quad (1)$$

where $c_{k,m}(t)$ is the pseudo noise (PN) chips of user k in cell m (user k,m) with a chip period of T_c ; $b_{k,m}(t)$ is the information bit sequence of user k,m with a bit period of $T_b = GT_c$ where G is processing gain; $\tau_{k,m,l}$ is the l -th path time delay for user k,m ; $\theta_{k,m,l}$ is the direction of arrival (DoA) in the l -th path for user k,m ; $\alpha_{k,m,l}$ is the complex Gaussian fading channel coefficient from the l th path of user k,m ; λ is signal wavelength; d is the distance between the antenna elements and $n(t)$ is an additive white Gaussian noise (AWGN) process with a two-sided power spectral density (PSD) of $N_0/2$. Also for conventional BSA

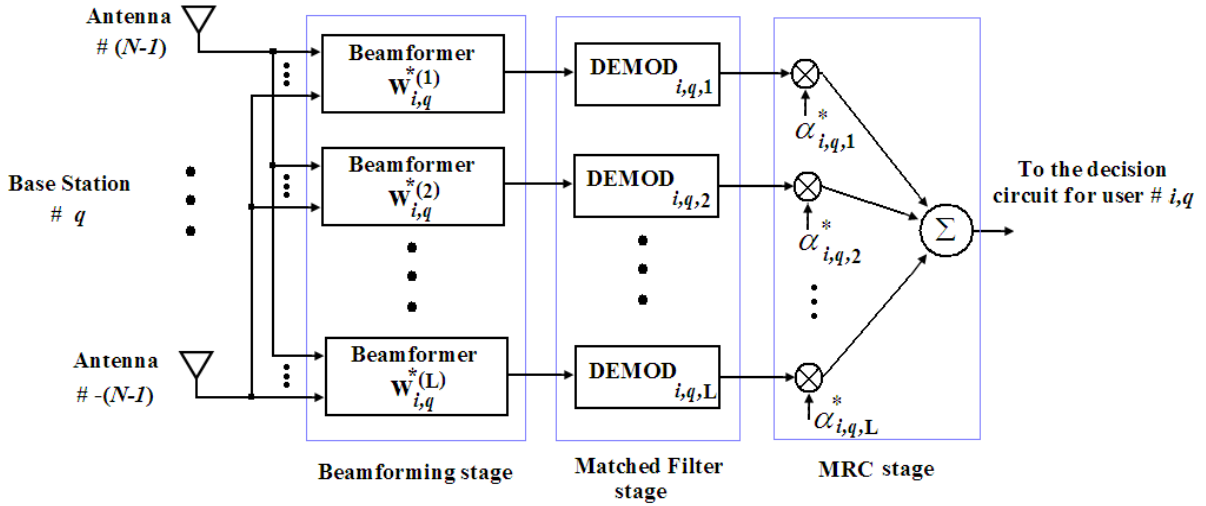

Fig. 1 Block diagram of a three-stage PAKE receiver in DS-CDMA system [11].

technique, $\Gamma_k(x, y)$ is defined as

$$\Gamma_k(x, y) = \begin{cases} 1 & ; k \in S_{BSq} \\ \frac{\min_{m \in \Theta_k} \{d_{k,m}^{L_\alpha}(x, y) 10^{\xi_{k,m}/10}\}}{d_{k,q}^{L_\alpha}(x, y) 10^{\xi_{k,q}/10}} & ; k \in S_o \end{cases} \quad (2)$$

where L_α is path-loss exponent; $d_{k,m}(x, y)$ and $d_{k,q}(x, y)$ are the distance between user k and BS m and BS q , respectively (see Fig. 2). Also the variable Θ_k defined the set of the nearest BSs to user k ; $\xi_{k,m}$ is a random variable modeling the shadowing between user k and BS m ; S_{BSq} is the set of users that connected to BS q and S_o is the set of users that not connected to BS q [2]. Also in Eq. (1):

$$p'_{k,m} = d_{k,m}^{-L_\alpha}(x, y) 10^{-\xi_{k,m}/10} \times p_{k,m} \quad (3)$$

is the received power in the BS m of user k, m in the presence of closed-loop power control where $p_{k,m}$ is the transmitted power of user k, m that in the case of the PPC, $p'_{k,m}$ is fixed for all users within cell m ($p'_{k,m} = E_b/T_b$ where E_b is the energy per bit for all users).

The received signal in the base station q in sensor s for user i, q is given by [11]

$$r'_{i,q,s}(t) = \sum_{l=1}^L \sqrt{p'_{i,q}} b_{i,q}(t - \tau_{i,q,l}) c_{i,q}(t - \tau_{i,q,l}) \times \alpha_{i,q,l} \exp(-j2\pi sd \sin \theta_{i,q,l} / \lambda) + I_{i,q,s}(t) + n(t) \quad (4)$$

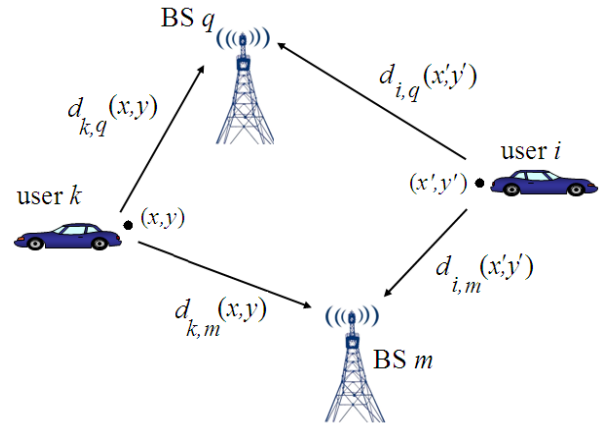

Fig. 2 The distance between two pairs of mobile transmitters and base station receivers [16].

where $I_{i,q,s}(t)$ is the interference for user i, q in sensor s and can be shown as

$$I_{i,q,s}(t) = \sum_{m=1}^M \sum_{\substack{k=1 \\ k, m \neq i, q}}^{K_m} \sum_{l=1}^L \sqrt{p'_{k,m} \Gamma_k(x, y)} b_{k,m}(t - \tau_{k,m,l}) \times c_{k,m}(t - \tau_{k,m,l}) \alpha_{k,m,l} \exp(-j2\pi sd \sin \theta_{k,m,l} / \lambda) \quad (5)$$

where K_m is the number of users in cell m and M is the number of base stations/cells.

3 RAKE Receiver Performance Analysis

The RAKE receiver structure in the DS-CDMA system is shown in Fig. 1. The received signal is spatially processed by a CG beamforming circuit, one for each resolvable path (L beamformers). The resultant signal is then passed on to a set of parallel matched filters (MFs), on a finger-by-finger basis. Also, the

output signals from the L matched filters are combined according to the conventional MRC principle and then are fed into the decision circuit of the desired user.

3.1 Conjugate Gradient Adaptive Beamforming

It is well known that an array of N weights has $N-1$ degree of freedom for adaptive beamforming. This means that with an array of N weights, one can generate $N-1$ pattern nulls and a beam maximum in desired directions. From Eq. (5), it is clear that the

number of users is $K_u = \sum_{m=1}^M K_m$ and the number of

interference signals is $LK_u - 1$. To null all of these interference signals; one would have to have LK_u weights, which is not practical. So, we focus only on the L paths of the desired user (inter-path interference). Thus, the minimum number of the antenna array weights is L where, typically, L varies from 2 to 6 [11], [21].

In this paper, we use the CG adaptive beamforming (CGBF) algorithm that is used of orthogonal principle [11], [12]. On this basis, a set of vectors \mathbf{w}_i is to select such that they are \mathbf{A} -orthogonal, i.e., $\langle \mathbf{A}\mathbf{w}_i, \mathbf{A}\mathbf{w}_j \rangle = 0$ for $i \neq j$. The optimum weights at time n are obtained by minimizing [11]

$$\|\mathbf{x}_{i,q}^{(j)}(n)\|^2 = \mathbf{x}_{i,q}^{H(j)}(n)\mathbf{x}_{i,q}^{(j)}(n) \quad (6)$$

where

$$\mathbf{x}_{i,q}^{(j)}(n) = \mathbf{A}_q \mathbf{w}_{i,q}^{(j)}(n) - \mathbf{y}_{i,q}^{(j)} \quad (7)$$

and

$$\mathbf{A}_q = \begin{bmatrix} r_{q,-(N-1)} & \cdots & r_{q,0} \\ \cdot & \cdot & \cdot \\ r_{q,0} & \cdots & r_{q,+(N-1)} \end{bmatrix} \quad (8)$$

is the $N \times N$ signal matrix in the base station q . Also,

$$\mathbf{y}_{i,q}^{(j)} = \left[e^{-j(N-1)\theta_{i,q,j}/2} \quad \dots \quad 1 \quad \dots \quad e^{+j(N-1)\theta_{i,q,j}/2} \right]^T \quad (9)$$

and

$$\mathbf{w}_{i,q}^{(j)}(n) = \left[w_{i,q,0}^{(j)}(n) \quad w_{i,q,1}^{(j)}(n) \quad \dots \quad w_{i,q,N-1}^{(j)}(n) \right]^T \quad (10)$$

are the excitation and weight vectors ($N \times 1$) for user i, q in the j th path, respectively.

It should be mentioned that CG algorithm has two main characteristics [11]:

- 1- This algorithm can produce a solution of the matrix equation very efficiently and converge in a finite number of iterations (the number of beamformer weights).
- 2- In CG algorithm, the convergence is guaranteed for any possible condition of the signal matrix, according to Eq. (8).

According to the method of CG, the updated value of the weight vector for user i, q in the j th path at time $n+1$ is computed by using the simple recursive relation [11], [12]:

$$\mathbf{w}_{i,q}^{(j)}(n+1) = \mathbf{w}_{i,q}^{(j)}(n) + \kappa_{i,q}^{(j)}(n) \boldsymbol{\beta}_{i,q}^{(j)}(n) \quad (11)$$

where

$$\begin{aligned} \kappa_{i,q}^{(j)}(n) &= \left\| \mathbf{A}_q^H \mathbf{x}_{i,q}^{(j)}(n) \right\|^2 / \left\| \mathbf{A}_q \boldsymbol{\beta}_{i,q}^{(j)}(n) \right\|^2 \\ \mathbf{x}_{i,q}^{(j)}(n+1) &= \mathbf{x}_{i,q}^{(j)}(n) + \kappa_{i,q}^{(j)}(n) \boldsymbol{\beta}_{i,q}^{(j)}(n) \\ \boldsymbol{\beta}_{i,q}^{(j)}(0) &= -\mathbf{A}_q^H \mathbf{x}_{i,q}^{(j)}(0) \\ \boldsymbol{\beta}_{i,q}^{(j)}(n+1) &= \mathbf{A}_q^H \mathbf{x}_{i,q}^{(j)}(n+1) + \eta_{i,q}^{(j)}(n) \boldsymbol{\beta}_{i,q}^{(j)}(n) \\ \eta_{i,q}^{(j)}(n) &= \left\| \mathbf{A}_q^H \mathbf{x}_{i,q}^{(j)}(n+1) \right\|^2 / \left\| \mathbf{A}_q^H \mathbf{x}_{i,q}^{(j)}(n) \right\|^2. \end{aligned} \quad (12)$$

The output signal from the j -th CG beamformer ($j = 1, \dots, L$) can be written as

$$\begin{aligned} y_{i,q}^{(j)}(t) &= \sqrt{p'_{i,q}} b_{i,q}(t - \tau_{i,q,j}) c_{i,q}(t - \tau_{i,q,j}) \alpha_{i,q,j} \\ &+ I_{i,q}^{(j)}(t) + n^{(j)}(t) \end{aligned} \quad (13)$$

where $n^{(j)}(t)$ is a zero mean Gaussian noise of variance σ_n^2 and $I_{i,q}^{(j)}(t)$, the MAI, is defined as

$$\begin{aligned} I_{i,q}^{(j)}(t) &= \sum_{m=1}^M \sum_{k=1}^{K_m} \sum_{l=1}^L \sqrt{p'_{k,m} \Gamma_k(x, y)} g_{i,q}^{(j)}(\theta_{k,m,l}) \\ &\times \alpha_{k,m,l} b_{k,m}(t - \tau_{k,m,l}) c_{k,m}(t - \tau_{k,m,l}) \end{aligned} \quad (14)$$

where

$$g_{i,q}^{(j)}(\theta) = \left[e^{-j(N-1)\theta/2} \quad \dots \quad 1 \quad \dots \quad e^{+j(N-1)\theta/2} \right] \times \mathbf{w}_{i,q}^{(j)} \quad (15)$$

is the magnitude response of the j th beamformer for user i, q toward the direction of arrival θ and $\mathbf{w}_{i,q}^{(j)}$ is the j -th beamformer's weight vector for user i, q .

3.2 Matched Filter

Using beamforming will only cancel out the inter-path interference for the desired user and will reduce the MAI from the users whose signals arrive at different angles from the desired user signal (out-beam

interference). Now, in the second stage of the RAKE receiver, the output signal from the j th beamformer is directly passes on to a filter matched to the desired user's signature sequence. The j th matched filter output corresponding to the n th bit is [11]:

$$z_{i,q}^{(j)}(n) = \sqrt{p'_{i,q}} b_{i,q}(n) \alpha_{i,q,j} + I'_{i,q}{}^{(j)}(n) + n'^{(j)}(n) \quad (16)$$

where

$$I'_{i,q}{}^{(j)}(n) = \frac{1}{T_b} \int_{(n-1)T_b + \tau_{i,q,j}}^{nT_b + \tau_{i,q,j}} I_{i,q}^{(j)}(t) c_{i,q}(t - \tau_{i,q,j}) dt \quad (17)$$

and

$$n'^{(j)}(n) = \frac{1}{T_b} \int_{(n-1)T_b + \tau_{i,q,j}}^{nT_b + \tau_{i,q,j}} n^{(j)}(t) c_{i,q}(t - \tau_{i,q,j}) dt. \quad (18)$$

If we assume that the paths' delays from all users are less than the symbol duration ($\tau_{k,m,l} < T_b$) for all users' signals on all paths, the n th bit MAI at the output of the j th matched filter can be expressed as

$$I'_{i,q}{}^{(j)}(n) = \sum_{m=1}^M \sum_{\substack{k=1 \\ k,m \neq i,q}}^{K_m} \sum_{l=1}^L \sqrt{p'_{k,m} \Gamma_k(x,y)} g_{i,q}^{(j)}(\theta_{k,m,l}) \times \alpha_{k,m,l} b_{k,m}(n) R_{i,k}(\tau_{i,q,j} - \tau_{k,m,l}) \quad (19)$$

where the autocorrelation function $R_{i,k}(\tau)$ is [11], [22]:

$$R_{i,k}(\tau) = \frac{1}{T_b} \int_{T_b} c_{i,q}(t) c_{k,m}(t + \tau) dt. \quad (20)$$

If all users' delays are multiples of the chip period (T_c), then

$$R_{i,k}(\tau) = \frac{1}{G} \sum_{l_1=0}^{G-1} \sum_{l_2=0}^{G-1} c_{i,q}(l_1) c_{k,m}(l_2) R_c(\tau - (l_1 - l_2)T_c) \quad (21)$$

where the autocorrelation function $R_c(\tau)$ is:

$$R_c(\tau) = \frac{1}{T_b} \int_{T_b} c(t) c(t + \tau) dt. \quad (22)$$

In the case of a maximal-length sequence (m-sequence) and for $0 \leq \tau \leq T_b$, we have [22]:

$$R_c(\tau) = \begin{cases} 1 - \frac{|\tau|}{T_c} (1 + 1/G) & ; |\tau| \leq T_c \\ -1/G & ; |\tau| \geq T_c \end{cases} \quad (23)$$

3.3 Maximal Ratio Combining

Diversity combining has been considered as an efficient way to combat multipath fading because the combined SINR is increased compared with the SINR of each diversity branch. The optimum combiner is the MRC whose SINR is the sum of the SINR's of each individual diversity branch [22], [23].

After the finger-matched filter, the fingers' signals are combined according to the MRC principle in the third stage of the RAKE receiver. In this paper, we use the conventional MRC that the signal of user i, q in the j th path is combined using multiplying by the complex conjugate of $\alpha_{i,q,j}$.

The SINR in output of the RAKE receiver for user i, q is [11], [23]:

$$\text{SINR}_{i,q}(\alpha) = \sum_{j=1}^L \text{SINR}_{i,q}^{(j)}(\alpha) \quad (24)$$

where

$$\text{SINR}_{i,q}^{(j)}(\alpha) = \frac{p'_{i,q} |\alpha_{i,q,j}|^2}{E(I'_{i,q}{}^{(j)})^2 + E(n'^{(j)})^2} \quad (25)$$

is the SINR in output of the RAKE receiver in path j for user i, q .

Also, we can be rewritten the SINR in Eq. (25) by Eq. (26), that shown at the bottom of the page, where $\bar{\Gamma}_k(x,y) = E(\Gamma_k(x,y))$ and $\bar{\alpha}_{k,m,j}^2 = E(|\alpha_{k,m,j}|^2)$ [11], [24].

In order to perform the BER, we assume Gaussian approximation for the probability density function of interference plus noise. The conditional BER for a BPSK modulation is [11], [22]:

$$\text{BER}_{i,q}(\alpha) = Q(\sqrt{2 \times \text{SINR}_{i,q}(\alpha)}) \quad (27)$$

where

$$Q(x) = \frac{1}{\sqrt{2\pi}} \int_x^{\infty} \exp(-u^2/2) du. \quad (28)$$

$$\text{SINR}_{i,q}^{(j)}(\alpha) = \frac{p'_{i,q} |\alpha_{i,q,j}|^2}{\sum_{m=1}^M \sum_{\substack{k=1 \\ k,m \neq i,q}}^{K_m} p'_{k,m} \bar{\Gamma}_k(x,y) \bar{\alpha}_{k,m,j}^2 \sum_{l=1}^L |g_{i,q}^{(j)}(\theta_{k,m,l})|^2 R_{i,k}^2(\tau_{i,q,j} - \tau_{k,m,l}) + \frac{N_0}{2T_b}} \quad (26)$$

4 Smart Step Closed-Loop Power Control Algorithm

A major limiting factor for the satisfactory performance of CDMA systems is the near-far effect. Power control is an intelligent way of adjusting the transmitted powers in cellular systems so that the total transmit power (TTP) is minimized, but at the same time, the user SINRs satisfies the system quality of service (QoS) requirements [25], [26].

Depending on the location where the decision on how to adjust the transmitted powers is made, the power control algorithm can be divided into two groups: centralized and distributed techniques [1]-[6], [16]. In centralized power control, a network center can simultaneously compute the optimal power levels for all users. However, it requires measurement of all the link gains and the communication overhead between a network center and base stations. Thus, it is difficult to realize in a large system [27]. Distributed power control, on the other hand, uses only local information to determine transmitter power levels. It is much more scalable than centralized power control. However, transmitter power levels may not be optimal, resulting in performance degradation [28], [29].

The distributed closed-loop power control problem has been investigated by many researchers from many perspectives during recent years [4], [25], [28]-[30]. For instance, the conventional fast closed-loop power control strategy used in practice in CDMA systems is a fixed step controller based on SINR measurements. The fixed step closed-loop power control (FSPC) algorithm is defined by [4]

$$p_{i,q}^{n'+1} = p_{i,q}^{n'} + \delta \text{sign}(\gamma_{i,q}^* - \gamma_{i,q}^{n'}) \quad (29)$$

where $p_{i,q}^{n'}$, $\gamma_{i,q}^*$, and $\gamma_{i,q}^{n'}$ are the transmitter power, SINR target, and measured SINR of user i, q at time n' , respectively, and δ is the fixed step size. Also $p_{i,q}^{n'+1}$ is transmitter power control (TPC) command in the feedback link of the base station to user i, q at time $n'+1$ (all signals are in decibels).

Also, the distributed traditional closed-loop power control (DTPC) is defined by [25]

$$p_{i,q}^{n'+1} = \frac{\gamma_{i,q}^*}{\gamma_{i,q}^{n'}} p_{i,q}^{n'}. \quad (30)$$

In both algorithms, the simple intuition behind this iteration is that if the current SINR $\gamma_{i,q}^{n'}$ of user i, q is less than the target SINR $\gamma_{i,q}^*$, then the power of that user is increased; otherwise, it is decreased.

It should be mentioned that convergence speed of DTPC algorithm is higher than FSPC algorithm. Also, the variance of the SINR mis-adjustment in FSPC algorithm is higher than DTPC algorithm. But, it has been shown that the FSPC algorithm converges to $|\gamma_{i,q}^* - \gamma_{i,q}^{n'}| \leq 2\delta k_d$, where k_d is the loop delay [4].

Also in [30], variable step closed-loop power control (VSPC) algorithm has been proposed. In this algorithm, variable step size is discrete with mode q_v . It is shown that the performance of VSPC algorithm with mode $q_v = 4$ is found to be worse than that of a fixed step algorithm ($q_v = 1$) under practical situations with loop delay of two power control intervals, but the convergence speed of VSPC algorithm is higher than FSPC algorithm. Also in this algorithm, the variance of the SINR mis-adjustment is reduced in compared to FSPC algorithm.

Practical implementations of power control in CDMA systems utilize closed-loop control, where the transmitter adjusts its power based on commands received from the receiver in a feedback channel. To minimize signaling overhead, typically one bit is used for the power control command. In practice, the command must be derived based on measurements made at the receiver, transmitted over the feedback channel to the transmitter, and finally processed and applied at the transmitter. All these operations constitute a loop delay, which can cause problems if it is not properly taken care of in the design of the power control algorithm. In many cases the loop delay is known due to a specific frame structure inherent in the system. A typical loop delay situation encountered in WCDMA systems is shown in Fig. 3. The slot at time $n't$ is transmitted using power $p^{n'}$. The receiver measures the SINR $\gamma^{n'}$ over a number of pilot and/or data symbols and derives a TPC command. The command is transmitted to the transmitter in the feedback link and the transmitter adjusts its power at time $(n'+1)t$ according to the command. It should be mentioned that since the power control signaling is standardized, the loop delays are known exactly [4].

In this paper, we propose the smart step closed-loop power control algorithm. We express the SSPC algorithm as follows [13], [14].

$$p_{i,q}^{n'+1} = p_{i,q}^{n'} + \delta |\gamma_{i,q}^* - \gamma_{i,q}^{n'}| \text{sign}(\gamma_{i,q}^* - \gamma_{i,q}^{n'}). \quad (31)$$

Performance of the SSPC algorithm is shown in Fig. 4.

Now, the algorithm is implemented as follows:

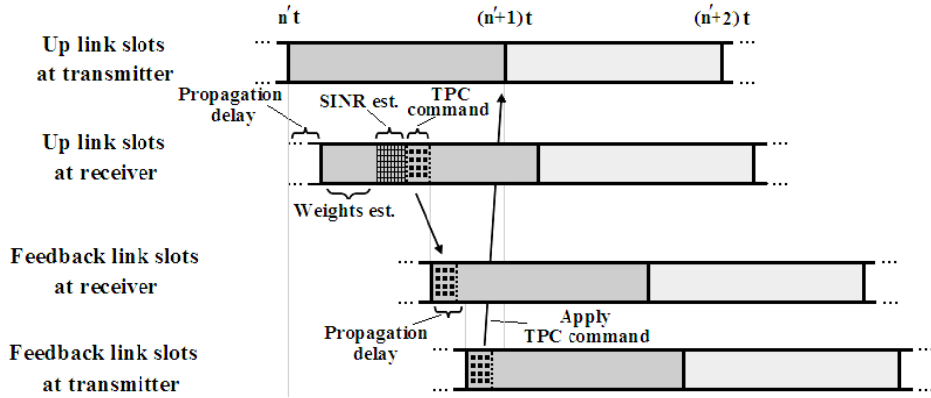

Fig. 3 Example of power control timing in WCDMA systems[4].

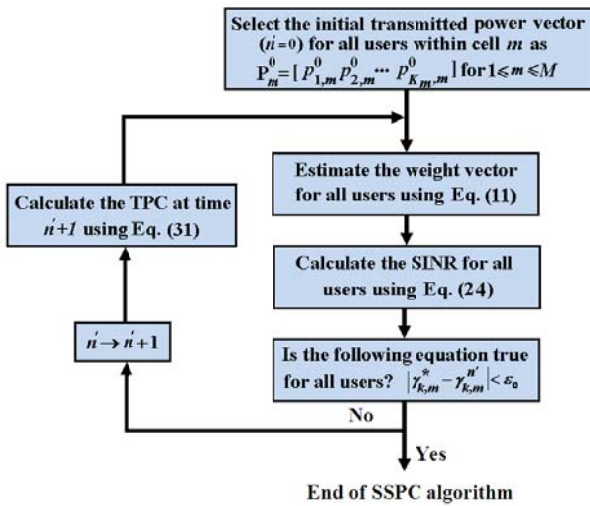

Fig. 4 Block diagram for SSPC algorithm.

- 1) Select the initial transmitted power vector ($n' = 0$) for all users within cell m as

$$\mathbf{p}_m^0 = [p_{1,m}^0, p_{2,m}^0, \dots, p_{K,m}^0], \quad m = 1, 2, \dots, M.$$

- 2) Estimate the weight vector for all users with the CG algorithm using Eq. (11).
- 3) Calculate the SINR for all users using Eq. (24).
- 4) If $|\gamma_{k,m}^* - \gamma_{k,m}^{n'}| > \epsilon_0$ for each user then set $n' = n' + 1$ and calculate the TPC for all users at time $n' + 1$ using Eq. (31) and go back to 2), where ϵ_0 is threshold value.
- 5) Finally, if $|\gamma_{k,m}^* - \gamma_{k,m}^{n'}| < \epsilon_0$ for all users then algorithm ends.

As will be seen from simulation results, because of variable coefficient in the sign function, the convergence speed of our algorithm is higher than FSPC and VSPC algorithms.

5 Base Station Assignment Based on Minimizing the Transmitter Power Technique

The system capacity might be improved, if the users are allowed to switch to alternative base stations, especially when there are congested areas in the network. Obviously, when uplink performance is of concern, the switching should happen based on the total interferences seen by the base stations [19].

So far, we have considered the power control problem for a number of transmitter-receiver pairs with fixed assignments, which can be used in uplink or downlink in mobile communication systems. In an uplink scenario where base stations are equipped with antenna arrays, the problem of joint power control and beamforming, as well as base station assignment, naturally arises.

In this paper, we modify the BSA-MTP technique to support base station assignment as well. The modified technique can be summarized as follows [13], [20].

- 1) Initially by the conventional BSA technique, each mobile connects to its base station, according to Eq. (2).
- 2) Estimate the weight vector for all users with the CG algorithm.
- 3) Each mobile updates its transmitted power based on the SSPC algorithm using Eq. (31).
- 4) Finally, $K_r = \lfloor K_u / M \rfloor$ users that their transmitted power is higher than the other users to be transferred to other base stations according to the following equation, where the function $\lfloor x \rfloor$ returns the integer portion of a number x .

$$\Gamma_k(x, y) = \begin{cases} 1 & ; k \in S_{BSq} \\ \frac{\min_{m \in \Theta_k} \left\{ d_{k,m}^{L_\alpha}(x, y) 10^{\xi_{k,m}/10} \right\}}{d_{k,q}^{L_\alpha}(x, y) 10^{\xi_{k,q}/10}} & ; k \in S_{BSq}^- \\ \frac{\min_{m \in \Theta_k} \left\{ d_{k,m}^{L_\alpha}(x, y) 10^{\xi_{k,m}/10} \right\}}{d_{k,q}^{L_\alpha}(x, y) 10^{\xi_{k,q}/10}} & ; k \in S_o \end{cases} \quad (32)$$

where S_{BSq}^- is the set of users that are in cell q but not connected to BS q [2].

It should be mentioned that the technique for users that are present in the border of cells, the BER can be effectively reduced.

6 Switched-Beam Technique and Equal Sectoring Method

One simple alternative to the fully adaptive antenna is the switched-beam architecture in which the best beam is chosen from a number of fixed steered beams. Switched-beam systems are technologically the simplest and can be implemented by using a number of fixed, independent, or directional antennas [31]. We list the conditions of the SB technique for this paper as follows.

- 1) According to Fig. 5, beams coverage angle is 30° and overlap between consecutive beams is 20° . Thus each base station has 36 beams.
- 2) According to Fig. 6, each user can use one beam for its each path to communicate with a base station at any time.

Also, one simple method to sectorize a cell is equal sectoring, in which all sectors have the same coverage angle. In this paper, we assume three sectors for each base station with sector angle 120° for the ES method [32].

7 Simulation Results

We consider $M = 4$ base stations for a four-cell CDMA system on a 2×2 grid as Fig. 7. We assume a uniform linear array of S omni-directional antennas in each base station with antenna spacing $d = \lambda/2$. Also, we assume the input data rate $T_b = 9.6$ Kbps; the number of antenna weights $N = 3$; the number of antenna sensors $S = 5$; threshold value $\varepsilon_0 = 0.1$ dB; frequency-selective fading channel with $L = 2$ resolvable propagation paths; variance of the complex Gaussian fading channel coefficient $\sigma_\alpha^2 = 4$ dB; fixed step size for SSPC, FSPC, and VSPC algorithms

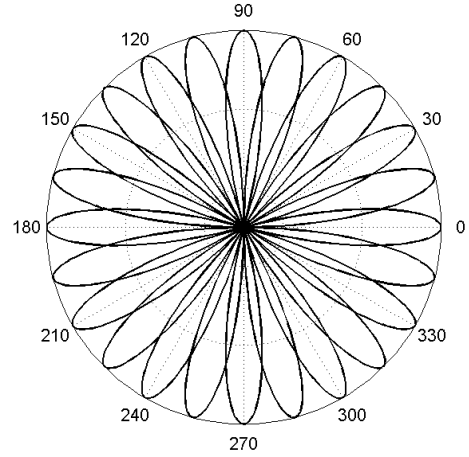

Fig. 5 36 beams in each base station with switched-beam technique.

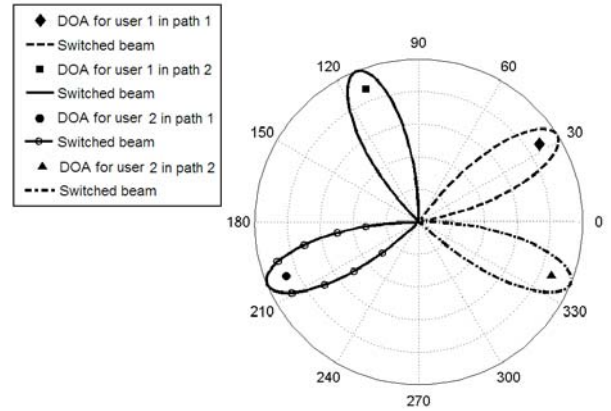

Fig. 6 Select of beam for two users in two paths with switched-beam technique.

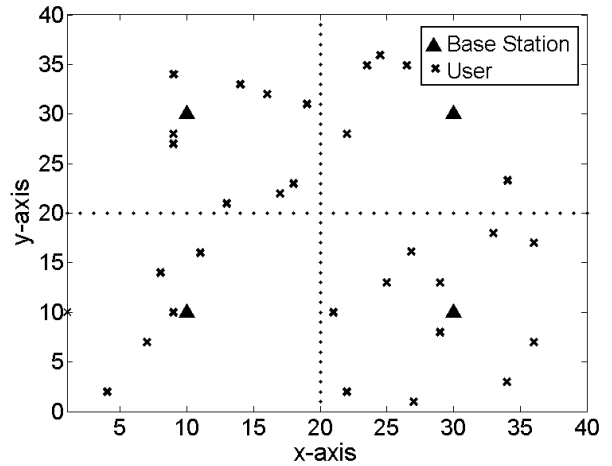

Fig. 7 Location plot of base stations and users in four cells.

$\delta = 0.01$; mode $q_v = 4$ for VSPC algorithm [30]; variance of the log-normal shadow fading $\sigma_\xi^2 = 8$ dB; path-loss component $L_\alpha = 4$; resolution $R = 1$; initial

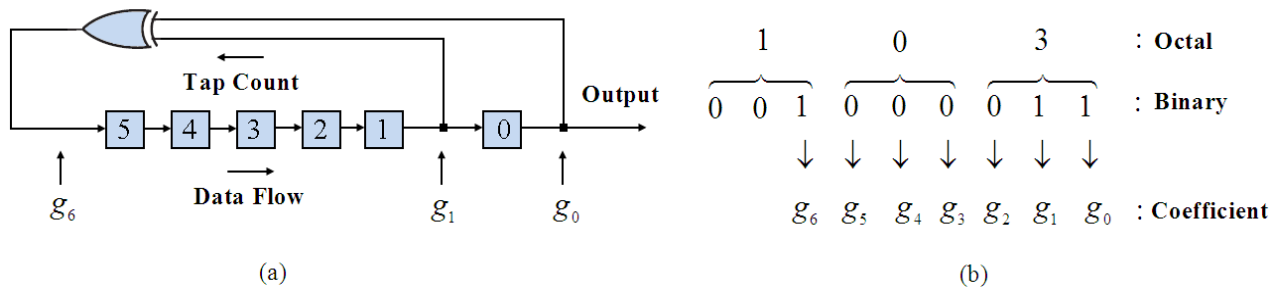

Fig. 8 (a) Fibonacci feedback generator for LFSR polynomial $g(D)=1+D+D^6$ for six-stage shift register (b) Expanding the octal entry 103 into binary form [22].

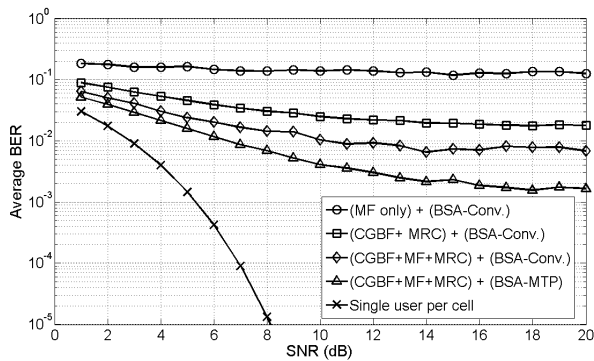

Fig. 9 Average BER of all users versus the SNR for the PPC case and $K_u = 32$.

value for weight vectors in CG algorithm $\mathbf{w}(0)=\mathbf{0}$; initial value for transmitted power vectors $\mathbf{p}_m^0 = \mathbf{0}$. The SINR target value is the same for all users and is set to $\gamma^* = 5(7\text{dB})$. It also is assumed that the distribution of users in all cells is uniform.

In this paper, we use m-sequence generator with processing gain $G = 64$ based on linear feedback shift register (LFSR) circuit using the Fibonacci feedback approach [22]. This structure is shown in Fig. 8 (a). Also, according to [22], we use the sequence generated by the polynomial corresponding to the entry the octal representation of generator polynomial, ORGP= [103]* for a six-stage shift register. Fig. 8 (b) shows expanding the octal entry 103 into binary form. Then, the LFSR polynomial is $g(D) = 1 + D + D^6$.

First, in order to compare the BSA-MTP and conventional BSA techniques, we assume the PPC, and the BER has been calculated from Eq. (27). Finally, we compare the TTP with the joint SSPC algorithm and BSA-MTP technique in comparison with other methods. Fig. 9 shows the average BER versus the signal-to-noise ratio (SNR) for different receivers (one, two, and three-stage receivers) in the case of $K_u = 32$ active users and the PPC case. It should be mentioned that in this simulation, $K_r = 8$ users can be transferred to other base stations with the BSA-MTP technique. It is clear

that, in MF only receiver (one-stage receiver) and in the case of the conventional BSA technique, we still have the error floor at high SNR. Using CGBF and MRC receiver (two-stage RAKE receiver) or CGBF, MF, and MRC receiver (the three-stage RAKE receiver as Fig. 1) has a better performance than using MF only. Also observe that using the BAS-MTP technique in the case of three-stage RAKE receiver, the average BER is lower than the conventional BSA technique. For example, at a SNR of 20dB, the average BER is 0.007 for the three-stage RAKE receiver with the conventional BSA technique, while for the BSA-MTP technique, the average BER is 0.0017. Also, it is clear that the MAI is not removed totally and the performance is still worse than the single user per cell bound.

Fig. 10 shows the average BER versus the number of active users (K_u) for different receivers as Fig. 9, in the case of the PPC and SNR = 10dB. At a BER of 0.01, the three-stage RAKE receiver with the BSA-MTP technique support $K_u = 52$ users, while for the three-stage RAKE receiver and the conventional BSA technique support $K_u = 30$ users. We also observe that the three-stage RAKE receiver can achieve lower BER than the other receivers. It should be mentioned that increasing the number of active users (K_u), will increase the number of users that can be transferred to other base stations (K_r) in the BSA-MTP technique.

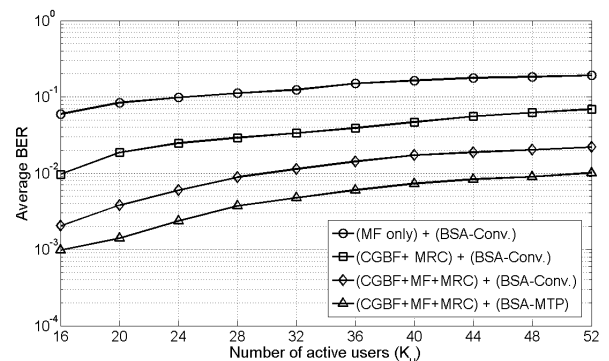

Fig. 10 Average BER for all users versus the number of active users (K_u) for the PPC case and SNR = 10dB .

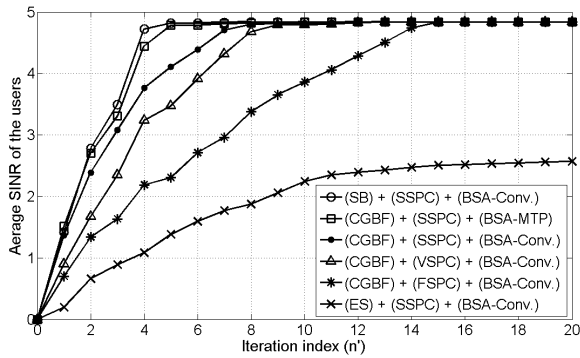

Fig. 11 Average SINR of all users versus power control iteration index (n'), with maximum power constraint of 1 W, $K_u = 32$, and SNR = 10dB .

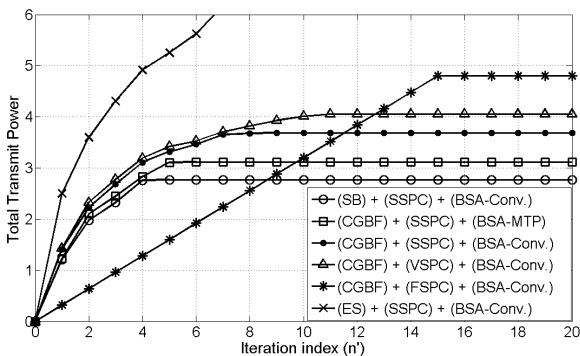

Fig. 12 Total transmit power of all users versus power control iteration index (n'), $K_u = 32$, and SNR = 10dB . No power constraints.

Fig. 11 shows the comparison of the average SINR achieved over $K_u = 32$ users versus the power control iteration index (n') for SSPC, VSPC, and FSPC algorithms and for BSA-MTP and conventional BSA techniques. In this simulation, the three-stage RAKE receiver uses CGBF, SB, or ES methods in the first stage. Also, we assume that each user to have a maximum power constraint of 1 watt. Accordingly, we observe that the convergence speed of the SSPC algorithm is faster than the VSPC and FSPC algorithms. The figure also shows that the SSPC algorithm with the BSA-MTP technique converges faster than the SSPC algorithm for the conventional BSA technique. In addition, we see that the convergence speed of the SSPC algorithm for the SB technique is faster than the CGBF and ES methods. Also observe that the average SINR level achieved is below the target SINR value for the ES method, because in this method the MAI is higher than CGBF and SB methods.

Fig. 12 shows the comparison of TTP usage versus the power control iteration index (n') when there are $K_u = 32$ users in all cells according to Fig. 11. But in this simulation, we assume that users no have maximum power constraints. Similar to Fig. 11, we observe that the ES method never can achieve the target SINR value.

Also this figure shows that the SSPC algorithm with the BSA-MTP technique offers more savings in the TTP as compared to the VSPC and FSPC algorithms for the conventional BSA technique. In addition, the figure shows that the TTP in BSA-MTP technique is less than conventional case. Also it can be seen that the TTP for the SB technique is lower than other methods, because in SB technique the MAI is lower than CGBF and ES methods.

8 Conclusions

In this paper, we studied the RAKE receiver performance of multiple-cell DS-CDMA system with the space diversity processing, Rayleigh frequency-selective channel model, closed-loop power control, and base station assignment. This receiver consists of CGBF, MF, and MRC in three stages.

Accordingly, we proposed the SSPC algorithm and the BSA-MTP technique to reduce the CCI and the MAI. It has been shown that, by using antenna arrays at the base stations, the SSPC algorithm and the BSA-MTP technique will decrease the interference in all cells. In addition, it can be seen that the TTP in the joint SSPC algorithm and BSA-MTP technique is less than the joint FSPC algorithm or VSPC algorithm and conventional BSA technique. Also our results show that the TTP for BSA-MTP technique is lower than conventional case. Thus, it decreases the BER by allowing the SINR targets for the users to be higher, or by increasing the number of users supportable at a fixed SINR target level. On the other hand, it has been shown that the convergence speed of the SSPC algorithm is increased in comparison with the VSPC and FSPC algorithms. It has also observed that using the BSA-MTP technique will decrease the average BER of the system to support a significantly larger number of users.

References

- [1] Abrardo A. and Sennati D., "On the analytical evaluation of closed-loop power-control error statistics in DS-CDMA cellular systems", *IEEE Transactions on Vehicular Technology*, Vol. 49, No. 6, pp. 2071-2080, Nov. 2000.
- [2] Carrasco L. and Femenias G., "Reverse link performance of a DS-CDMA system with both fast and slow power controlled users", *IEEE Transactions on Wireless Communications*, Vol. 7, No. 4, pp. 1255-1263, Apr. 2008.
- [3] Qian L. and Gajic Z., "Variance minimization stochastic power control in CDMA system", *IEEE Transactions on Wireless Communications*, Vol. 5, No. 1, pp. 193-202, Jan. 2006.
- [4] Rintamaki M., Koivo H. and Hartimo I., "Adaptive closed-loop power control algorithms for CDMA cellular communication systems", *IEEE Transactions on Vehicular Technology*, Vol. 53, No. 6, pp. 1756-1768, Nov. 2004.

- [5] Wang J. and Yu A., "Open-loop power control error in cellular CDMA overlay systems", *IEEE Journal on Selected Areas in Communications*, Vol. 19, No. 7, pp. 1246-1254, July 2001.
- [6] Wang J. T., "Admission control with distributed joint diversity and power control for wireless networks", *IEEE Transactions on Vehicular Technology*, Vol. 58, No. 1, pp. 409-419, Jan. 2009.
- [7] Dosararian-Moghadam M., Bakhshi H., Dadashzadeh G. and Rahmati P., "Adaptive beamforming method based on constrained LMS algorithm for tracking mobile user", *IEEE Global Mobile Congress*, Shanghai, China, Oct. 2009.
- [8] Kumatani K., McDonough J., Rauch B., Klakow D., Garner P. N. and Li W., "Beamforming with a maximum negentropy criterion", *IEEE Transactions on Audio, Speech, and Language Processing*, Vol. 17, No. 5, pp. 994-1008, July 2009.
- [9] Zhang R., Chai C. C. and Liang Y., "Joint beamforming and power control for multiantenna relay broadcast channel with QoS constraints", *IEEE Transactions on Signal Processing*, Vol. 57, No. 2, pp. 726-737, Feb. 2009.
- [10] Chang J., Tassiulas L. and Rashid-Farrokhi F., "Joint transmitter receiver diversity for efficient space division multiaccess", *IEEE Transactions on Wireless Communications*, Vol. 1, No. 1, pp. 16-27, Jan. 2002.
- [11] Mohamed N. A. and Dunham J. G., "A low-complexity combined antenna array and interference cancellation DS-CDMA receiver in multipath fading channels", *IEEE Journal on Selected Areas in Communications*, Vol. 20, No. 2, pp. 248-256, Feb. 2002.
- [12] Mohamed N. A. and Dunham J. G., "Adaptive beamforming for DS-CDMA using conjugate gradient algorithm in a multipath fading channel", in *Proc. 1999 IEEE Emerging Technologies Symp.*, Dallas, TX, pp. 859-863, Apr. 1999.
- [13] Dosararian-Moghadam M., Bakhshi H. and Dadashzadeh G., "Interference management for DS-CDMA systems through closed-loop power control, base station assignment and beamforming", *Journal of Wireless Sensor Network*, Vol. 2, No. 6, pp. 472-482, June 2010.
- [14] Dosararian-Moghadam M., Bakhshi H. and Dadashzadeh G., "Adaptive beamforming method based on closed-loop power control for DS-CDMA receiver in multipath fading channel", Accepted for publication in the 21th *IEEE Symposium on Personal, Indoor, and Mobile Radio Communications*, Istanbul, Turkey, Sep. 26-30, 2010.
- [15] Rashid-Farrokhi F., Ray-Liu K. J. and Tassiulas L., "Transmit beamforming and power control for cellular systems", *IEEE Journal on Selected Areas in Communications*, Vol. 16, No. 8, pp. 1437-1450, Oct. 1998.
- [16] Rashid-Farrokhi F., Tassiulas L. and Ray-Liu K. J., "Joint optimal power control and beamforming in wireless networks using antenna arrays", *IEEE Transactions on Communications*, Vol. 46, No. 10, pp. 1313-1324, Oct. 1998.
- [17] Yates R. D. and Huang C., "Integrated power control and base station assignment", *IEEE Transactions on Vehicular Technology*, Vol. 44, No. 3, pp. 638-644, Aug. 1995.
- [18] Hanly S. V., "An algorithm for combined cell-site selection and power control to maximize cellular spread spectrum capacity", *IEEE Journal on Selected Areas in Communications*, Vol. 13, No. 7, pp. 1332-1340, Sep. 1995.
- [19] Mahmoudi M. and Sousa E. S., "Joint power control, base station assignment and sectorization for CDMA cellular systems", in *Proc. 2000 IEEE Vehicular Technology Conference*, Boston, MA, Vol. 2, pp. 573-580, Sep. 24-28, 2000.
- [20] Dosararian-Moghadam M., Bakhshi H. and Dadashzadeh G., "Interference Management for DS-CDMA Receiver through Base Station Assignment in Multipath Fading Channels", in *Proc. 2010 IEEE International Conference on Wireless Communications, Networking and Information Security*, Beijing, China, June 2010.
- [21] Litva J. and Kwok-Yeung T., *Digital Beamforming in Wireless Communications*, chapter 2, Artech-House, 1996.
- [22] Peterson R. L., Ziemer R. E. and Borth D. E., *Spread-Spectrum Communications*, Prentice-Hall, 1995.
- [23] Kong N. and Milstein L. B., "Average SNR of a generalized diversity selection combining scheme", *IEEE Communications Letters*, Vol. 3, No. 3, pp. 57-59, Mar. 1999.
- [24] Liberti J. C. and Rappaport T. S., *Smart Antennas for Wireless Communications IS -95 and Third Generation CDMA Applications*, chapter 1, Prentice-Hall, 1999.
- [25] Yener A., Yates R. D. and Ulukus S., "Interference management for CDMA systems through power control, multiuser detection, and beamforming", *IEEE Transactions on Communications*, Vol. 49, No. 9, pp. 1227-1239, July 2001.
- [26] Kandukuri S. and Boyd S., "Optimal power control in interference-limited fading wireless channels with outage probability specifications", *IEEE Transactions on Wireless Communications*, Vol. 1, No. 1, pp. 46-55, Jan. 2002.
- [27] Grandhi S., Vijayan R. and Goodman D., "Centralized power control in cellular radio systems", *IEEE Transactions on Vehicular Technology*, Vol. 42, No. 4, pp. 466-468, Nov. 1993.

- [28] Zander J., "Distributed cochannel interference control in cellular radio systems", *IEEE Transactions on Vehicular Technology*, Vol. 41, No. 3, pp. 305-311, Aug. 1992.
- [29] Grandhi S., Vijayan R. and Goodman D., "Distributed power control in cellular radio systems", *IEEE Transactions on Communications*, Vol. 42, No. 2/3/4, pp. 226-228, Feb/Mar/Apr. 1994.
- [30] Kurniawan A., "Effect of feedback delay on fixed step and variable step power control algorithm in CDMA systems", in *Proc. 2002 IEEE International Conference on Communication Systems*, Singapore, Vol. 2, pp. 1096-1100, Nov. 2002.
- [31] Allen B. and Beach M., "On the analysis of switched-beam antennas for the W-CDMA downlink", *IEEE Transactions on Vehicular Technology*, Vol. 53, No. 3, pp. 569-578, May 2004.
- [32] Corazza G. E., De Maio G. and Vatalaro F., "CDMA cellular systems performance with fading, shadowing, and imperfect power control", *IEEE Transactions on Vehicular Technology*, Vol. 47, No. 2, pp. 450-459, May 1998.



Mohamad Dosaranian Moghadam was born in Tehran, Iran on May 26, 1979. He received the B.Sc. degree in electrical engineering from Islamic Azad University of Qazvin, Iran and the M.Sc. degree in communication engineering from Ferdowsi University, Mashad, Iran, in 2002 and 2005, respectively. He is currently working

toward the Ph.D degree in the Department of Electrical Engineering, Science and Research Branch of Islamic Azad University, Tehran, Iran. His research interests include power control, wireless communications, array and statistical signal processing, smart antennas, and adaptive filtering.



Hamidreza Bakhshi was born in Tehran, Iran on April 25, 1971. He received the B.Sc. degree in electrical engineering from Tehran University, Iran in 1992, the M.Sc. and Ph.D. degree in Electrical Engineering from Tarbiat Modarres University, Iran in 1995 and 2001, respectively. Since 2001, he has been as an Assistant Professor of

Electrical Engineering at Shahed University, Tehran, Iran. His research interests include wireless communications, multiuser detection, and smart antennas.



Gholamreza Dadashzadeh was born in Urmia, Iran, in 1964. He received the B.Sc. degree in communication engineering from Shiraz University, Shiraz, Iran in 1992 and M.Sc. and Ph.D. degree in communication engineering from Tarbiat Modarres University (TMU), Tehran, Iran, in 1996 and 2002, respectively. From

1998 to 2003, he has worked as head researcher of Smart Antenna for Mobile Communication Systems (SAMCS) and WLAN 802.11 project in radio communications group of Iran Telecomm Research Center (ITRC). From 2004 to 2008, he was dean of Communications Technology Institute (CTI) in ITRC. He is currently as Assistance Professor in the Department of Electrical Engineering at Shahed University, Tehran, Iran. He is a member of IEEE, Institute of Electronics, Information and Communication Engineers (IEICE) of Japan and Iranian Association of Electrical and Electronics Engineers (IAEEE) of Iran. He honored received the first degree of national researcher in 2007 from Iran's ministry of ICT. His research interests include antenna design and smart antennas.