

Discrimination of Inrush from Fault Currents in Power Transformers Based on Equivalent Instantaneous Inductance Technique Coupled with Finite Element Method

M. Jamali*, M. Mirzaie* and S. A. Gholamian*

Abstract: The phenomenon of magnetizing inrush is a transient condition, which occurs primarily, when a transformer is energized. The magnitude of inrush current may be as high as ten times or more times of transformer rated current that causes malfunction of protection system. So, for safe running of a transformer, it is necessary to distinguish inrush current from fault currents. In this paper, an equivalent instantaneous inductance (EII) technique is used to discriminate inrush current from fault currents. For this purpose, a three-phase power transformer has been simulated in Maxwell software that is based on finite elements. This three-phase power transformer has been used to simulate different conditions. Then, the results have been used as inputs in MATLAB program to implement the equivalent instantaneous inductance technique. The results show that in the case of inrush current, the equivalent instantaneous inductance has a drastic variation, while it is almost constant in the cases of fault conditions.

Keywords: Equivalent Instantaneous Inductance, Finite Element, Inrush Current.

1 Introduction

Power transformers are a class of very expensive and vital component of electric power systems. The cost associated with unplanned outage of a power transformer is very high. So, it is important to minimize the frequency and duration of unwanted outages in this component. One of the main reasons for wrong operation of protective system for the transformer is inrush current. Inrush current is a transient current that occurs in a transformer due to flux saturation in the core and its magnitude can be as high as fault currents. Because inrush current is not a fault current, it is important to develop a technique to distinguish this current from fault currents. In this regard, some techniques have been proposed in the literature. Since a magnetizing inrush current generally contains a larger second harmonic component, [1] used second harmonic criteria to distinguish inrush current from fault currents. Also, for improving the second harmonic restraint algorithm, in [2] instead of measuring the ratio between the magnitudes of the second and fundamental harmonic

components, a ratio between the phasors of them has been used. In [3-4], discrimination of inrush current from fault currents have been investigated based on wavelet transform. In this technique, the wavelet transform is implemented on the differential currents and inrush current is distinguished from fault currents based on different features of their wavelet components. Identification of inrush current in transformer using error estimation technique is discussed in [5]. Based on error estimation technique, first, the dead angles are extracted from the differential current waves. Then, with comparing this wave with two reference waves, inrush current can be discriminated from fault currents. In [6], inrush current is discriminated from fault currents by calculating the average of the active power flowing into transformers from each terminal. In [7], by examination of the main flux variation that is constructed by the voltages and currents of transformer windings, inrush current is identified. In [8-9], using S transform, different features are extracted for inrush current and fault currents. For discrimination of inrush current from fault currents, improved correlation algorithm is used in [10]. In this technique, by examination of correlation coefficients between two successive half cycles, inrush current can be distinguished from fault currents.

In this paper, an equivalent instantaneous inductance technique (EII) is used for discrimination of inrush

Iranian Journal of Electrical & Electronic Engineering, 2011.

Paper first received 23 Nov. 2010 and in revised form 30 Apr. 2011.

* The Authors are with the Department of Electrical and Computer Engineering, Babol University of Technology, P. O. Box 484, Babol, Iran.

E-mails: m.jamali@stu.nit.ac.ir, mirzaie@nit.ac.ir and gholamian@nit.ac.ir.

current from fault currents. First, some formulas based on transformer equivalent circuit have been derived. Then, for verifying these formulas on a typical transformer, a three-phase power transformer has been simulated in Maxwell software together with Simplorer software for investigation of different situations. Finally, a MATLAB program based on derived formulas has been written to check the validity of the formulas.

2 Equivalent Instantaneous Inductance Technique

The differential equation in the primary side of a two-winding transformer can be expressed as follow:

$$v_1(t) = R_1 i_1(t) + L_1 \frac{di_1(t)}{dt} + \frac{d\lambda(t)}{di_m(t)} \cdot \frac{di_m(t)}{dt} \quad (1)$$

where, $v_1(t)$, L_1 , R_1 and $i_1(t)$ are the terminal voltage, leakage inductance, resistance and current in the primary winding, respectively. Also, $\lambda(t)$ and $i_m(t)$ are the flux linkage and magnetizing current, respectively. It should be noted that the voltage drop of the magnetizing branch of transformer core in equation (1) has been considered as follow:

$$v_m(t) = \frac{d\lambda(t)}{dt} = \frac{d\lambda(t)}{di_m(t)} \cdot \frac{di_m(t)}{dt} \quad (2)$$

If L_m is defined as equation (3), then it represents the instantaneous magnetizing inductance of transformer.

$$L_m = \frac{d\lambda(t)}{di_m(t)} \quad (3)$$

In the normal and internal fault conditions of transformer, the core is not saturated and the magnetizing current is very little. These situations result in constant instantaneous magnetizing inductance that has very small variations. However, the inrush current is result of the transformer core saturation. Because in the inrush situation, the transformer core will alternate between the saturation and normal conditions, the instantaneous magnetizing inductance has vast variations. This situation is shown in Fig. 1 where, L_{norm} and L_{sat} represent the magnetizing inductance in the normal and highly saturated conditions, respectively.

As it can be concluded, the calculation of the instantaneous magnetizing inductance is very difficult, because it depends on the accurate flux linkage in the transformer core. For overcoming this problem, the EII can be defined as a solution. For this purpose, Fig. 2 that shows the general form of the equivalent circuit for a two-winding transformer can be considered. In this model the parameters of the secondary side have been converted to the primary side by the transformation ratio. Also, it should be mentioned that L_s is the leakage inductance in the short-circuit winding, where $L_s = \infty$ corresponds to the normal operation.

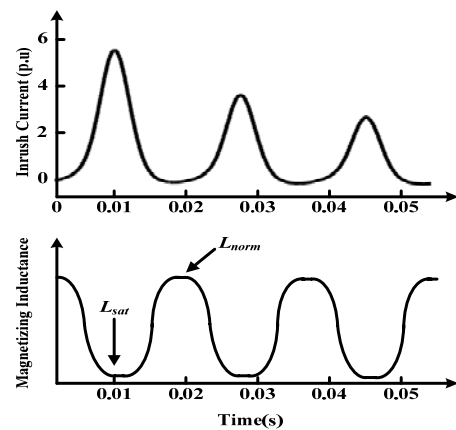

Fig. 1 Variation of magnetizing inductance during the inrush current.

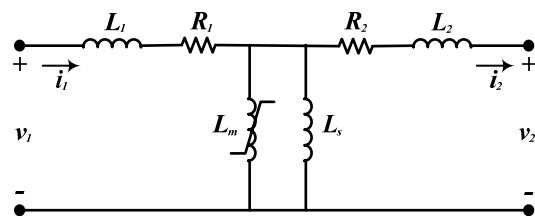

Fig. 2 General equivalent circuit for two-winding transformer.

For the equivalent circuit shown in the Fig. 2, the following equation can be written in the primary side:

$$v_1(t) = R_1 \Delta i(t) + L_e \frac{d\Delta i(t)}{dt} + R_1 i_2(t) + L_1 \frac{di_2(t)}{dt} \quad (4)$$

where $\Delta i(t)$ and L_e are defined as follows:

$$\Delta i(t) = i_1(t) - i_2(t) \quad (5)$$

$$L_e = L_1 + \frac{L_m L_s}{L_m + L_s} \quad (6)$$

L_e is defined as the EII that is a nonlinear function of L_m with constant L_1 and L_s . As it can be concluded, L_e will be constant during internal fault and normal conditions, but it will have a drastic variation when an inrush current occurs. Therefore, the EII (L_e) has an equivalent characteristic to the instantaneous magnetizing inductance (L_m) and can be used as a criterion for discrimination inrush current from fault currents. The calculation of L_e can be done using the parameters of transformer and measured instantaneous currents and voltages of the primary and secondary sides. Because obtaining the accurate values of the transformer parameters is difficult, it is necessary to consider an approximation to simplify the procedure of the calculation of L_e . For this purpose, because the voltage drop of the secondary winding load current in L_1 and R_1 is negligible when comparing with that of the differential current in the R_1 and L_e , especially for large-scale transformers, the third and fourth term on the right

side of the equation (4) can be eliminated and written as follow:

$$v_1(t) = R_1 \Delta i(t) + L_e \frac{d\Delta i(t)}{dt} \quad (7)$$

Equation (7) has been transformed into a discrete difference equation form using trapezoid principle. At kT instant, this equation is as follow:

$$v_1(k) = R_1 \Delta i(k) + L_e \frac{\Delta i(k+1) - \Delta i(k-1)}{2T} \quad (8)$$

where, T is the sampling cycle. For eliminating R_1 in equation (8), equation (7) has been written at $(k-1)T$ instant and this equation together with equation (8) have been used for calculation of the equivalent instantaneous inductance at kT instant as follow:

$$L_e = 2T[v_1(k)\Delta i(k-1) - v_1(k-1)\Delta i(k)] / [\Delta i(k+1)\Delta i(k-1) + \Delta i(k)\Delta i(k-2) - \Delta i^2(k) - \Delta i^2(k-1)] \quad (9)$$

Also, it should be noted that the variation of the EII has been calculated using following equations.

$$\Delta \bar{L}_e = \sqrt{\frac{1}{N} \sum_{i=1}^N [L_e(i) - \bar{L}_e]^2} \quad (10)$$

$$\bar{L}_e = \frac{1}{N} \sum_{i=1}^N L_e(i) \quad (11)$$

where, N is the number of samples per power frequency cycle. $\Delta \bar{L}_e$ is used to discriminate inrush current from the fault current based on the following criterion: If $\Delta \bar{L}_e$ exceeds a threshold, then there is an inrush current, otherwise fault situation has been occurred.

3 Simulation Results

In order to verify the validity of the mentioned method in the discrimination of inrush current from fault currents, a three-phase power transformer has been simulated in Maxwell software that is based on finite element method (FEM). The FEM is a rapid and effective way in simulation and modeling of advanced engineering systems that solve a problem by dividing the problem domain into several elements and then applying physical laws to each small element [11-12]. Also, Simplorer software has been used to create transformer connections and different situations including magnetizing inrush and fault conditions. The parameters of the simulated transformer are given in Table 1.

It should be mentioned that the analysis has been investigated on the lower tap that is including HV1. Fig. 3 shows this three-phase power transformer in the Maxwell environment. Also, some geometry of the

employed transformer with 2D representation is drawn in Fig. 4.

The magnetization curve of transformer core is shown in Fig. 5. This curve has been assigned to the material that is used for modeling the nonlinear nature of transformer core.

It should be noted that a 2 kHz sampling frequency has been used to obtain data from different conditions. Then, the obtained data have been transferred to the MATLAB software. In this software, a program based on equations (9-11) has been written to obtain EII in

Table 1 Parameters of the simulated transformer.

Transformer connection	Δ/Y (LV/HV)
Rated apparent power	30 MVA
Voltage ratio	20/63 kV
Rated frequency	50 Hz
Number of LV turn (each limb)	232
Number of HV1 turn (each limb)	352
Number of HV2 turn (each limb)	70
Number of HV3 turn (each limb)	63
Core steel type	M5

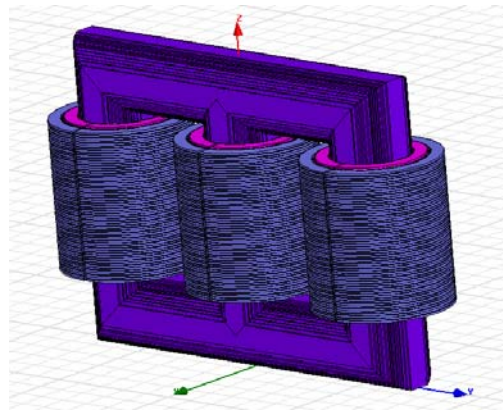

Fig. 3 Simulated transformer in Maxwell environment.

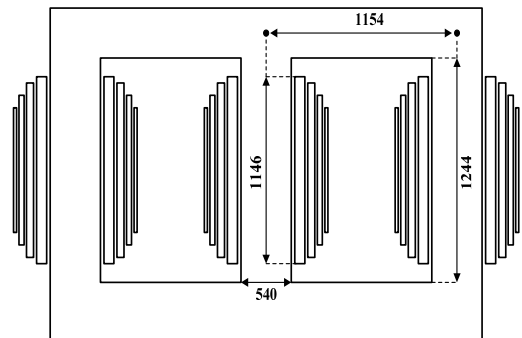

Fig. 4 Primitive geometry of the simulated transformer in Table 1 (dimensions are in mm).

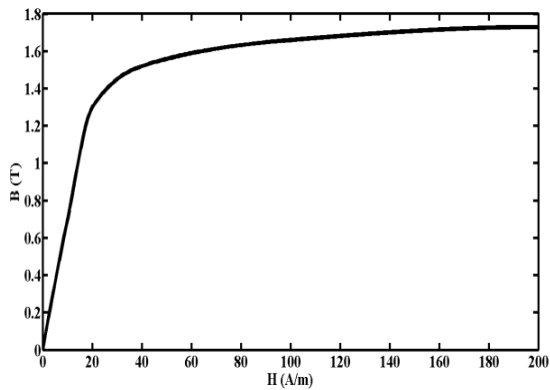

Fig. 5 Magnetization curve of the modeled transformer.

different cases. The following sections present the results of the above mentioned procedure.

3.1 Magnetizing Inrush Situation

In this case, the inrush phenomenon is created through the connection of no load power transformer to the power source in zero time. The inrush amplitude in this situation for the three-phase power transformer is shown in Fig. 6. As seen from the figure, all phases have shown inrush current situation that should be analyzed with EII criterion.

Figure 7 shows the variation of the EII for three phases of transformer. As seen from the figure, EII for all phases show a drastic variation with high amplitude, which is the key feature of the inrush current.

3.2 Internal Short Circuit Fault

For the simulation of internal fault, two cases have been considered. The first one is the turn-turn short circuit and the second is the turn-ground short circuit.

3.2.1 Turn-Turn Short Circuit

In this case, a short circuit of 30 turns in the phase C for the on load situation of transformer has been considered. Fig. 8 shows the differential currents of all phases in this situation.

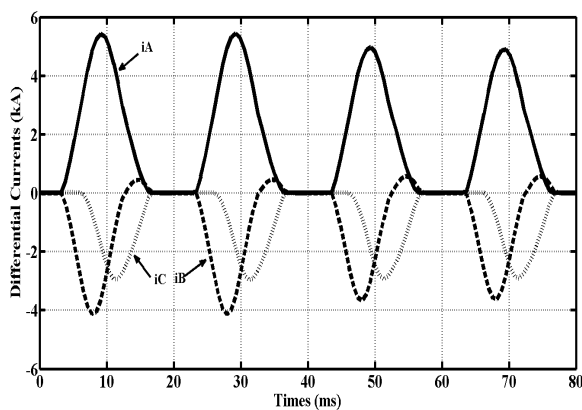
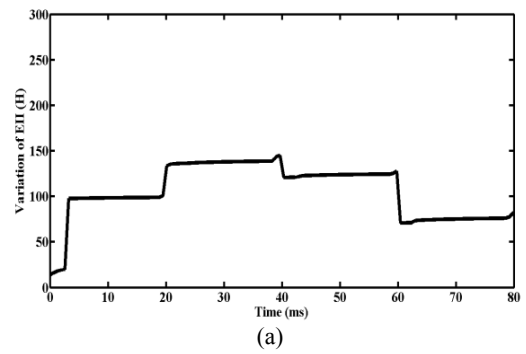
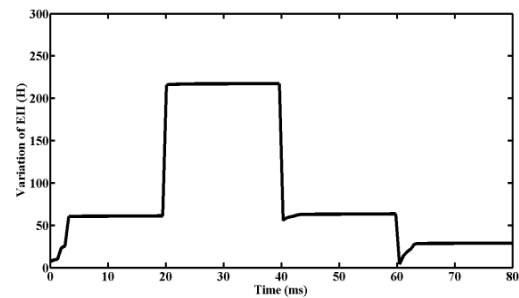

Fig. 6 Inrush current for all three phases.



(a)



(b)

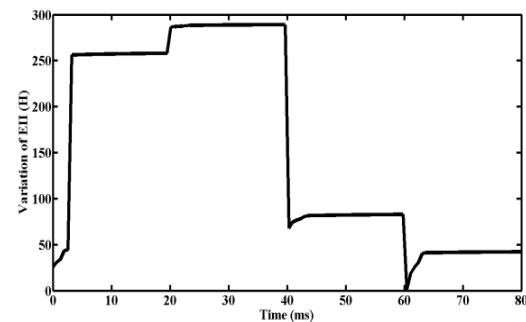

(c)

Fig. 7 Variation of EII in the case of inrush current (a) phase A (b) phase B (c) phase C.

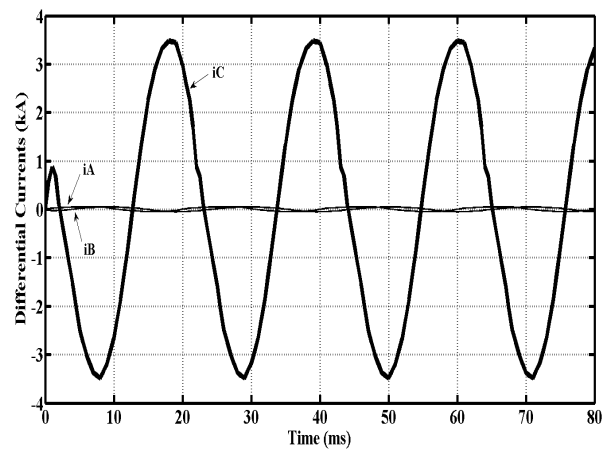

Fig. 8 Differential currents when the short circuit of 30 turns occurs in the phase C.

As seen from Fig. 8, the differential currents of A and B phases are within the range of nominal magnetizing current, but C phase current is larger than the nominal magnetizing current. Therefore, it is necessary to calculate EII for C phase. As seen from the Fig. 9, the calculated EII for C phase shows a small variation which corresponds to the mentioned criterion.

3.2.2 Turn-Ground Short Circuit

In this case, a turn-ground short circuit in phase B has been considered. Fig. 10 shows the differential currents of all phases in this situation. As seen from Fig. 10, the differential current of B phase is larger than the nominal magnetizing current, while the differential currents of other phases are in normal range. Therefore, it is necessary to verify B phase with the mentioned method.

Figure 11 shows the calculated EII for B. As it can be concluded from this figure, a small variation in EII of B phase corresponds to the mentioned criterion for fault situations. So, similar to previous case, the fault situation can be characterized with small variation in EII.

3.3 Single Line to Ground Fault

In this case, a single line to ground (phase A) occurred on the secondary side with a balanced Y connected of phase connected to the secondary side.

Figure 12 shows the three differential currents. In this situation, the differential current of phase A is larger than the nominal. Therefore, the phase A must be analyzed with EII criterion. Fig. 13 shows the calculated EII for phase A. As seen in this figure, from the small variation of EII, it can be concluded that the fault situation has been occurred and the relay must operate.

As it can be concluded from the EII figures for different situations including inrush and fault conditions, the variation of EII for fault situations are very small (at most 0.02), while it is high for inrush situation (at least 50), so a safe threshold between these two numbers can be selected for discrimination purpose.

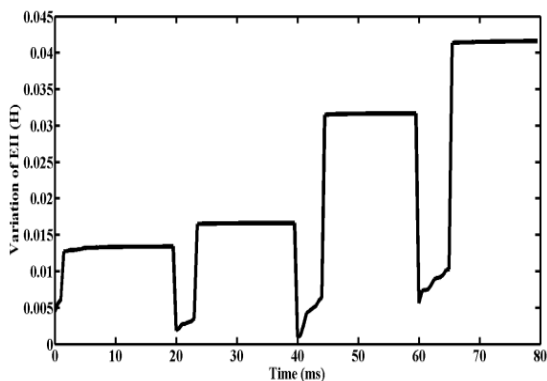

Fig. 9 Variation of EII of phase C in the case of turn-turn short circuit.

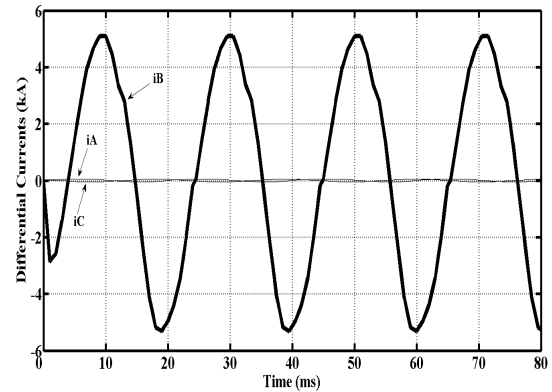

Fig. 10 Differential currents in the case of turn-ground short circuit in the phase B.

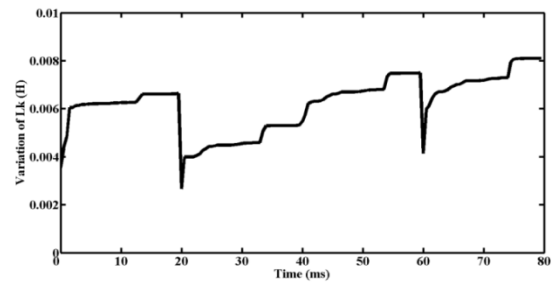

Fig. 11 Variation of EII of phase B in the case of turn-ground short circuit.

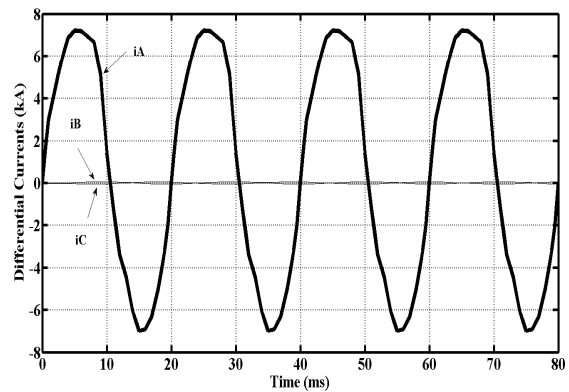

Fig. 12 Differential currents in the case of single line to ground fault in phase A.

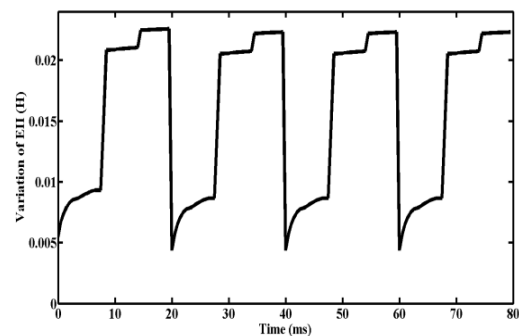

Fig. 13 Variation of EII of phase A in the case of single line to ground fault.

4 Conclusion

In this paper, an equivalent instantaneous inductance (EII) technique has been used to discriminate inrush current from fault currents. This method is based on different behaviors of the calculated EII for inrush current and fault currents. The calculated EII during inrush current has a drastic variation, while it is almost constant during fault conditions. For checking the validity of the EII technique in the discrimination of inrush current from fault currents, a three phase power transformer has been simulated in Maxwell software that is based on finite element method. The obtained data of different situations have been implemented on EII technique. The results show a good performance of the technique in the discrimination of inrush current from fault currents.

References

- [1] Sykes J. A. and Morrison I. F., "A proposed method of harmonic restraint differential protecting of transformers by digital computer", *IEEE Trans. Power Apparatus and Systems*, Vol. PAS-91, pp. 1266-1272, May 1972.
- [2] Kasztenny B. and Kulidjian A., "An improved transformer inrush restraint algorithm increases security while maintaining fault response performance", *53rd Annual Conference for Protective Relay Engineers*, pp. 1-27, Apr. 2000.
- [3] Faiz J. and Lotfi-Fard S., "A novel Wavelet-based algorithm for discrimination of internal faults from magnetizing inrush currents in power transformers", *IEEE Trans. Power Del.*, Vol. 21, No. 4, pp. 1989-1996, Oct. 2006.
- [4] Youssef O. A. S., "A wavelet-based technique for discrimination between faults and magnetizing inrush currents in transformers," *IEEE Trans. Power Del.*, Vol. 18, No. 1, pp. 170-176, Jan. 2003.
- [5] He B., Zhang X. and Bo Z. Q., "A new method to identify inrush current based on error estimation", *IEEE Trans. Power Del.*, Vol. 21, No. 3, pp. 1163-1168, July 2006.
- [6] Yabe K., "Power differential method for discrimination between fault and magnetizing inrush current in transformers", *IEEE Trans. Power Del.*, Vol. 12, No. 3, pp. 1109-1118, July 1997.
- [7] Zhao X., Chai J. and Su P., "Identification of magnetizing inrush currents of power transformers based on features of flux locus", *Sixth International Conference on Electrical Machines and Systems*, Vol. 1, No. 1, pp. 317-320, Nov. 2003.
- [8] Jiao S., Wang S. and Zheng G., "A new approach to identify current based on generalized S-transform", *International Conference on Electrical Machines and Systems*, pp. 4317-4322, Oct. 2008.

- [9] Zhang Q., Jiao S. and Wang S., "Identification inrush current and internal faults of transformer based on hyperbolic S-transform", *4th IEEE Conference on Industrial Electronics and Applications*, pp. 258-263, May 2009.
- [10] Ling X., Liu P. and Malik O. P., "Studies for identification of the inrush based on improved correlation algorithm", *IEEE Trans. Power Del.*, Vol. 17, No. 4, pp. 901-907, Oct. 2002.
- [11] Liu G. R. and Quek S. S., *The finite element method: A practical course*, Elsevier Science Ltd., 2003.
- [12] Faghihi F. and Heydari H., "Mathematical proof for the minimized stray fields in transformers using auxiliary windings based on state equations for evaluation of FEM results", *Iranian Journal of Electrical & Electronic Engineering*, Vol. 6, No. 1, pp. 62-69, Mar. 2010.



Morteza Jamali was born in Mahmoodabad, Iran, in 1984. He received the B.Sc. and M.Sc. degrees in electrical engineering from University of Tabriz, Tabriz, Iran in 2007 and University of Mazandaran, Mazandaran, Iran in 2011, respectively. His research interests include modeling and application of power transformers, finite-element modeling, and computer aided calculation of electromagnetic fields, electric machinery and high voltage engineering.



Mohammad Mirzaie was born in GhaemShahr, Iran in 1975. He Obtained B.Sc and M.Sc Degrees in Electrical Engineering from University of Shahid Chamran, Ahvaz, Iran and Iran University of Science and Technology, Tehran, Iran in 1997 and 2000 respectively and PhD Degree in Electrical Engineering from Iran University of Science and Technology in 2007. His research interests include high voltage engineering, intelligence networks for internal faults and studying of insulation systems in transformers, cables, generators, insulators, electrical motors.



Sayyed Asghar Gholamian was born in Babolsar, Iran, in 1976. He received B.Sc. degree in electrical engineering from K.N.Toosi University of Technology, Tehran, Iran in 1999 and M.Sc. degree in electric power engineering (electrical machines) from university of Mazandaran, Babol, Iran in 2001. He also received the Ph.D degree in electrical engineering from K.N.Toosi University of Technology, Tehran, Iran in 2008. He is currently an assistant professor in the department of Electrical Engineering at the Babol University of Technology, Iran. His research interests include power electronic and design, simulation, modeling and control of electrical machines.