

Load-Frequency Control: A GA Based Bayesian Networks Multi-Agent System

F. Daneshfar*, H. Bevrani* and F. Mansoori*

Abstract: Bayesian Networks (BN) provides a robust probabilistic method of reasoning under uncertainty. They have been successfully applied in a variety of real-world tasks but they have received little attention in the area of load-frequency control (LFC). In practice, LFC systems use proportional-integral controllers. However since these controllers are designed using a linear model, the nonlinearities of the system are not accounted for and they are incapable to gain good dynamical performance for a wide range of operating conditions in a multi-area power system. A strategy for solving this problem due to the distributed nature of a multi-area power system, is presented by using a BN multi-agent system. This method admits considerable flexibility in defining the control objective. Also BN provides a flexible means of representing and reasoning with probabilistic information. Efficient probabilistic inference algorithms in BN permit answering various probabilistic queries about the system. Moreover using multi-agent structure in the proposed model, realized parallel computation and leading to a high degree of scalability. To demonstrate the capability of the proposed control structure, we construct a BN on the basis of optimized data using genetic algorithm (GA) for LFC of a three-area power system with two scenarios.

Keywords: Load-Frequency Control, Multi-Agent System (MAS), Bayesian Network.

1 Introduction

Frequency changes in large scale power systems are a direct result of the imbalance between the electrical load and the power supplied by system connected generators [1]. Therefore load-frequency control is one of the important power system control problems which there has been continuing interest in designing LFCs with better performance using various methods during the last two decades [2-12].

For example, [11] and [12] have provided two different decentralized LFC synthesizes that, [11] proposed two robust decentralized control design methodologies for LFC. The first one is based on control design using linear matrix inequalities (LMI) technique and the second one is tuned by a robust control design algorithm. However, in [12], a decentralized LFC synthesis is formulated as an HN-control problem and is solved using an iterative LMI algorithm that gains lower order proportional-integral

(PI) controller than [11]. But all the above mentioned controllers are designed for a specific disturbance, if the nature of the disturbance varies, they may not perform as expected. Also they are model based controllers that are dependent to a specific model, and are not usable for large systems like power systems with nonlinearities, not defined parameters and model.

Therefore, design of intelligent controllers that are more adaptive than linear and robust controllers is become an appealing approach [13-16].

BN [17] is one of the adaptive and nonlinear control techniques that can be applicable in the LFC design. BNs are powerful tools for knowledge representation and inference under conditions of uncertainty that has been applied to a variety of power system problems [18-22]. It has been effectively used to incorporate expert knowledge and historical data for revising the prior belief in the light of new evidence in many fields. The main feature of the BN is that it is possible to include local conditional dependencies into the model, by directly specifying the causes that influence a given effect [20].

BNs can readily handle incomplete datasets and allow one to learn about causal relationships. It allows us to make predictions in the presence of interventions and in conjunction with Bayesian statistical techniques

Iranian Journal of Electrical & Electronic Engineering, 2011.

Paper first received 14 Nov. 2010 and in revised form 11 June 2011.

* The Authors are with the Department of Electrical and Computer Engineering, University of Kurdistan, Sanandaj, PO Box 416, Kurdistan, Iran.

Emails: daneshfar@ieeee.org,
Fathollah.mansoori@yahoo.com.

bevrani@ieeee.org,

facilitate the combination of domain knowledge and data. BN also offers an efficient and principled approach for avoiding the over fitting of data (there is no need to hold out some of the available data for testing), in another word using the Bayesian approach, models can be ‘smoothed’ in such a way that all available data can be used for training.

Moreover, as BNs are based on learning methods then they are independent of environment conditions and can learn each kind of environment disturbances, so they are not model based and can easily scalable for large scale systems. They can also work well in nonlinear conditions and nonlinear systems. A major advantage of BNs over many other types of predictive and learning models, such as neural networks, is that the BN structure represents the inter-relationships among the data set attributes then human experts can easily understand the network structures and if it is necessary modify them to obtain better predictive models.

In this paper, a Bayesian Networks multi-agent control structure is proposed. It has one agent in each control area that provides an appropriate control signal according to load disturbances and tie-line power changes received from other areas. This technique has been applied to the LFC problem in a three-control area power system as a case study. In the new environment, the overall power system can be considered as a collection of control areas interconnected through high voltage transmission lines or tie-lines. Each control area consists of a number of generating companies (Gencos) that is responsible for tracking its own load and performing the LFC task.

The organization of the rest of the paper is as follows. In Section 2, a brief introduction to BN and LFC problem is given. In Section 3, we explain how a load-frequency controller can be work within this formulation. In Section 4, a case study of three-control area power system which the above architecture is implemented for, is discussed. Simulation results are provided in Section 5 and paper is concluded in Section 6.

2 Backgrounds

Sequential data arises in many areas of science and engineering. The data may either be a time series, generated by a dynamical system, or a sequence generated by a 1-dimensional spatial process. In such problems, it is desirable to find the probability of future outcomes as a function of our inputs and the BN is a way to find that.

2.1 Graphical Models

Graphical models are a combination of probability theory and graph theory. The base idea of a graphical model is that a complex system is consisted of simpler parts [23]. Probability theory side of graphical model ensures that the system as a whole is consistent and providing ways to interface models to data, however the

graph theoretic side of it provides a way that humans can model highly-interacting sets of variables as well as a data structure that lends itself naturally to the design of general-purpose algorithms [23]. Actually a graphical model is a mathematical graph in that nodes are random variables, and arcs represent conditional independence assumptions between variables [23]. If there is no arc between two nodes, they are independent nodes else they are dependent variables.

There are two main kinds of graphical models: undirected and directed. Undirected graphical models are more popular with the vision communities however directed graphical models (BNs) are more popular with the artificial intelligence and machine learning communities [23]. In a directed graphical model an arc from node A to B can be informally interpreted that A “causes” B, (Which A is the parent node of B and B is the child node of A) [23].

2.2 Bayesian Networks

A BN is a graphical model that efficiently encodes the joint probability distribution for a large set of variables with relationships. Then they have become the standard methodology for the construction of systems relying on probabilistic knowledge and have been applied in a variety of real-worlds tasks [18].

A BN consists of (i) An acyclic graph S , (ii) A set of random variables $x = \{x_1, \dots, x_n\}$ (the graph nodes) and a set of arcs that determines the nodes (random variables) dependencies, and (iii) a conditional probability table (CPT) associated with each variable ($p(x_i | pa_i)$).

Together these components define the joint probability distribution for x . The nodes in S are in one-to-one correspondence with the variables x . In this structure, x_i denotes both the variables and its corresponding node, and pa_i denote the parents of node x_i in S as well as the variables corresponding to those parents. The lack of possible arcs in S encodes conditional independencies. In particular given structure S , the joint probability distribution for x is given by,

$$p(x_1, \dots, x_n) = \prod_{i=1}^n p(x_i | pa_i) \quad (1)$$

For example see a simple BN in Fig. 1 which nodes represent binary random variables. The event “grass is wet” ($W=\text{true}$) has two possible causes: either the water sprinkler is on ($S=\text{true}$) or it is raining ($R=\text{true}$). The strength of this relationship is shown in the table below W that is W 's CPT. For example, $P(W = \text{true} | S = \text{true}, R = \text{false}) = 0.9$ (second entry of second row), and hence, $P(W = \text{false} | S = \text{true}, R = \text{false}) = 1 - 0.9 = 0.1$, since each row must sum to one. Since the C node has no parents, its CPT specifies the prior probability that it is cloudy (in this case, 0.5) [23].

The basic tasks related to the BNs are:

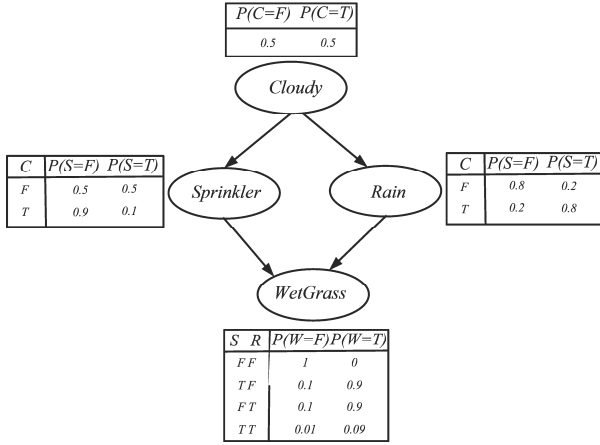

Fig. 1 A simple Bayesian network [23].

- Structure learning phase: finding the graphical model structure.
- Parameter learning phase: finding nodes probability distribution.
- Bayesian network inference.

The structure and parameter learning are based on the prior knowledge and prior data (training data) of the model. However the basic inference task of a BN consists of computing the posterior probability distribution on a set of query variables q , given the observation of another set of variables e called the evidence (i.e. $p(q|e)$). Different classes of algorithms have been developed that compute the marginal posterior probability $p(x|e)$ for each variable x , given the evidence e .

One of the important points in the BNs is that it doesn't need to learn the inference data. Inference is a probabilistic action that obtains the probability of the query using prior probability distribution.

2.3 Load Frequency Control

A large-scale power system consists of a number of interconnected control areas [24]. Fig. 2 shows the block diagram of control area- i , which includes n Gencos, from an N -control area power system. As is usual in the LFC design literature, three first-order transfer functions are used to model generators, turbine and power system (rotating mass and load) units. The parameters are described in the list of symbols in [24]. Following a load disturbance within a control area, the frequency of that area experiences a transient change, the feedback mechanism comes into play and generates appropriate rise/lower signal to the participating Gencos according to their participation factors (α_{ji}) to make generation follow the load. In the steady state, the generation is matched with the load, driving the tie-line power and frequency deviations to zero. The balance between connected control areas is achieved by detecting the frequency and tie-line power deviations to generate area control error (ACE) signal which is, in turn, utilized in the PI control strategy as shown in Fig.

2. The ACE for each control area can be expressed as a linear combination of tie-line power change and frequency deviation [24].

$$ACE_i = \beta_i \Delta f_i + \Delta P_{tie-i} \quad (2)$$

3 Proposed Control Framework

In practice, the LFC controller structure is traditionally a proportional-integral (PI)-type controller using the ACE as its input as shown in Fig. 2. In this section, the intelligent control design algorithm for such a load frequency controller using Bayesian networks multi-agent technique is presented.

Fig. 3 shows the proposed model for area i , that an intelligent controller have been used in this structure. It is responsible to find an appropriate supplementary control action.

The objective of the proposed design is to control the frequency to achieve the same performance as proposed robust control design in [11, 12].

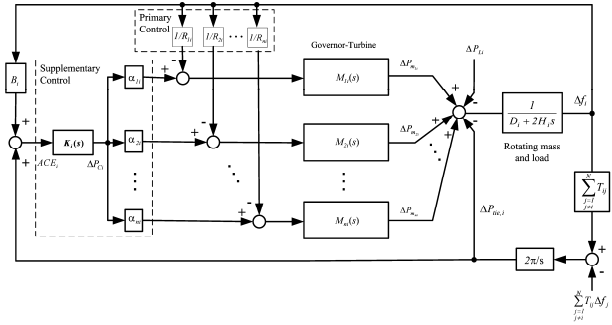

Fig. 2 LFC system with different generation units and participation factors in area i [24].

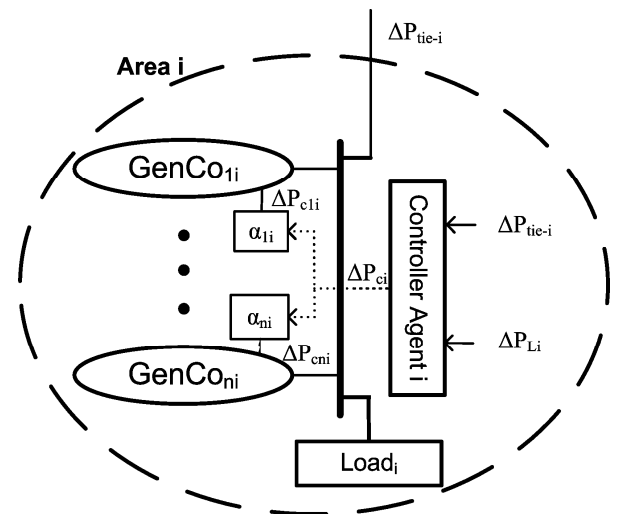

Fig. 3 The proposed model for area i .

3.1 BN Construction

To illustrate the process of a BN construction, it is better to start by determining of the necessary variables for modeling. This initial task is not always straightforward. As part of this task we must (i) correctly identify the goal of modeling, (ii) identify many possible observations that may be relevant to the problem, (iii) determine what subset of those observations is worthwhile to model, and (iv) organize the observations into variables having mutually exclusive and collectively exhaustive states.

In this algorithm, the aim is to achieve the conventional LFC objective and keep the ACE signal within a small band around zero using the supplementary control action signal (Fig. 2). Then the query variable in the posterior probability distribution is ΔP_c signal and the posterior probabilities according to possible observations relevant to the problem are as follows,

$$\begin{aligned}
 & p(\Delta P_c | ACE, \Delta P_{tie}, \Delta P_L, \Delta f) \\
 & p(\Delta P_c | ACE, \Delta P_L, \Delta f) \\
 & p(\Delta P_c | \Delta P_{tie}, \Delta P_L, \Delta f) \\
 & p(\Delta P_c | ACE, \Delta P_{tie}, \Delta P_L) \\
 & p(\Delta P_c | ACE, \Delta f) \\
 & p(\Delta P_c | \Delta P_{tie}, \Delta P_L) \\
 & \vdots \\
 & p(\Delta P_c | \Delta P_{tie}) \\
 & p(\Delta P_c | \Delta P_L)
 \end{aligned} \tag{3}$$

According to (3) there are so many observations that are related to this problem, however the best one that has the least dependency to the model parameters (e.g. frequency bias factor, etc) and causes the maximum effect on the frequency (speed) deviation and consequently ACE signal changes, are load disturbance and tie-line power deviation signals. Then the posterior probability that should be found is $p(\Delta P_c | \Delta P_{tie}, \Delta P_L)$.

3.2 Structure and Parameter Learning

After determining the most worthwhile subset of the observations ($\Delta P_{tie}, \Delta P_L$), in the next phase of Bayesian network construction, a directed acyclic graph that encodes assertion of conditional independence is built. It includes the problem random variables, nodes conditional probability distribution and nodes dependencies.

The basic structure of the graphical model is built based on the prior knowledge of the problem (see Fig. 4). In this algorithm, for the simplicity, the most important parameters are taken into account: load disturbances and tie-line power changes [24]. Therefore in this method it is considered that ΔP_c signal dependent to ΔP_L and ΔP_{tie} only, then finding the graphical model of Fig. 2 is very simple.

In the next step of BN construction (parameter

learning), the local conditional probability distribution(s) $p(x_i | pa_i)$ are computed from the training data. Probability distributions and conditional probability distribution related to this problem according to Fig. 4 are: $p(\Delta P_L)$, $p(\Delta P_{tie})$ and $p(\Delta P_c | \Delta P_L, \Delta P_{tie})$. To find the above probabilities, training data matrix should be in the format of Table 1. Bayesian networks toolbox (BNT) [25] uses the training data matrix and finds the conditional probabilities related to the graphical model variables (This is the parameter learning phase).

3.3 Bayesian Network Inferences

Once a BN has been constructed (from prior knowledge, data or a combination), various probabilities of interest from the model are determined. In this problem we want to compute the posterior probability distribution on a set of query variables, given the observation of another set of variables called the evidence. The posterior probability that should be found is $p(\Delta P_c | \Delta P_{tie}, \Delta P_L)$. This probability is not stored directly in the model, and hence needs to be computed. In general, the computation of a probability of interest given a model is known as probabilistic inference. Here BNT is used to probabilistic inference of the model.

3.4 Finding Training Data based on GA

As mentioned and is shown in the graphical model of a control area (Fig. 4), the essential parameters used for the learning phase among each control area are considered as ΔP_{tie} , ΔP_L , and ΔP_c .

Here genetic algorithm is used to find a related set of training data ($\Delta P_{tie}, \Delta P_L, \Delta P_c$) and to gain better results as follow.

GA produces a ΔP_c vector and the simulation is run (with the obtained ΔP_c) for a special load disturbance. Then the appropriate ΔP_c is evaluated based on the gained ACE signal.

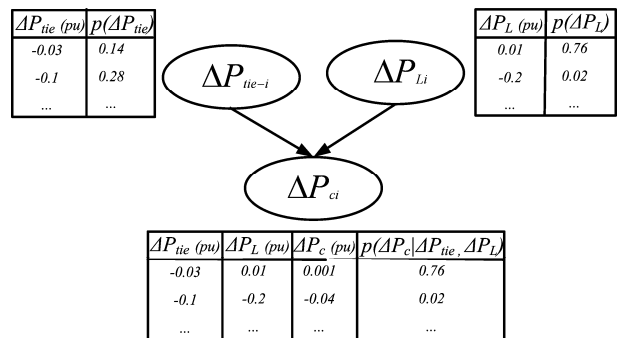

Fig. 4 The graphical model of area i.

Table 1 Training Data Matrix.

Time (sec)	ΔP_{tie} (pu)	ΔP_L (pu)	ΔP_c (pu)
1	0.03	0.1	-0.08
...

Each GA's individual (ΔP_c signal) is a double vector (population type) with 100 variables between [0 1] (the number of variables is equal to the simulation time). For simulation stage the vector values should be scaled to the valid ΔP_c changes of that area: $[\Delta P_{cMin} \Delta P_{cMax}]$. ΔP_{cMax} is the maximum power change that can be effected within one AGC cycle (it is automatically determined by the equipment constraints of the system) and ΔP_{cMin} is the minimum change that can be demanded in the generation.

The start population size is equal to 30 individuals and it was run for 100 generations. Fig. 5 shows the results of running the proposed GA for area 1 of the three-control area power system given in [11, 12].

To find individual's eligibility (fitness), ΔP_c values should be scaled to the according rang of that area (mentioned above). After scaling and finding the corresponding ΔP_c , the simulation is run for a special ΔP_L (a signal with 100 instances) and with above ΔP_c , for 100 seconds. The individual's fitness is proportional to the average distances of gained ACE signal instances from zero after 100 seconds simulation. Each individual that causes to smaller fitness is the best one and the tuple $(\Delta P_{tie}, \Delta P_L, \Delta P_c)$ related to that simulation is one row of the training data matrix.

This large training data matrix is partly complete and it can be used for parameter learning issue in the power system with a wide range of disturbances. Since, the BNs are based on inference and new cases (that may not include in the training set) can be inferred from the training data table, it is not necessary to repeat the learning phase of the system for different amounts of disturbances occurred in the system.

4 Case Study: A Three-Control Area Power System

As mentioned before, to illustrate the effectiveness of the proposed control strategy, a three-control area power system (same as example used in [11, 12]) is considered as a test system. It is assumed that each control area includes three Gencos and its parameters are given in [11, 12]. Then the proposed multi-agent structure for the three-control area power system is like Fig. 6. Our purpose here is essentially to show the various steps in implementation and illustrate the method.

After providing the training set according to Section 3, the training data related to each area are separately given to the BNT. The BNT uses the input data and do the parameter learning phase for each control area parameters. It finds prior and conditional probability distribution related to that area's parameters, which according to Fig. 4, are $p(\Delta P_L)$ and $p(\Delta P_{tie})$.

Following completing the learning phase, the power system simulation will be ready to run and the proposed model uses inference phase to find an appropriate control action signal (ΔP_c) of each control area as follows: At each simulation time step, corresponding controller agents of each area, get the input parameters

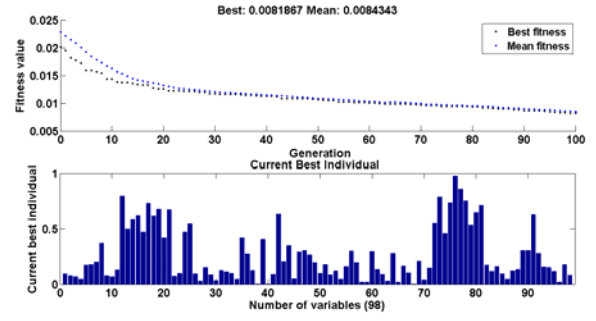

Fig. 5 The result of running GA for area 1 of the three-control area power system given in [11, 12].

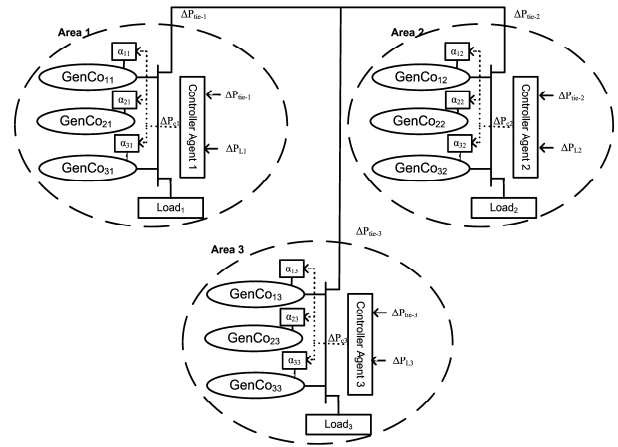

Fig. 6 The proposed multi-agent structure for three-control area power system.

$(\Delta P_{tie}, \Delta P_L)$ of the model, and digitizes them for the BNT (the BNT does not work with continuous values). The BNT finds the posterior probability distribution $p(\Delta P_c | \Delta P_{tie}, \Delta P_L)$ related to each area, then the controller agent finds the maximum posterior probability distribution from the return set and gives the most probable evidence ΔP_c in the control area. Using this change to the governors setting and the current values of the load disturbances the tie-line power deviation is integrated for the next time.

5 Simulation Results

To demonstrate the effectiveness of the proposed control design, some simulations were carried out. In these simulations, the proposed controllers were applied to the three-control area power system described in Fig. 6. In this Section, the performance of the closed-loop system using the linear robust PI controllers [11,12] compared to the designed Bayesian networks multi-agent controller will be tested for the various possible load disturbances.

Case1: As the first test case, the following large load disturbances (step increase in demand) are applied to three areas:

$\Delta Pd_1=100$ MW; $\Delta Pd_2=80$ MW; $\Delta Pd_3=50$ MW;

The frequency deviation (Δf) area control error (ACE) and control action (ΔP_c) signals of the closed-loop system are shown in Fig. 7.

Case 2: Consider larger demands by areas 2 and 3, i.e.

$\Delta Pd_1=100$ MW; $\Delta Pd_2=100$ MW; $\Delta Pd_3=100$ MW;

The closed-loop responses for each control area are shown in Fig. 8.

Using the proposed method the ACE and frequency deviation of all areas are properly driven back to zero, as well as robust controllers. Also, the convergence speed of the frequency deviation and the ACE signal to its final values are good; they attain to the steady state as rapidly as the signals in [11, 12]. However, the maximum frequency deviation occurs at 2 sec. in which load disturbances occur.

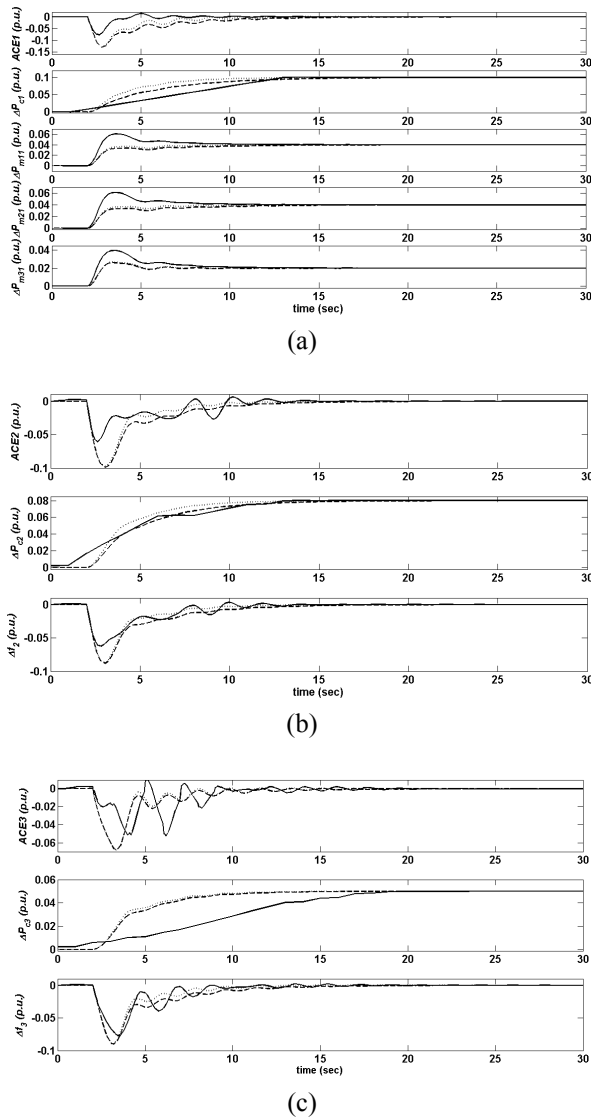

Fig. 7 System responses in case 1, (a) area 1, (b) area 2, (c) area 3, (Solid line: proposed method, dotted line: robust PI controller [11], dashed line: robust PI controller [12]).

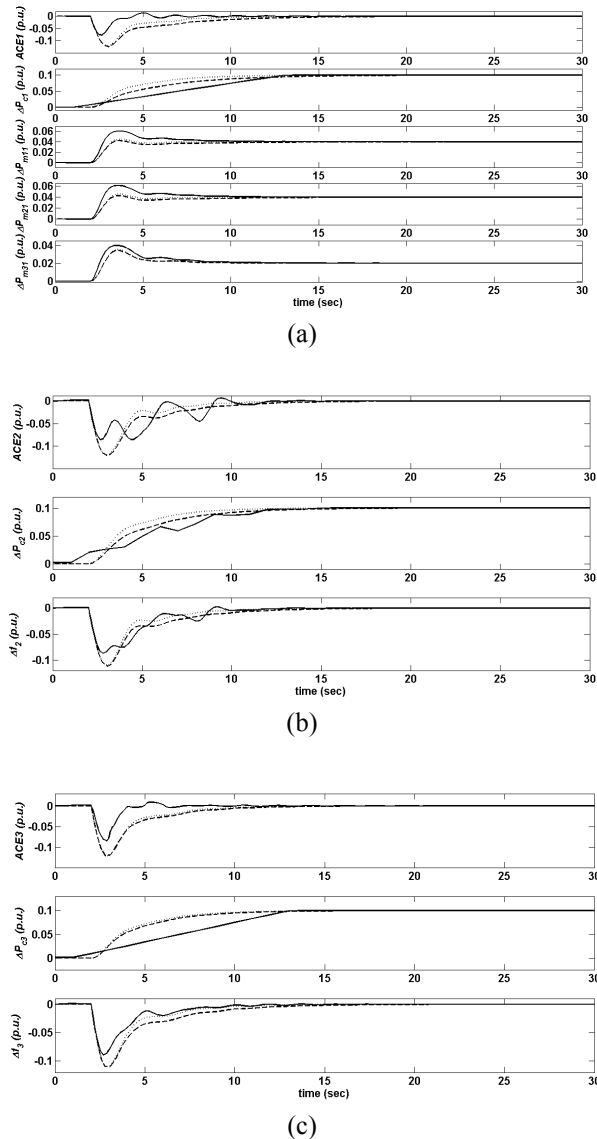

Fig. 8 System responses in case 2, (a) area 1, (b) area 2, (c) area 3, (Solid line: proposed method, dotted line: robust PI controller [11], dashed line: robust PI controller [12]).

As shown in the above figures, the generation control signal deviation (DPC) change is low and it smoothly goes to the steady state and satisfies the system physical conditions well. Also, it is clear that the DPM (mechanical power deviation) is proportional to the participation factor of each generator precisely.

Furthermore, assuming that the proposed algorithm is an adaptive algorithm and is based on the learning methods – in each state, it finds the local optimum solution so as to gain the system objectives (the ACE signal near zero) – therefore the intelligent controllers provide smoother control action signals.

6 Conclusions

A new method for LFC, using a Bayesian networks multi-agent based on genetic algorithm optimization has been proposed for a large-scale power system. The

proposed method was applied to a three-control area power system and was tested with different load change scenarios. The results show that the new algorithm performs very well, compares well with the performance of recently designed linear controllers. The two important features of the new approach: model independence from power system parameters and flexibility in specifying the control objectives, make it very attractive for this kind of applications. However the scalability of Bayesian networks multi-agent to realistic problem sizes is one of the great reasons to use it. In addition to scalability and benefits owing to the distributed nature of the multi-agent solution, such as parallel computation, Bayesian networks provide a robust probabilistic method of reasoning with uncertainty. They are more suitable to represent complex dependencies among components and can take into consideration load uncertainty as well as dependency of load in different areas.

7 References

- [1] Jaleeli N., Ewart D. N. and Fink L. H., "Understanding automatic generation control", *IEEE Trans. Power Syst.* Vol. 7, No. 3, pp. 1106-1112, 1992.
- [2] Hiyama T., "Design of decentralised load-frequency regulators for interconnected power systems", *IEE Proc. C Gener. Transm. Distrib.* Vol. 129, pp. 17-23, 1982.
- [3] Feliachi A., "Optimal decentralized load frequency control", *IEEE Trans. Power Syst.* Vol. 2, No. 2, pp. 379-384, 1987.
- [4] Liaw C. M., Chao K. H., "On the design of an optimal automatic generation controller for interconnected power systems", *Int. J. Control.* Vol. 58, No. 1, pp. 113-127, 1993.
- [5] Wang Y., Zhou R. and Wen C., "Robust load-frequency controller design for power systems", *IEE Proc. C Gener. Transm. Distrib.* Vol. 140, No. 1, pp. 11-16, 1993.
- [6] Lim K. Y., Wang Y. and Zhou R., "Robust decentralised load frequency control of multi-area power systems", *IEE Proc., Gener. Transm. Distrib.* Vol. 5, No. 143, pp. 377-386, 1996.
- [7] Ishi T., Shirai G. and Fujita G., "Decentralized load frequency based on H-inf control", *Electr. Eng. Jpn.* Vol. 3, No. 136, pp. 28-38, 2001.
- [8] Kazemi M. H., Karrari M. and Menhaj M. B., "Decentralized robust adaptive-output feedback controller for power system load frequency control", *Electr. Eng. J.* Vol. 84, No. 2, pp. 75-83, 2002.
- [9] El-Sherbiny M. K., El-Saady G. and Yousef A. M., "Efficient fuzzy logic load-frequency controller", *Energy Convers. Manage.*, Vol. 43, No. 14, pp. 1853-1863, 2002.
- [10] Bevrani H. and Hiyama T. "Robust load-frequency regulation: a real-time laboratory experiment", *Optimal Control Applications and Methods*, Vol. 28, No. 6, pp. 419-433, 2007.
- [11] Rerkpreedapong D., Hasanovic A. and Feliachi A., "Robust load frequency control using genetic algorithms and linear matrix inequalities", *IEEE Trans. Power Syst.* Vol. 2, No. 18, pp. 855-861, 2003.
- [12] Bevrani H., Mitani Y. and Tsuji K., "Robust decentralised load-frequency control using an iterative linear matrix inequalities algorithm", *IEE Proc. Gener. Transm. Distrib.* Vol. 3, No. 151, pp. 347-354, 2004.
- [13] Karnavas Y. L. and Papadopoulos D. P., "AGC for autonomous power system using combined intelligent techniques", *Electric power systems research*, Vol. 62, No. 3, pp. 225-239, 2002.
- [14] Demiroren A., Zeynelgil H. L. and Sengor N. S., "Automatic generation control for power system with SMES by using neural network controller", *Electr. Power Comp Syst.* Vol. 31, No. 1, pp. 1-25, 2003.
- [15] Du X. and Li P., "Fuzzy logic control optimal realization using GA for multi-area AGC systems", *International Journal of Information Technology*, Vol. 12, No. 7, pp. 63-72, 2006.
- [16] Daneshfar F. and Bevrani H., "Load-Frequency Control: A GA-based Multi-agent Reinforcement Learning", *IET Generation, Transmission & Distribution*, Vol. 4, No. 1, pp. 13-26, 2010.
- [17] Pearl J., *Probabilistic Reasoning in Intelligent Systems: networks of plausible inference*; Morgan Kaufman Publishers Inc: San Francisco CA, 1988.
- [18] Bevrani H., Daneshfar F. and Daneshmand P. R., "Intelligent Automatic Generation Control: Multi-agent Bayesian Networks Approach", *Int. Conference on Control Applications*, CD-ROM, IEEE, Yokohama, 2010.
- [19] Yongli Z., Limin H. and Jinling L., "Bayesian Networks-Based Approach for Power Systems Fault Diagnosis", *IEEE Transactions on Power Delivery*, Vol. 21, No. 2, pp. 634-639, 2006.
- [20] Yu D., Nguyen T. C. and Haddawy P., "Bayesian network model for reliability assessment of power systems", *IEEE Transactions on Power Systems*, Vol. 14, No. 2, pp. 426-432, 1999.
- [21] Chien C. F., Chen S. L. and Lin Y. S., "Using Bayesian network for fault location on distribution feeder", *IEEE Transactions on Power Delivery*, Vol. 17, No. 3, pp. 785-793, 2002.
- [22] Bobbio A., Portinale L., Minichino M. and Ciancamerla E., "Improving the Analysis of Dependable Systems by Mapping Fault Trees into Bayesian Networks", *Reliability Engineering and*

System Safety Journal, Vol. 71, No. 3, pp. 249-260, 2001.

- [23] Murphy K., *An introduction to graphical models*, 2001.
- [24] Bevrani H., *Real power compensation and frequency Control*; in: *Robust power system frequency control*, 1st edn, Springer Press, 2009.
- [25] Murphy K., "The bayes net toolbox for matlab", *Computing Science and Statistics*, Vol. 33, 2001.
- [26] Hajizadeh A. and Aliakbar-Golkar M., "Fuzzy Control of Fuel Cell Distributed Generation Systems", *IJEEE*, Vol. 3, No. 1, pp. 31-41, 2007.



Fatemeh Daneshfar received B.Sc. degree in Electrical and Computer Engineering from University of Tehran, Tehran, Iran, in 2003 and after several years work in Industry she received her M.Sc. degree in Artificial Intelligence at the Department of Electrical and Computer Engineering in University of Kurdistan in 2009. Her research interest is on multi-agent

control systems. She is one of the UoK IEEE student branch stabilizers and she is the chairperson of university of Kurdistan IEEE student branch from fall 2008 until fall 2009. She is a teacher at Department of Electrical and Computer Engineering in University of Kurdistan from fall 2010 until now.



Hassan Bevrani received Ph.D. degree from Osaka University (Japan) in 2004, in electrical engineering. From 2004 to 2006, he was a Postdoctoral Fellow at Kumamoto University (Japan). From 2007 to 2008, he was a Senior Research Fellow at Queensland University of Technology (Australia). In 2009 to 2010, he was a professor in Kumamoto University. From 2000, he has been an academic member at University of Kurdistan (Iran). His special fields of interest include intelligent and robust control applications in Power system and Power electronic industry.



Fathollah Mansoori was born in Sanandaj of Kurdistan, Iran, in 1979. He received B.Sc. degree in Electrical and Computer Engineering from University of Tehran, Tehran, Iran, in 2002 and M.Sc. degree in Computer Architecture from Iran University of Science and Technology in 2005, Tehran, Iran. He is with the Computer Engineering Department, Islamic Azad

University of Buin-Zahra, Buin-Zahra, Iran from 2005 until 2009. His research interest is on multi-agent systems and intelligent solutions for control systems.