

Automatic Phase Advancing in a Stand-Alone Switched Reluctance Generator at Different High Speeds for Desired Output Voltage

E. Afjei* and M. Asgar*

Abstract: The switched reluctance motor is a singly excited, doubly salient machine which can be used in generation mode by selecting the proper firing angles of the phases. Due to its robustness, it has the potential and the ability to become one of the generators to be used in harsh environment. This paper presents an energy conversion by a Switched Reluctance Generator (SRG) when bifilar converter circuit and discrete position sensors are employed. As the generator's speed increases by a prime mover the shape of current waveform changes in such a way that limits the production of generating voltage. At high speeds, it is possible for the phase current never reaches the desired value to produce enough back-emf for sufficient voltage generation, therefore, the output power falls off. In order to remedy this problem, the phase turn on angle is advanced in a way that the phase commutation begins sooner. Since one of the advantages of this type of generator is its variable speed then, the amount of advancing for the turn on angle should be accomplished automatically to obtain the desired output voltage according to the speed of the generator, meaning, as the generator speed increases so should the turn on angle and vice versa. In this respect, this paper introduces an electronic circuit in conjunction with the position sensors and the drive converter to achieve this task for a desired output voltage when a SRG feeding a resistive load. To evaluate the generator performance, two types of analysis, namely numerical technique and experimental studies have been utilized on a 6 by 4, 30 V, SRG. In the numerical analysis, due to highly non-linear nature of the motor, a three dimensional finite element analysis is employed, whereas in the experimental study, a proto-type generator and its circuitries have been built and tested using bifilar converter. A linear analysis of the current waveform for the generator under different advancements of the turn on angle has been performed numerically and experimentally and the results are presented.

Keywords: SRG, Switched Reluctance Generator & control, phase advancing and SRG.

1 Introduction

SRG can be considered as one of the attractive options for worldwide increasing demand of electrical energy. It is low cost, fault tolerant with a rugged structure and operates with acceptable efficiency over a wide speed range. Due to the nonexistence of windings and permanent magnets on the rotor parts, high rotational speeds and high-temperature are possible. Furthermore, the absence of windings on the rotor causes the majority of the losses to show up in the stator, making the SRG relatively easy to cool. There have been many researches on SRG characteristics utilizing asymmetry

half bridge converter [1-3]. The SRGs as well as switched reluctance motors use the same topologies and techniques for drive circuits and rotor position control algorithms [4, 5]. Applying has been proved functional and useful for some applications like starter/generator for gas turbine of aircrafts [6, 7], wind turbine generator [8-10] and starter/alternator electric cars [11, 12]. The solid structure of SRG is useful for an ultra-high speed generator such as a micro gas turbine generator [13].

In [14], a new performance criteria as productivity of generator is described. In this method, instead of two phase commutation steps, which are on and off in single pulse mode, a freewheeling step is added. During this step, the phase is short circuited and the current increases due to back-emf voltage. This method produces more power than the conventional method, for the same turn on period.

Iranian Journal of Electrical & Electronic Engineering, 2012.

Paper first received 06 Aug. 2011 and in revised form 03 Dec. 2011.

* The Authors are with the Department of Electrical & Computer Engineering, Shahid Beheshti University G. C., Tehran, Iran.

E-mails: e-afjei@sbu.ac.ir and m_asgar@sbu.ac.ir

The start and duration of current pulses for each phase in a SRG is controlled and synchronized with rotor position by means of a direct or an indirect shaft positioning scheme [5]. The performance of SRG can be greatly influenced by choosing the proper starting time for the phase turn on angle at different speeds [15]. The time duration τ available for current in each phase winding is directly related to the speed of the generator. As the generator's speed increases the amount of time, τ , decreases and at some point, it can reach a certain value such that, the control of the winding current for obtaining a desired value is impossible. At high speeds, the current cannot rise quickly enough in the phase winding to reach the preferred level. Due to this reason, it is desirable to get current into the generator phase winding before the phase inductance reaches generating mode. Hence, turn on and turn off angles can be defined as control variables, where, turn on angle is set to accomplish the output power and the turn off angle is selected to achieve optimal efficiency at each power level and speed. In general, there are two methods to boost the current rise time namely, varying the dwell angle, and use of smaller number of turns during excitation mode can be considered. These options will allow keeping SRG output voltage constant at high speeds where current control (PWM) is not a possible option anymore.

2 Excitation and Generation Modes of Operation

A SRG needs some means of excitation to generate electrical energy. This excitation can be achieved by utilizing a converter circuit. Fig. 1 shows one of generator phase winding and its drive circuit.

Closing the main switch, S1 will cause a current build up in the SRG phase winding. Once the main switch is turned off, more energy is returned to the source than was provided for excitation through the bifilar windings.

For generator operation, excitation generally begins near the aligned position for relatively low-speed operation. The excitation is often advanced with increasing speed so that excitation begins before the aligned position. This is analogous to the phase advancing introduced in the control of the SRM [16]. At the start of phase excitation the phase current and the back-emf are zero. The back-emf begins to build up as

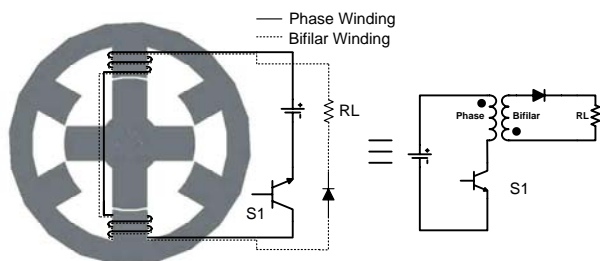

Fig. 1 A 6 by 4 SRG, one phase winding and its bifilar drive circuit.

the phase currents goes up. The back-emf direction supports phase build up when a positive voltage is applied to the phase winding. When voltage source is turned off, phase current build up is supported entirely by the back-emf. Power generation begins during demagnetization when the generator phase winding is subjected to a negative source voltage or connected to a load. The phase current magnitude during this period depends on the magnitude of the back-emf and the voltage supply. A typical inductance and current waveforms of a SRG is shown in Fig. 2.

A stator phase winding is energized during the rising part of inductance profile hence, the turn-on angle falls before the fully aligned rotor/stator poles positions and the turn off angle falls during the negative slope of inductance profile which is located after fully aligned position, during this period machine generates power back into the voltage supply or the load. Excitation period begins from turn-on angle θ_{on} to turn-off angle θ_{off} . In this period external voltage supply is applied to the stator phase winding. The period of generation mode is defined from θ_{off} to θ_{end} . In This period the energy stored in the stator winding is released through diodes or bifilar winding till the phase current reaches zero. Here θ_{on} illustrates the position at which the main drive switch is turned on. Correspondingly, θ_{off} depicts the position at which the main transistor is off allowing the generating current to flow through the bifilar winding into the load.

3 Operating Theory of SRG

Although saturation plays an important role in obtaining the exact behavior of the SRG, and also is necessary for the detailed generator design, but analysis of magnetically linear SRG can provide useful and broad understanding of the influence of the many generator parameters.

The equation for the SRG phase voltage shown in Fig. 1 can be expressed as follows:

$$V = Ri + \frac{\partial \lambda}{\partial t} \quad (1)$$

By expanding Eq. (1), the following form is obtained:

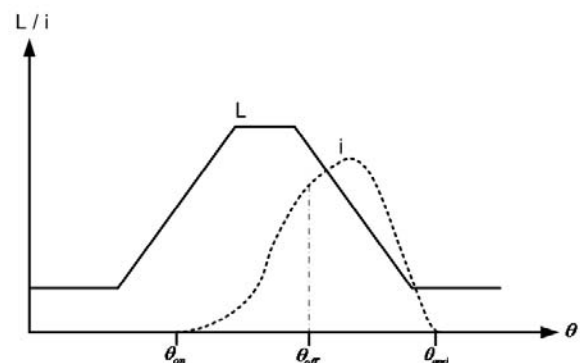

Fig. 2 Typical inductance and current waveforms of a SRG.

$$V = Ri + L(\theta) \frac{di}{dt} + \omega \frac{\partial L(\theta)}{\partial \theta} + i \frac{\partial L(\theta)}{\partial i} \frac{di}{dt} \quad (2)$$

In the above expression i , L , ω , θ , V are phase current, phase inductance, rotor speed, rotor position angle, and phase voltage respectively. If the effects of saturation are neglected this expression can be rewritten as:

$$V = Ri + L(\theta) \frac{di}{dt} + \omega i \frac{\partial L(\theta)}{\partial \theta} \quad (3)$$

The last part of Eq. (3) is the back-emf. Analysis of the back-emf gives an important insight into SRG operation. First, back-emf is a function of phase current, machine speed and phase inductance. Second, the back-emf polarity depends on the inductance variation. The back-emf sign is negative during the generating mode, which occurs in the period of decreasing phase inductance with respect to the rotor position.

4 Formulation and Analysis of the Generator

Assuming operation in the linear portion of magnetization curve and solving for current as a function of time results in:

$$i = \frac{V_s}{R + \frac{dL}{d\theta} \omega} + [I_0 - \frac{V_s}{R + \frac{dL}{d\theta} \omega}] e^{-\frac{t}{\tau}} \quad (4)$$

where I_0 is the initial current at each step, and

$$\tau = \frac{L(\theta)}{R + \frac{dL(\theta)}{d\theta} \omega} \quad (5)$$

Since the term appears in the denominator of Eq. (4) the current is extremely sensitive to turn-off angle θ_{off} especially if it falls in the negative slope of phase inductance with respect to the rotor position.

In order to be able to plot the current profile for a SRG, the parameters in Eq. (4) are found by either numerically or experimentally for a 6 by 4, three phase, 30 V switched reluctance generator with the following specifications;

Stator core outer diameter	= 72 mm
Stator core inner diameter	= 62 mm
Rotor pole arc	= 32°
Stator pole arc	= 28°
Stack length	= 35 mm
Air gap	= 0.25 mm
Rotor core outer diameter	= 39.5 mm
Rotor shaft diameter	= 10 mm
Number of turns per pole	= 2×75.

In the numerical part, the magnetic field analysis has been performed using a commercial finite element package [17], which is based on the variational energy minimization technique known as T-Ω method to solve for the electric vector potential. This simulation directly

yields prediction of magnetic flux densities and flux linkages. The so called “effective” inductance has been defined as the ratio of each phase flux linkages to the exciting current (λ/I). Values based on this definition are presented in Fig. 3 for the generator under investigation. In the analysis the rotor moves from fully unaligned (i.e. -45°) to completely aligned (i.e. 0°) and then to fully unaligned (i.e. +45°) positions.

In the unaligned position the “effective” inductance is at its lowest value and increases as the generator poles go into aligned position. Maximum inductance value is achieved at fully aligned stator/rotor poles position. Minimum and maximum values of inductance for different current values are shown in Fig. 3. In this analysis the maximum and minimum effective inductance values used in the calculations are 4 mH and 18 mH, respectively.

Substituting these inductance values into Eq. (4), and for a speed of 5000 RPM the current for the different regions of inductance profile has been evaluated.

In every region the value of inductance considered to be constant for a very short period of time in order to be able to compute the value of current in Eq. (4). Fig. 4 shows the current waveform for entire inductance profile shown in Fig. 3. The phase current has been computed and plotted starting from the time when switch S_1 is closed at 15° before the start of rotor/stator poles alignment (i.e. -45°) till the switched is turned off at 9° in negative slope of phase inductance with respect to rotor position. During the generating mode the current discharges into an 18 Ω resistive load.

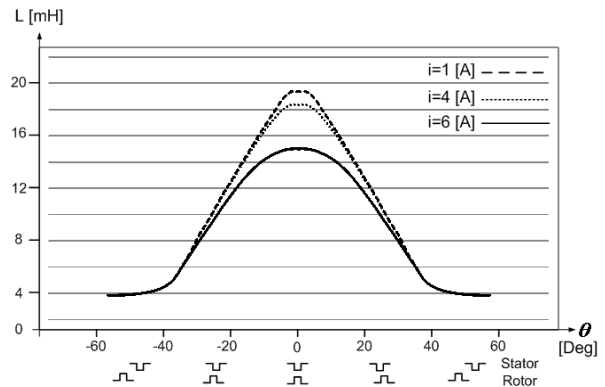

Fig. 3 Terminal inductance versus rotor position.

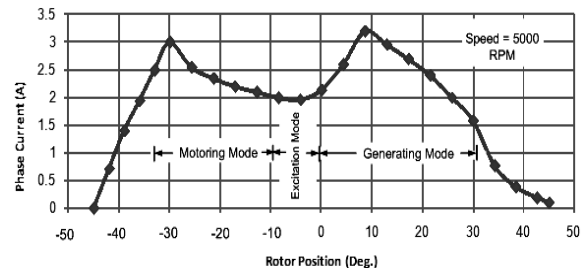

Fig. 4 Current waveform from -45° to +45° of rotor position.

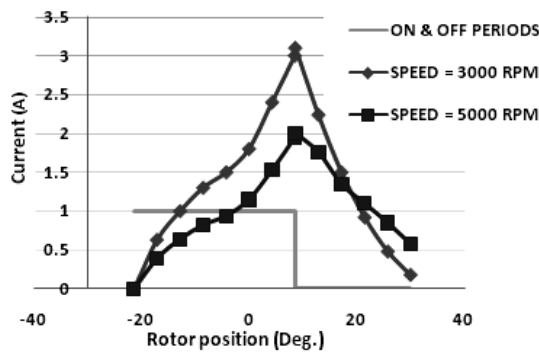

Fig. 5 Current waveforms for two different speeds.

The different parts of current waveforms in Fig. 4 may be explained with reference to the simulated inductance profile of Fig. 3. The phase winding is connected via switch S_1 to the voltage source V_s at $t=0^0$ or $\theta=-45^0$ while the phase inductance is at its lowest value and is roughly constant, thus permitting current builds up at almost a fast rate until the rotor poles reach the stator poles. At this position (i.e. $\theta=-30^0$) the phase inductance begins to increase rapidly. The fast positive rate of change of phase inductance value with respect to rotor position causes the current to fall. The current now is flowing through switch S_1 and decaying. At zero degree position, the value of current has reached to about 2 A. A little bit after this time, the rate of inductance value with respect to the rotor position, θ is negative and switch S_1 is still on, hence the current builds up now is due to the negative sign of back-emf.

During this period current flows from the voltage supply and energy is stored in the machine. This energizing period is known as the excitation time and is necessary because the SR machine is a singly excited machine. At 9^0 rotor position S_1 is turned off and all stored energy will be released to the resistive load during the negative slope of inductance profile. This period is known as the generating mode of machine's operation. Fig. 5 shows the current waveforms at two different speeds having the same turn-on angles as well as the excitation periods.

It is clearly shown in Fig. 5 that, the current waveform for the motor with higher speed yields smaller stator phase current in the exciting as well as generating modes. More advancement in conduction angle produces larger current at high speeds before exciting mode, hence higher back-emf is achievable and more generating power can be produced. Eq. (4) for current reveals that the exciting current is extremely sensitive to turn-off angle θ_{off} especially if it falls in the negative slope of phase inductance with respect to the rotor position.

Therefore, this position is fixed at fully aligned rotor/stator poles and the turn-on angle θ_{on} is varied. Now the validity of producing higher generating current when the turn-on angle is varied but the turn-off angle is kept fixed at some rotor position is examined. Fig. 6

shows the effect of turn on angle advancing on the exciting and generating current waveforms at

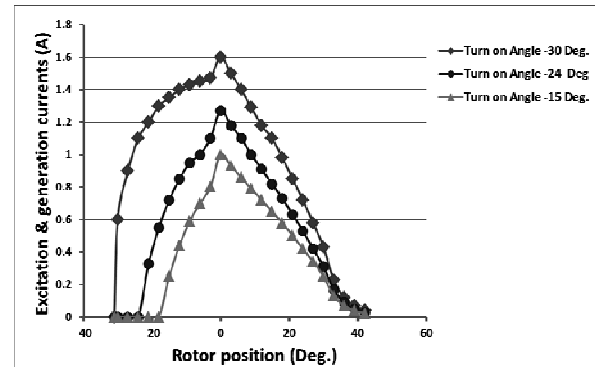
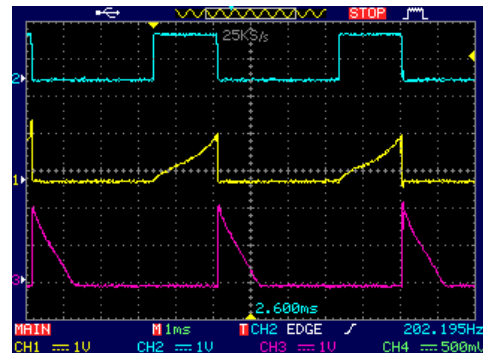
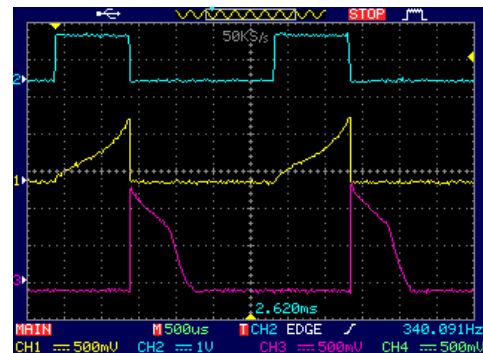

Fig. 6 Excitation and Generation currents at 5000 RPM, for three different turn on angles.



a) 3000 RPM, and 15^0 adv.



b) 5000 RPM, and 15^0 adv.

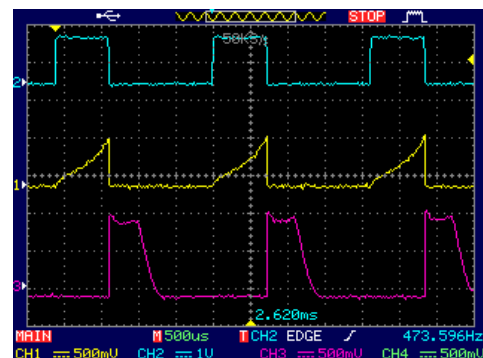

c) 7000 RPM, and 15^0 adv.

Fig. 7 Generator on time period of one power switch phase currents in the main and bifilar windings.

5000 RPM, using Eq. (4). In this Fig the main drive power switch is set to turn off at 0° or fully aligned rotor position. As shown in Fig. 6 variation of excitation period has direct effect on both current waveforms.

In order to see the shape of the actual current waveforms under different turn on angles, a set of optical sensors, having adjustable positions with respect to rotor poles are fixed at the end of the 6 by 4 SRGs.

Fig. 7 shows the actual generator phase currents wave forms in the main and bifilar windings as well as the on time period for the power switches at different speeds versus time having 15° advancement angle, respectively. Fig. 7 clearly shows the shape of current changes as the speed of generator prime mover goes up. Having different current slopes during discharge is due to different time constants for the duration of negative rate of inductance with respect to rotor position and also time constant after rotor pole leaves the stator pole. The oscilloscope probe is set to $\times 10$ for measurement of the output current waveform.

Fig. 8 shows the average excitation current produced by a 12 V constant voltage supply with the same advancement angle and equal on time switching period through the generator phase windings at different speeds. As seen from Fig. 8, the current drops exponentially as the speed goes up. The main reason is due to $R + \frac{dL}{d\theta}\omega$. in the denominator of Eq. (4). In other words, the current does not have sufficient time to build up as the generator speed goes up.

5 Experimental Study

Advanced conduction angle at the generator starting (i.e. $i_{phase}=0$) can have profound effect on power production mechanism since higher current is achievable before and during exciting mode. Small advancements in turn on angle for medium and high generator speeds will cause low current build up during the excitation mode; therefore the produced output voltage due to the generator back-emf effect is low. The amount of advancing at different speeds to produce the needed output voltage cannot be a fixed value. Therefore, a means of producing variable advancements in commutation angle for different speeds is required. An electronic circuit is designed and used to accomplish

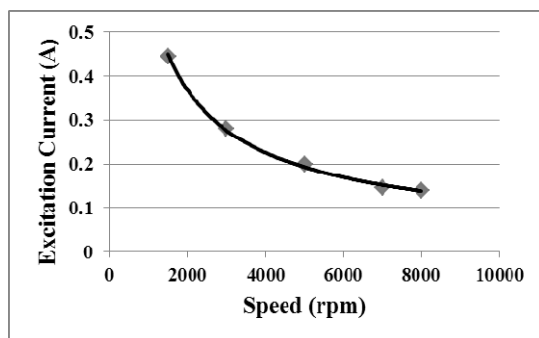

Fig. 8 DC excitation current through the generator.

this task for a 6 by 4 SRG. A block diagram of the circuit for the SRG is shown in Fig. 9.

There are three 30° pulses produced by the generator shaft position sensors in every 90° of shaft rotation. These pulses are fed into a pulse-shaping unit in order to get 3 series pulses of 30° width per 90° revolution as shown in Fig. 10-a, and 10-b.

The frequency of this pulse train is increased to 30 times higher by employing a P.L.L. module. The P.L.L. module comprises of a CMOS 4046 and a 40102 counter integrated circuits. The P.L.L. output produces a pulse train with one-degree resolution in comparison with the original 30° generator pulses. There are thirty pulses embedded in every 30° of generator position sensor as shown in Fig. 11.

Fig. 11-a shows the output of P.L.L. module which covers all the three signals from the position sensors while Fig. 11-b depicts only phase A sensor output pulse. This pulse train and the pulse shaping unit output signal are fed into the counter module. The amount of phase turn on advancement variation is set by an AVR

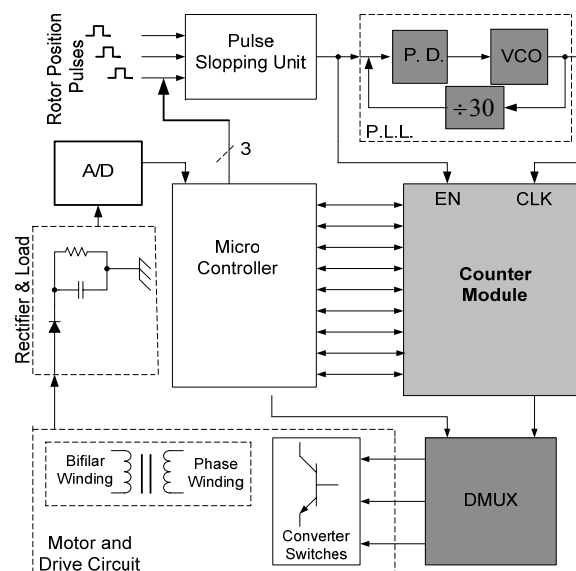

Fig. 9 Block diagram of the controller circuit for the SRG.

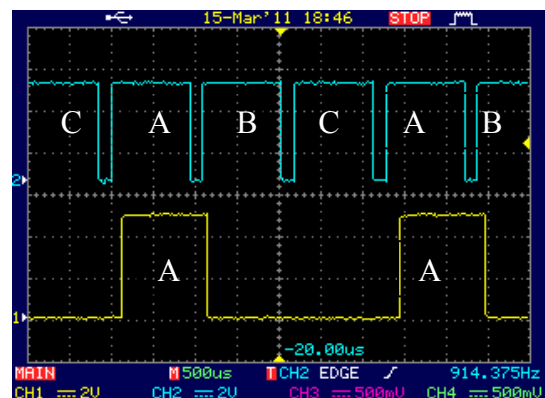

Fig. 10 a) Output of the pulse shaping unit. b) Generator pulses of phase A.

Atmel microcontroller, which measures the generator output voltage. A predefined look-up table for the output voltage/advancement angle will generate the proper advancement angle. This table is used in this paper because high speed assumption made at the beginning. It is possible to expand this table to include the generator speed, output voltage and the amount of advancement angle as well.

In this way, if the generator is running at slow speeds only pulse width modulation for the field current should act and set the output voltage. If the generator speed goes higher than some preset value such that it would not be able to produce the desired output power then PWM is kept constant at 100% and advancing of turn on angle begins. The user can define this table in any way desired. Fig. 12 shows the written algorithm in flowchart form for the microcontroller.

The counter module output pulses are separated into three independent advanced generator pulse trains by a demultiplexer. Figs. 13 and 14 show the original pulse

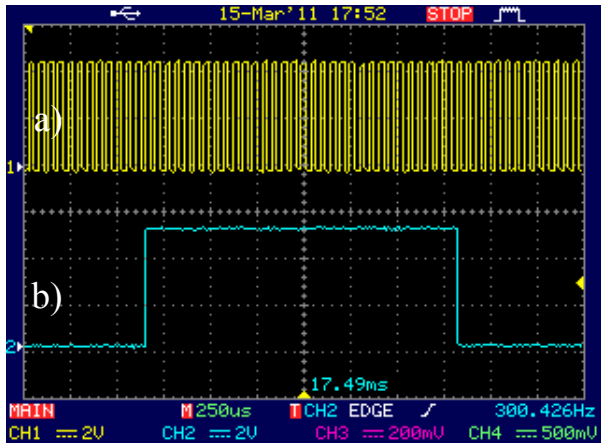

Fig. 11 a) Generator pulses of phase A. b) Output of the P.L.L. module.

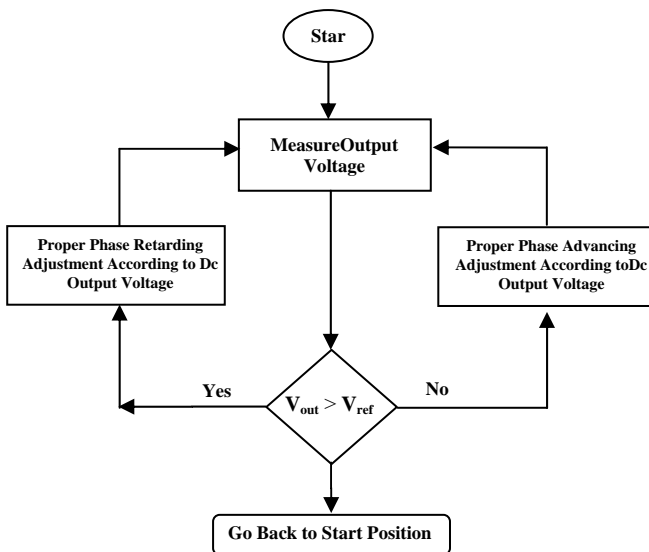

Fig. 12 Algorithm in flow chart form for the microcontroller.

trains from the generator shaft position sensors (a), produced pulses by the controller circuit after 15° and 23° degrees firing angle adjustments (b), power transistor on time period (c), and exciting as well as generating current waveforms (d) for phase A, respectively. It is worth mentioning that the original pulses from generator position sensors are set at 15° advance (i.e. $\theta = -30^\circ$) as the base for the microcontroller calculations. As the generator speed increases, a time delay will be produced by the microcontroller with respect to the position sensors output pulses. In another words, the produced pulses are advanced in reference to start of machine's exciting and generating periods.

As shown in Figs. 13 and 14 the pulses going into the generator drive circuit are delayed compared to the position sensors pulses which in turn are translate to producing pulses which are advanced in the reference frame of machine's generating mode. Figs 13-d and 14-d show two exciting current waveforms each is 30° long (i.e. $\omega t = 30^\circ$) as well as two other waveforms known as generating current waveforms.

The exciting current waveforms are increasing exponentially with different time constant due to variable inductance values at different rotor positions.

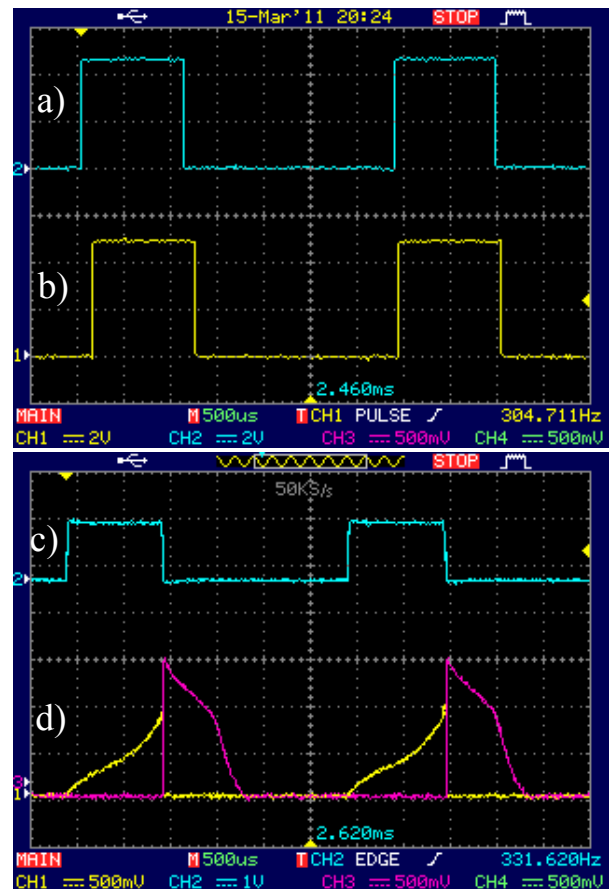

Fig. 13 Generator position sensor pulses and currents. a) Original generator pulses. b) 15° advanced Pulse. c) Main transistor switching pulses. d) Excitation and generation current waveforms.

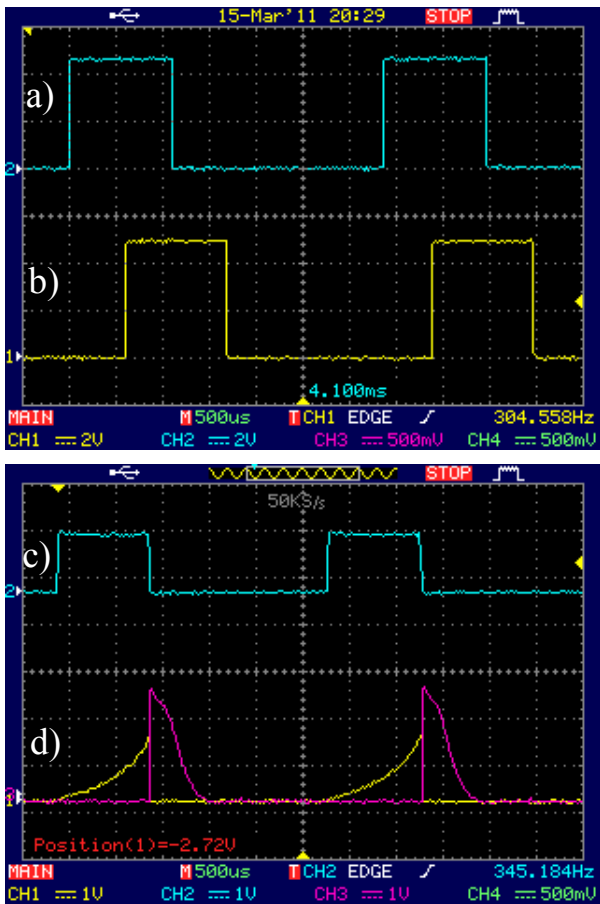

Fig. 14 Generator position sensor pulses and currents. a) Original generator pulses. b) 23° advanced Pulse. c) Main transistor switching pulses. d) Excitation and generation current waveforms.

Each generating current waveform has two different slopes. The first slope in those two waveforms is due to the fact that the rotor/stator poles still have overlapped areas between them while, the second slope is produced when there is no overlapped area exists.

6 Conclusion

An electronic circuit has been built and employed for a 6 by 4 SRG. This circuit causes the phase commutation begins sooner and ends sooner, therefore the current has sufficient time to build up to the proper level before reaches the generator excitation mode. The amount of phase commutation advancing which is related to the generator output voltage is obtained from a desired voltage/angle table programmed into the microcontroller. The test results using this circuit show a great improvement and control in keeping the output voltage at a desired level at variable high speeds. This technique solves one of the drawbacks of the switched reluctance generators especially at high variable speed. The general shapes of the current waveforms found experimentally support the results obtained numerically. The difference in the values of maximum current found by these two methods is within 18% and this variation is

due to the assumptions made in the magnetic circuit of the generator for developing the current equation. The solution for the generator current during the excitation mode reveals that, the current is extremely sensitive to turn-off angle hence, it is better to set this angle at some fixed optimized position and vary the turn-on angle.

Acknowledgment

This work was supported by vice-presidency of research and technology of Shahid Beheshti University, contract #600-1959.

References

- [1] Takahashi A., Goto H., Nakamura K., Watanabe T. and Ichinokura O., "Characteristics of 8/6 Switched Reluctance Generator Excited by Suppression Resistor Converter", *IEEE Transactions on Magnetics*, Vol. 42, No. 10, pp. 3458–3460, Oct. 2006.
- [2] Torrey D A., "Switched Reluctance Generators and Their Control", *IEEE Transactions on Industrial Electronics*, Vol. 49, No. 1, pp. 556–565, Feb. 2002.
- [3] Susitra D., Annie E. and Jebaseeli E., "Switched Reluctance Generator - Modeling, Design, Simulation, Analysis and Control A Comprehensive Review", *International Journal of Computer Applications*, Vol. 1, No. 2, pp.10–16, 2010.
- [4] Asgar M. and Afjei E., "A New Class of Resonant Discharge Drive Topology for Switched Reluctance Motor", *Iranian Journal of Electrical & Electronic Engineering*, Vol. 5, No. 4, pp. 261–269, 2009.
- [5] Sedghizadeh S., Lucas C. and GhafooriFard H., "Sensorless Speed Control of Switched Reluctance Motor Drive Using the Binary Observer with Online Flux-Linkage Estimation", *Iranian Journal of Electrical & Electronic Engineering*, Vol. 5, No.2, pp. 143–150, 2009.
- [6] MacMinn S. R. and Sember J. W., "Control of a Switched Reluctance Aircraft Starter-Generator over a Very Wide Speed Range", *Proc. Intersociety Energy Conversion Engineering Conf.*, pp. 631–638, 1989.
- [7] Emadi A. and Ehsani M., "Electrical System Architecture for Future Aircraft", *Proc. of 34th Intersociety Energy Conversion Engineering Conf.*, British Columbia, pp. 1–5, Aug. 1999.
- [8] Cardenas-Dobson R., Asher G. M. and Ray W. F., "Experimental Evaluation of a Switched Reluctance Generator for Wind Energy Application," *Wind Engineering*, Vol. 20, pp. 115–136, 1996.
- [9] Cardenas R., Pena R., Perez M., Clare J., Asher G. and Wheeler P., "Control of a Switched Reluctance Generator for Variable-Speed Wind Energy Applications", *IEEE Transactions on*

- Energy Conversion*, Vol. 20, No. 4, pp. 781-791, Dec. 2005.
- [10] Swiggan D. Mc., Xu L. and Littler T., "Modeling and Control of A Variable-Speed Switched Reluctance Generator Based Wind Turbine", *UPEC*, pp. 459-463, 2007.
- [11] Richter E. and Ferreira C., "Performance Evaluation of a 250 kW Switched Reluctance Starter Generator," *IEEE Industrial Application*, Vol. 1, pp. 434-440, 1995.
- [12] Fahimi B., Emadi A. and Sepe Jr., "A Switched Reluctance Machine Based Starter/Alternator for more Electric Cars", *IEEE Transactions on Energy Conversion*, Vol. 19, Issue: 1, pp. 116-124, March 2004.
- [13] Chong H., Kim Y. J. and Allen M. G., "A Planar Variable Reluctance Magnetic Micromotor with Fully Integrated Stator and Wrapped Coils", *Journal of Micro Electromechanical Systems*, Vol. 2, No. 4, pp. 165-173, 1993.
- [14] Dixon S. and Fahimi B., "Enhancement of Output Electric Power in Switched Reluctance Generators", *IEEE International Electric Machines and Drives Conference*, Vol. 2, pp. 849-856, June 2003.
- [15] Torrey D. A., "Switched Reluctance Generators and Their Control," *IEEE Transaction on Industrial Electronics*, Vol. 49, No. 1, pp. 3-14, Feb. 2002.
- [16] Afjei E. and Sahebi M. R., "Automatic Phase Advancing in Switched reluctance Motor by Employing An Electronic Governor For A

Desired Speed Angle Profile", *International Journal of Engineering*, Vol. 17, Transactions A: Basics, pp. 11-18, Feb. 2004.

- [17] Magnet CAD Package: User Manual, Infolytica Corporation Ltd., Montreal, Canada, 2006.



Ebrahim S. Afjei received the B.S. and M.S. degrees in Electrical Engineering from the University of Texas in 1984, 1986 respectively, and the Ph.D degree from New Mexico State University, in 1991. He is currently a professor in the Department of Electrical Engineering, Shahid Beheshti University, Tehran, Iran. His research interests are in the area of switched reluctance motor drives, Numerical analysis and Power Electronics.



Majid Asgar received the B.S. degree in Electrical Engineering from the Shahid Rajaei University, and M.S. degree in Electrical Engineering from the Shahid Beheshti University, Tehran, Iran, in 1993 and 2008, respectively. He is currently Ph.D student in Electrical Engineering, Shahid Beheshti University, Tehran, Iran. His research interests are in the areas of Power Electronics and switched reluctance motor drive.