

# A New Skewed-Rotor-Pole Switched Reluctance Motor Design

S. R. Mousavi-Aghdam<sup>\*(C.A.)</sup> and M. R. Feyzi\*

**Abstract:** This paper considers a new Switched Reluctance Motor (SRM) structure aiming at high starting torque with low volume. For some applications such as EVs (Electrical Vehicles), the motor volume and starting torque is a critical point in its design. In many methods, reducing the motor volume causes reduction in starting torque and decreases the motor efficiency. Unlike conventional SRMs, the rotor pole is skewed in the proposed structure along the motor axis. An approximated two-dimensional Finite Element Method (FEM) is used to speed up computational time and some comparisons with three-dimensional FEM are considered for more reliability. Final results show the efficiency of the proposed structure.

**Keywords:** Electromagnetic Fields; Finite Element Methods; Switched Reluctance Motor.

## 1 Introduction

SRM designs come into research and development in recent years with renewed structures. SRMs have simplest structure among all rotating electrical machines since their manufacture cost is the lowest compared to that of mainstream brushless poly-phase machines, such as induction, permanent magnet synchronous and brushless dc [1-3]. Improving the motor characteristics without any change in simplicity of the motor drive is an important issue in the new SRM development trends. An appropriate design can improve SRM performance but in some new structures [4-8], drive system may become complicated. Developing SRM to make it lightweight and low-volume is necessary in many applications such as EVs. On the other side, these applications need high-power motors. Several attempts such as [9] aimed at increasing SRM power, enlarge the motor size and limit their application. Therefore, the motor torque per volume cannot be improved sufficiently.

In this paper a new design for cylindrical SRMs is presented. The rotor pole is skewed to control total saturation process in the motor core and properly use the motor steel to produce more power as well as decrease its weight and volume. The proposed structure is suitable for some applications such as EVs. The paper is organized as follows. Section 2 describes the new design. Modeling considerations for the proposed SRM is presented in Section 3. Results and comparisons are

discussed in Section 4 and conclusions are summarized in Section 5.

## 2 Skewed-Rotor-Pole SRM

This section presents the basic concept of the skewed rotor pole SRM by describing how the new design decreases the total weight while retaining the starting torque. These characteristics are desirable features for applying to the EVs [10].

### 2.1 Motor Description

The skewed rotor pole SRM is shown in Fig. 1, which is of the conventional stator pole structure, where the rotor pole has a non-uniform shape along motor axis. One side of the rotor pole is not skewed and the rotor rotates in the direction in which this side of the pole is overlapped with the stator pole. In other words, the torque is produced along entire axis in the starting time and during the rotation is transferred toward one side of the rotor.

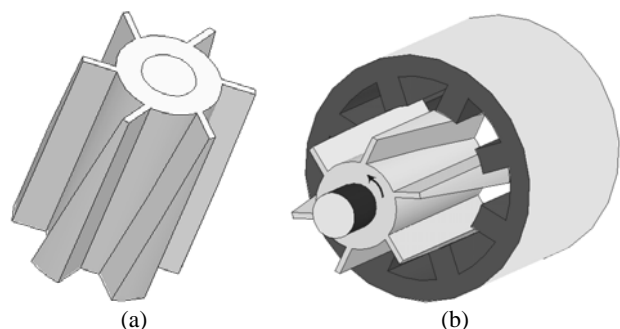

**Fig. 1** (a) Skewed rotor pole and (b) proposed SRM.

Iranian Journal of Electrical & Electronic Engineering, 2014.

Paper first received 21 Oct. 2013 and in revised form 13 Apr. 2014.

\* The Authors are with the Department of Electrical Engineering, University of Tabriz, Tabriz, Iran.

E-mails: Rmousavi@tabrizu.ac.ir and Feyzi@tabrizu.ac.ir.

Some potential advantages for the proposed new SRM are listed as below:

(1) The total motor weight is smaller in comparison to the conventional SRMs both in the rotor and stator sides. The skewed rotor poles have approximately half volume. The stator yoke width is designed to be wide enough to avoid magnetic saturation and in this structure, it can be reduced because of low saturation in the stator back iron as explained more in the next sections.

(2) Radial force is the main cause of vibration and acoustic noise. Let us define the air-gap area as  $S$  so that the magnetic force is expressed as in the well-known Maxwell stress equation

$$F = \frac{B_0^2}{2\mu_0} S \quad (1)$$

where  $B_0$  and  $\mu_0$  is the magnetic flux density and relative permeability in the air-gap respectively. According to Eq. (1) radial force is proportional to the overlapped area between the stator and rotor poles. That is because the radial force in the proposed design is considerably decreased.

(3) When the rotor and stator poles start to overlap, torque production is similar to that of conventional ones and then in the proposed design the motor starting torque is not affected by other features. In other words, the motor is worked in a high power with light weight while retaining its starting torque.

(4) From aerodynamic view of point, the skewed rotor pole SRM has a higher permissible temperature structure and makes the motor cooling easier.

## 2.2 Geometry Design

A schematic geometry of the proposed stator and rotor pole is shown in Fig. 2. The initial pole angles are designed as  $\beta_s$  and  $\beta_r$  for stator and rotor poles respectively, and  $l$  is the motor stack length. The principle of operation is so that in the initial step, the rotor and stator poles overlapped to the angle  $\beta_0$ . In this step, the overlapped area is uniform over the motor axis and torque is produced throughout it. In the second step, because of the new motor structure, the overlapped area is moved toward one side of the motor axis. Due to full overlapped area in the initial step, the motor starting torque is not reduced but in the next step, this area is reduced in comparison to conventional SRMs. Fig. 2 also shows that reluctance change with rotational displacements around the motor axis is higher than its change with linear displacement along the motor axis. Therefore, axial force can be neglected in the proposed design.

## 3 Modeling and FEM Analysis

A three-dimensional FEM is needed to analyze the proposed structure but to speed up computational time, an approximated two-dimensional FEM has been used for total motor geometry. In the proposed structure, air

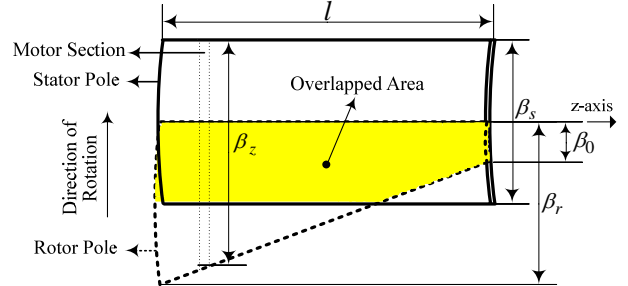

Fig. 2 View of the rotor and stator poles structure along motor axis.

gap magnetic flow is basically passed through paths which have the least reluctance. Because of stack lamination and its length compared with air gap length, the total tangential component of flow can be neglected. That is because to apply the approximated method, it is assumed that the air gap flow direction is radial (cross-sectional) and tangential component of the air gap flow is negligible. Therefore, the proposed SRM can be divided into several sections in z-direction. As shown in Fig. 2, these sections are selected small enough that operate as a conventional SRM with a small length. However, a precise differential equation can be used to calculate the motor total torque. To achieve this goal, the motor section shown in Fig. 2 is considered as a differential element. If rotor pole is skewed linearly then

$$\beta_z = \frac{1}{l}(\beta_0 - \beta_r)z + \beta_r \quad (2)$$

where  $\beta_z$  is the rotor pole angle for SRM differential element in z-axis. A typical SRM phase torque profile in the proposed structure can be obtained as shown in Fig. 3 considering the following formula ( $\beta_0$  is typically used as in [11, 12])

$$\beta_r = \beta_0 = 18^\circ \quad (3)$$

In Fig. 3, the motor static torque is a function of the rotor position and is considered as  $T(\theta)$ . The torque profile for SRM differential element with the rotor pole angle equal to  $\beta_z$  can be obtained using the following formula:

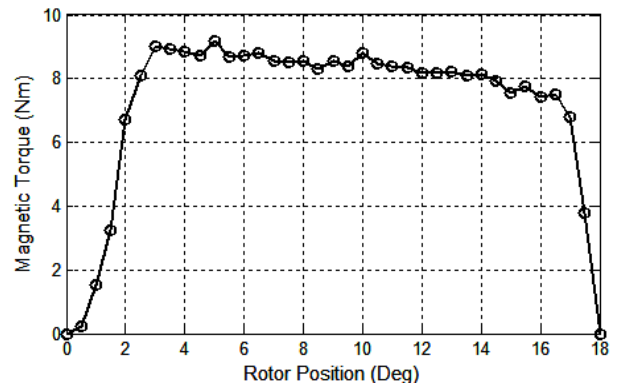

Fig. 3 Magnetic torque profile of SRM phase.

$$\tau_z(\theta) = T(\theta)[u(\theta) - u(\theta - \beta_z)] \quad (4)$$

where  $\tau_z(\theta)$  is the torque profile as a function of the rotor angle for the proposed SRM differential element and  $u(\theta)$  is the unit step function. In Eq. (4) the conduction phase angle is assumed to be as large as  $\beta_z$  in the proposed element. The total motor torque  $T_{tot}(\theta)$  in the skewed motor structure can mathematically written as

$$T_{tot}(\theta) = \int_0^l \tau_z(\theta) dz \quad (5)$$

Substituting Eq. (2) and Eq. (4) into Eq. (5) yields

$$T_{tot}(\theta) = lT(\theta)u(\theta) - \int_0^l T(\theta)[u(\theta - (\beta_0 - \beta_r)z/l - \beta_r)] dz \quad (6)$$

Solving Eq. (6) yields

$$T_{tot}(\theta) = \begin{cases} T_c(\theta), & \theta \leq \beta_0 \\ T_c(\theta) - T(\theta) \cdot (\beta_0 - \theta) \cdot (\beta_0 - \beta_r) / l, & \theta > \beta_0 \end{cases} \quad (7)$$

where  $T_c(\theta)$  is the motor torque profile for a conventional SRM which its length is  $l$ . Using recent equations the total torque in the new motor structure can be precisely calculated by using only single two-dimensional FEM analysis which determine  $T(\theta)$ . Equation (5) approximately can be rewritten as

$$T_{tot}(\theta) = \sum \tau_z(\theta) \Delta z \quad (8)$$

The motor total torque may be calculated using Eq. (5) and Eq. (8). Considering 10 divisions in Eq. (8), the error between them is less than 4 percent for the proposed skewed rotor pole SRM. A similar method may be used for calculating other parameters in this way. Some parameters of the proposed SRM are summarized in Table 1.

It must be noted that magnetic saturation in SRMs is an unavoidable phenomenon and must be considered in torque calculations. Recent equation is precise mathematically but magnetic saturation is not considered.

**Table 1** Specification of Skewed Rotor Pole SRM.

Symbol	Quantity	Values
$D_0$	Stator outer diameter	189.4 mm
$D_s$	Stator inner diameter	147.0 mm
$D$	Rotor outer diameter	89.57 mm
$D_r$	rotor inner diameter	52.89 mm
$D_{sh}$	Shaft diameter	30.0 mm
$l$	Motor stack length	89.92 mm
$g$	Air gap	0.4 mm
$B_r$	Rotor initial pole arc	27.44°
$B_s$	Stator initial pole arc	17.30°
$N$	Phase winding turns	260
$I_{max}$	Maximum phase current	10 A

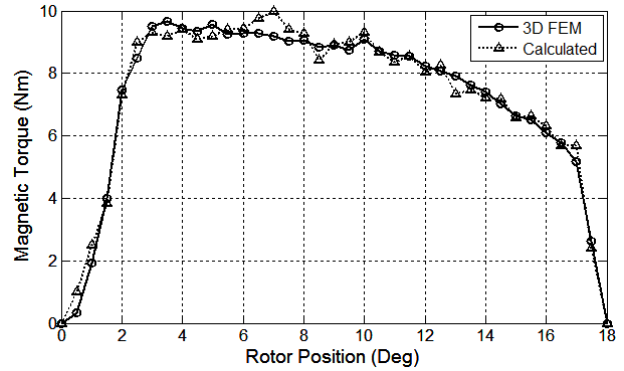

**Fig. 4** Illustration of phase torque for proposed SRM

Therefore, by using of Eq. (8), the proposed SRM is divided into larger sections and two-dimensional FEM is individually applied to each one considering magnetic saturation. The resultant phase static torque is shown in Fig. 4.

According to Fig. 4, the mean value of torque is 7.17 Nm for proposed structure and its value for conventional one is 7.16 Nm. Therefore, the torque power is not changed considerably while the motor volume is properly reduced. FEM results show that radial force in the proposed design is reduced but motional force is not considerably changed in comparison to conventional design. It must be noted that three-dimensional analysis is added into Fig. 2 to validate modeling and calculation results.

#### 4 Analysis Results and Comparisons

As explained in the previous section, the skewed rotor pole SRM is analyzed using an approximate two-dimensional FEM to detect some available characteristic for the new design. Therefore, the motor geometry is divided into several sections and FEM results are subtracted. Finally, the whole section results, predict the motor performance. At first, a three-dimensional model simulation is used to verify the accuracy of approximated two-dimensional model. Flux or

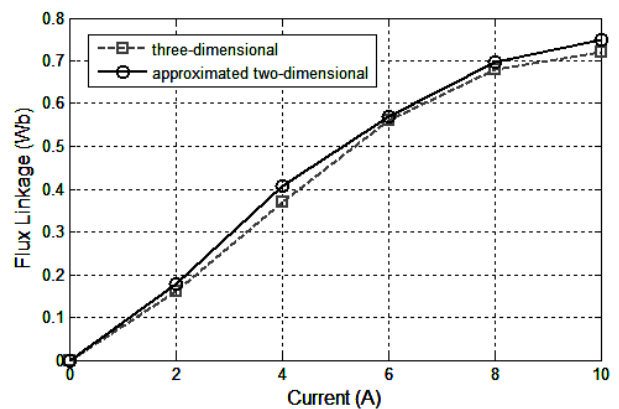

**Fig. 5** Comparison of flux measurement in two- and three-dimensional FEM.

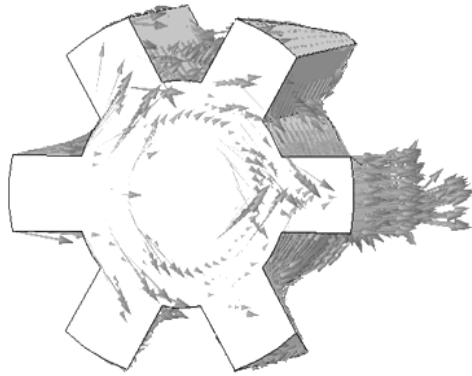

Fig. 6 Flux vector plot of three-dimensional FEM.

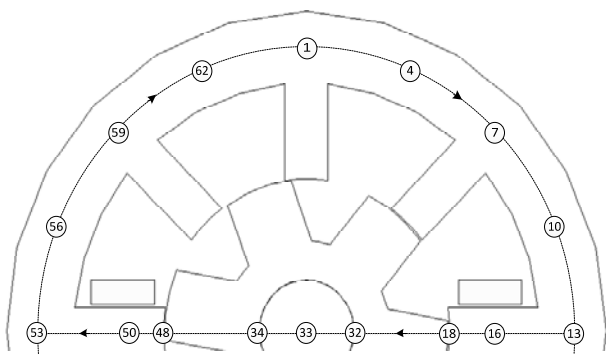
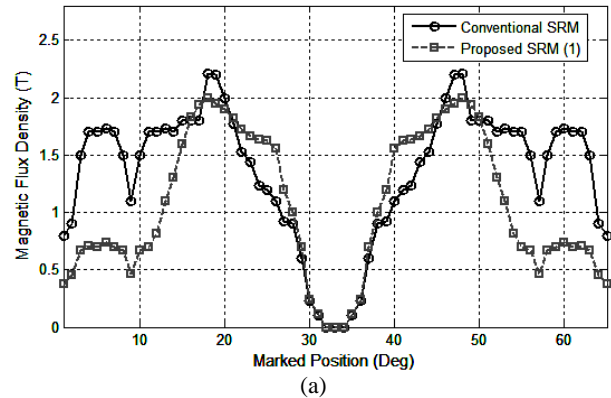

Fig. 7 Magnetic flux numbered path for SRM phase.

inductance in terms of current or position was routinely used in some papers [13, 14] to make a good comparison in FEM results. Therefore, the flux linkage calculation of both methods with respect to current are performed in this paper and shown in Fig. 5. The results are similar because the majority of total flux is radial in 3D FEM. Flux vectors are also plotted in Fig. 6. It should be noted that the three-dimensional simulation takes several days to obtain desired curves while the approximated two-dimensional simulation makes its calculation easier.

The magnetic flux path from one phase with some position numbers is shown in Fig. 7. Magnetic flux density is calculated on this path in two steps. In the first step, the stator back iron thickness is not changed but in the second step, its value is split. Fig. 8(a) shows the magnetic flux density in the first step. Magnetic flux density for skewed rotor pole SRM in the stator back iron (positions numbered 1-13 and 53-66) is reduced in comparison to conventional one but its value not changed considerably on the other regions. That is why in the new design the motor stator back iron can be reduced. Thus, the reduced stator back iron for proposed design is considered and magnetic flux density is shown in Fig. 8(b). It is clear that the stator back iron reduction in the skewed rotor pole SRM has not considerable effect on the magnetic flux density.



(a)

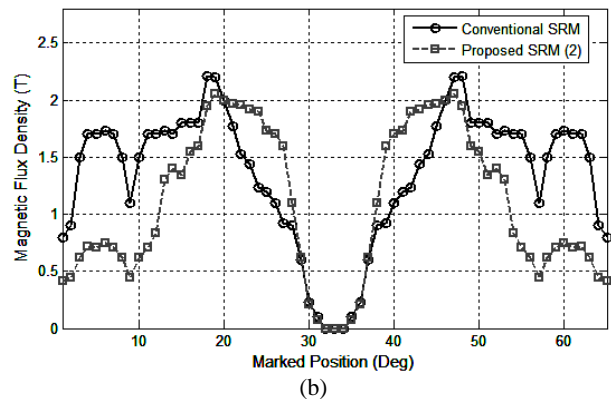

(b)

Fig. 8 Magnetic flux density on the magnetic phase path with (a) equal and (b) reduced stator back iron for proposed SRM.

When two or more phases are conducting simultaneously, the flux paths from each phase share sections of laminations, leading to saturation and lower permeabilities in localized regions of steel, or conversely to reduction in flux density in the steel and increased permeability. Thus, low magnetic saturation in stator back iron region makes the skewed rotor pole SRM suitable for mutual excitation.

The torque production and magnetization characteristics of switched reluctance motor are normally represented by area enclosed by current/flux linkage trajectory and by per phase static magnetization curves respectively [15, 16]. The areas of flux/current loci are directly related to torque production. Therefore, the flux/current characteristics are analyzed for the new design. Fig. 9 shows the flux linkage as a function of current for one phase of the proposed and conventional SRM. Near aligned positions, phase switch is turning off and near unaligned positions, switch is turning on. Between these, some control strategies may be employed such as current control. Fig. 9(a) shows flux/current in the low current regime with reduced back iron. The flux/current area enclosed with the conventional SRM loci produce more torque in comparison to area enclosed with the proposed SRM. In the high current regime as shown in Fig. 9(b), skewed rotor pole and conventional SRM have a similar

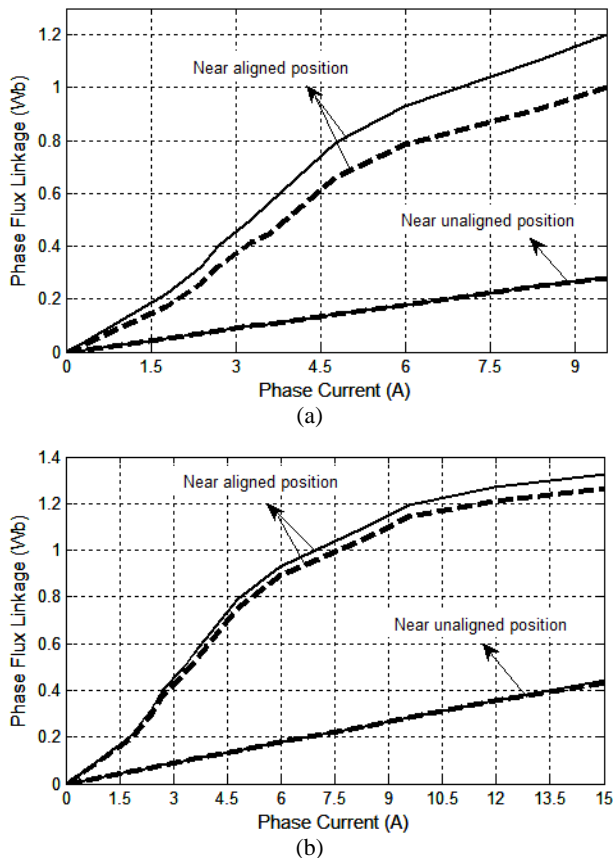

**Fig. 9** Flux/current characteristics for conventional (solid line) and proposed design (dashed line) in (a) low current regime with reduced back iron, and (b) high current regime.

characteristic. In the second regime, the phase current is high thus for the conventional SRM, the motor wants to be saturated in earlier positions but in the proposed SRM, because of its structure, the motor total saturation is occurred later. Therefore, both new and conventional SRM approximately have same maximum flux as shown in Fig. 9(b) and their torque production performance is similar.

In this paper, comparisons are done with a classical rotor design, which teeth are as wide as the teeth in the new design. A comparison with classical rotor which teeth are as wide as the average tooth-width in the new design may be more reasonable but this rotor has a less performance in terms of torque production and saturation characteristics [17]. In other words, smaller rotor teeth cannot improve the efficiency. Therefore, the previous comparisons strongly validate the new design. In terms of reduction in the motor volume and weight, two geometry changes are occurred in the rotor pole and stator back iron. The rotor pole volume is reduced to its half value and then the motor weight is decreased about 8 % in comparison to conventional design. However, this has no effect on the motor total volume. Based on the mentioned analysis in the previous section, the stator back iron can be decreased in the proposed design. This

results in reduction both in the motor volume (6.7 %) and weight (9 %). It should be noted that the iron loss in the proposed structure is similar to that of conventional one. In the new structure, saturation in the tips of salient poles is considerable and at the same time the saturation in the back iron is decreased as explained. On the other side, the motor structure in the proposed form is also laminated and thus the iron loss can be neglected. In total, because of the same losses in the proposed and conventional design, the efficiency is not changed.

## 5 Conclusions

This paper presented a new SRM with skewed rotor pole. The proposed design improves magnetic saturation and flux/current characteristics in the motor phase. An approximated two-dimensional FEM was used to analysis the proposed design and some comparisons with three-dimensional FEM are also performed for validity. Lightweight, low volume and high power are some desired features needed in many applications. In the new design, Rotor and stator volume is decreased (total weight is decreased about 0.17 % and the motor volume about 6.7 %) while the motor power not changed considerably. Therefore, the proposed motor has high torque per volume in a similar speed. On the other side, the motor drive system for the proposed SRM is the same as in conventional one and is not complicated unlike recent designs in literatures. Taking these features into account, the new design is a suitable candidate for EVs and some other applications in which low volume as well as low weight are main concerns.

## References

- [1] M. Reza Feyzi, S. R. Mousavi-Aghdam and Y. Ebrahimi, "A comprehensive review on the performance improvement in switched reluctance motor design", in *2011 IEEE CCECE conf.*, pp. 348-353, 2011.
- [2] O. Seok-Gyu and R. Krishnan, "Two-phase SRM with flux-reversal-free stator: concept, analysis, and experimental verification", *IEEE Trans. Ind. Appl.*, Vol. 43, No. 5, pp. 1247-1257, Sep./Oct. 2007.
- [3] M. Asgar and E. Afjei, "A new class of resonant discharge drive topology for switched reluctance motor", *Iranian Journal of Electrical & Electronic Engineering.*, Vol. 5, No. 4, pp. 261-269, Dec. 2009.
- [4] M. Abbasian, M. Moallem and B. Fahimi, "Double-stator switched reluctance machines (DSSRM): fundamentals and magnetic force analysis", *IEEE Trans. Energy Conversion*, Vol. 25, No. 3, pp. 589-597, Sep. 2010.
- [5] M. Shang-Hsun and T. Mi-Ching, "A novel switched reluctance motor with C-core stator", *IEEE Trans. Magn.*, Vol. 41, No. 12, pp. 4413-4420, Dec. 2007.

- [6] C. Lee and R. Krishnan, "New designs of a two-phase E-core switched reluctance machine by optimizing the magnetic structure for a specific application: concept, design and analysis", *IEEE Trans. Ind. Appl.*, Vol. 45, No. 5, pp. 1804-1814, Sep./Oct. 2009.
- [7] C. Elmas and T. Yigit, "Genetic algorithm based on-line tuning of a PI controller for a switched reluctance motor drive", *Electric power components and systems*, Vol. 35, No. 6, pp. 675-691. 2007.
- [8] M. M. Namazi Isfahani, A. Rashidi and S. M. Saghaian-Nejad, "Energy-based adaptive sliding mode speed control for switched reluctance motor drive systems", *Iranian Journal of Electrical & Electronic Engineering.*, Vol. 8, No. 1, pp. 68-75, Mar. 2012.
- [9] H. Torkaman, E. Afjei and M. S. Toulabi, "New double-layer-per-phase switched reluctance motor: concept, numerical analysis, and experimental verification", *IEEE Trans. Ind. Appl.*, Vol. 59, No. 2, pp. 830-838, Feb. 2012.
- [10] M. Ehsani, Y. Gao and A. Emadi, *Modern Electric, Hybrid Electric and Fuel Cell Vehicles*, CRC Press, 2010.
- [11] C. Choi, D. Lee and K. Park, "Fuzzy design of a switched reluctance motor based on the torque profile optimization", *IEEE Trans. Magn.*, Vol. 36, No. 5, pp. 3548-3550, Sep. 2000.
- [12] S. R. Mousavi-Agham, M. Reza Feyzi, and Y. Ebrahimi, "A new switched reluctance motor design to reduce torque ripple using finite element fuzzy optimization", *Iranian Journal of Electrical & Electronic Engineering.*, Vol. 8, No. 1, pp. 91-96, Mar. 2012.
- [13] I. Husain and S. A. Hossain, "Modeling, simulation and control of switched reluctance motor drives", *IEEE Trans. Ind. Elect.*, Vol. 52, No. 6, pp. 1625-1634, 2005.
- [14] C. Lee, R. Krishnan, and N. S. Lobo, "Novel two-phase switched reluctance machine using common-pole E-core structure: concept, analysis, and experimental verification", *IEEE Trans. Ind. Appl.*, Vol. 45, No. 2, pp. 703-711, 2009.
- [15] B. C. Mecrow, E. A. El-Kharashi, J. W. Finch, and A. G. Jack, "Preliminary performance evaluation of switched reluctance motors with segmental rotors", *IEEE Trans. Energy Conversion*, Vol. 19, No. 4, pp. 679-686, Dec. 2004.
- [16] B. C. Mecrow, E. A. El-Kharashi, J. W. Finch, and A. G. Jack, "Segmental rotor switched reluctance motors with single-tooth windings", *IEE Proc.-Electr. Power Appl.*, Vol. 150, No. 5, pp. 591-599, Sep. 2003.
- [17] J. Faiz and J. W. Finch, "Aspects of design optimization for switched reluctance motors", *IEEE Trans. Energy Conversion*, Vol. 8, No. 4, pp. 704-713, Dec. 1993.



**Seyed Reza Mousavi-Aghdam**

received his B.Sc. degree with first class honors in Electrical Power Engineering from Azarbaijan University of Shahid Madani in 2009, Tabriz, and M.Sc. Degree from University of Tabriz with honor in 2011. He is currently working toward the Ph.D. degree in the University of Tabriz. His current

research interests include design of electrical machines, electric drives and analysis of special machines.



**Mohammad Reza Feyzi**

received his B.Sc. and M.Sc. in 1975 from university of Tabriz in Iran with honor degree. He worked in the same university during 1975 to 1993. He started his Ph.D. work at the University of Adelaide, Australia in 1993. Soon after his graduation, he rejoined to the University of Tabriz. Currently, he is a professor in the same

university. His research interests are finite element analysis, design and simulation of electrical machines and transformers.