

# Leakage Current Analysis of Polymer and Porcelain Housed Metal Oxide Surge Arresters in Humid Ambient Conditions

K. Mokhtari\*, M. Mirzaie<sup>\*(C.A.)</sup> and M. Shahabi\*

**Abstract:** This paper aims to measure and analyze of the leakage current of 20 kV polymer and porcelain metal oxide surge arresters under humid ambient conditions by applying different voltages to the arresters terminal. The characteristics of the leakage currents at that stage have been investigated when changes in the ambient humidity were introduced in an artificial fog chamber. It is assumed that magnitude of the noise level during the tests is constant. The frequency and resistive component peak efficient analysis can then be done on the leakage current signal. The idea behind this is to get indicators for investigating of surge arrester behavior in humid conditions. Two important indicators were obtained to evaluate the behavior of the surge arrester in humid conditions.

**Keywords:** FFT Amplitude, Humidity, Leakage Current, Metal Oxide Surge Arrester.

## 1 Introduction

Lightning and switching surges and also temporary overvoltages are the main reasons for outages in overhead transmission lines, distribution lines and in substations such as UHV GIS [1]. Metal-Oxide (MO) surge arresters is an important overvoltage protection device in power systems [2], that frequently being used in power transmission and distribution facilities for surge protection of equipment. Today, there are several different types of surge arresters and all perform in a similar manner. Most distribution surge arrester types have polymeric or porcelain housing and a mechanical structure without spark gaps. Surge arresters are known that nonlinear voltage-current characteristics of metal oxide varistors become degraded due to the continuous application of AC or due to transients with currents larger than the varistors ratings. In addition MO arresters are inherently faster-acting than the gapped type, since there is no time delay due to series air gaps extinguishing the current [3].

The MO surge arresters can degrade during its service due to passage of surge currents, moisture ingress, pollution on the external surface, and overvoltages. Thus, is obvious the importance of the arresters' condition monitoring, since this process is capable to guarantee the reliability of the system.

Nowadays, the determination of the condition of

gapless MO arresters is achieved using many alternative methods, such as ultrasonic and radio interference detection [4], partial discharge and electromagnetic radiation measurement [5, 6], thermovision methods [7] and certainly the leakage current measurement. As it has already been mentioned earlier, the majority of diagnostic methods are based on the measurements of the leakage current. The total leakage current of a MO surge arrester consist of resistive and capacitive current components, where the capacitive component is much bigger than the resistive. Increase of the applied voltage and the increase of ambient temperature, degradation or aging in the arrester results in an increase to the resistive component of the leakage current, while the capacitive part has little change [8-10]. An increase of the resistive current can be considered as an indicator of the arresters condition, and with the continued operation time it can cause failures or permanent degradation [11]. The leakage current measuring procedures can be divided into two different groups [12], Online monitoring and offline monitoring. Offline measurements can be performed with voltage sources that are specially suited for this purpose, for example, mobile AC or DC test generators. Good accuracy may be obtained by using the offline methods, provided that a sufficiently high test voltage is used.

The direct measurement can be performed using a reference voltage signal (a procedure that demands simultaneous measurement of the voltage) or by an appropriate compensation method. The third harmonic analysis [12], which does not need reference voltage signal, is based on the fact that the leakage current contains harmonics, due to the nonlinearity of the

---

Iranian Journal of Electrical & Electronic Engineering, 2015.

Paper first received 7 Nov. 2014 and in revised form 18 Dec. 2014.

\* The Authors are with the Department of Electrical and Computer Engineering, Babol University of Technology, Babol, Iran.

E-mails: k.mokhtari@stu.nit.ac.ir, mirzaie@nit.ac.ir and shahabi.m@nit.ac.ir.

voltage–current characteristic. When the resistive current increases, the amplitude of the harmonics also increases. However, resistive current detection diagnostic methods have been improved and many researchers have presented advanced methods and convenient instruments [11, 13-16].

Several leakage current measurements exist in the technical literature performed under artificial pollution conditions [14, 17].

Christodoulou et al. [18] done the measurements under artificial rain and measurements after impulse voltage subjection. No attempt was made to determine leakage current harmonics.

Lahti et al. [19] considered based on measurement results obtained during a 1.5 year laboratory test series conducted for different types of polymer-housed distribution class arresters. This work was done for revealing internal moisture in polymer housed metal oxide surge arresters. No attempt was made to determine leakage current harmonics of brand new surge arrester in different humidity conditions.

Mardira et al. [20] investigated diagnostic techniques for metal oxide surge arresters when subjected to severe lightning strikes in the field. In this work leakage current harmonics analysis was not attempted as a diagnostic methods.

In this work, the characteristics of leakage current in the time and frequency domain were measured and analyzed, Fast Fourier Transform (FFT) amplitude and the resistive component of the leakage current is measured, using a voltage reference signal.

Two different cases for the surge arresters with polymeric and porcelain housing were considered, that is, measurements with brand new arresters, measurements under different humidity ranges and measurements with different applied voltage. The purpose of two kinds of Metal Oxide Surge Arresters being taken as samples is to select suitable arrester for areas with high humidity. It must be mentioned that this work has been focused on tests in humid ambient. The behavior of leakage current's harmonic components and resistive component during these tests has been presented in detail since moisture on polymeric and porcelain housing of arrester, plays an important role in arrester's condition. The analysis and the discussion of the produced results can be used from electric utility's engineers in order to easily diagnose arresters' condition leading to more effective schedule maintenance.

## 2 Experimental Tests

### 2.1 Test Facilities

In order to perform the experimental tests, the setup has been prepared according to IEC 60507, IEC 60060-1 & 60060-2 and IEC 60099-4, as shown in Figs. 1 and 2. The tests were performed in a fog chamber in the high voltage laboratory of Babol University of Technology. This chamber has the volume equal to 200

cm×200 cm×180 cm, as shown in Fig. 3. The test circuit is shown in Fig. 1.

The high voltage supply is connected to tested surge arresters through a 10 MΩ, protective resistance (R1). Also, the HV supply is connected to a capacitor voltage divider (C.V.D) with the ratio of 250:1 (high voltage to low voltage). AC voltage up to  $25 \text{ kV}_{\text{rms}} \div \sqrt{3} = 14.4 \text{ kV}_{\text{rms}}$  was applied to the sample surge arrester. Digital oscilloscope (D.O) acquired the voltage waveform from the low voltage of C.V.D.

The leakage current waveform is measured from voltage drop across a specific resistor R1 (470 Ω) by D.O. All of the waveforms and their FFT are recorded and stored by D.O. Fig. 4 shows an example of leakage current and applied voltage waveform recorded by oscilloscope.

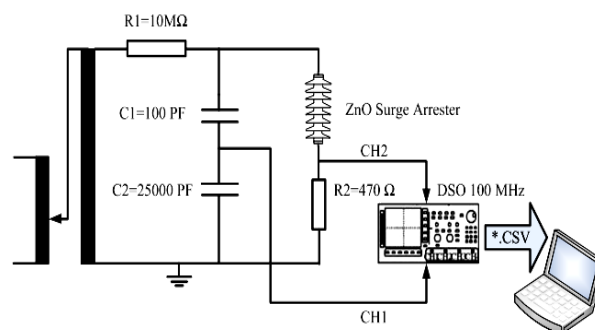

**Fig. 1** Circuit for the measurement of the total leakage current of a surge arrester.



**Fig. 2** Experimental setup in laboratory.



**Fig. 3** Fog chamber for experimental tests.

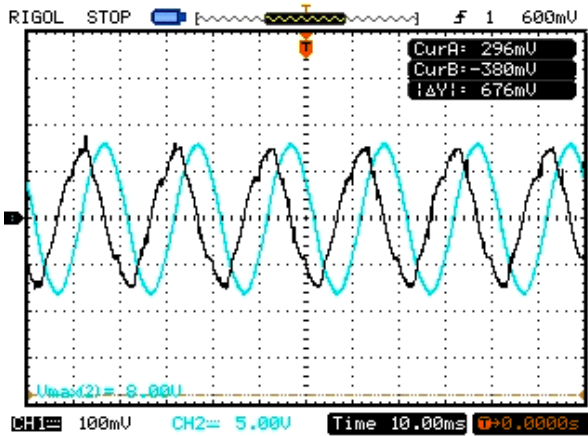

**Fig. 4** Example of leakage current and applied voltage waveform recorded by oscilloscope.

## 2.2 Power Supply

AC high voltage is supplied to 100 kV from single phase transformers 220 V/100 kV, 5 kVA, 50 Hz. The rated current of each transformer is 50 mA with maximum short circuit of 1.25 A. The HV supply was connected to the test chamber through a vertical bushing. The power supply is leaded sample surge arrester through a resistance.

## 2.3 Sample Surge Arresters

The sample arresters were used for the experiments includes 8 sheds for polymer and 6 sheds for porcelain surge arrester. These surge arresters are used for simulating 20 kV distribution lines. Their parameters are shown in Table 1.

## 2.4 Test Procedure

In the current work, the leakage current for two 20 kV ZnO polymer and porcelain housed surge arresters was computed for four humidity different cases in three voltage levels.

**Table 1** Electrical and housing data characteristics of the arresters.

Parameters	Silicon Rubber	Porcelain
Nominal discharge current (8/20 $\mu$ s), kA	10	10
Residual voltage (8/20 $\mu$ s, 10 kA), kV	82	75
Height, mm	380	460
Creepage distance, mm	850	485
Number of sheds	8	6

In order to measure leakage current resistive and harmonic components of surge arresters, all surge arresters were tested in humid conditions. In any humidity level, the surge arresters were energized with three voltage levels in clean fog produced by fog generators.

The relative humidity of the air was kept in four ranges, (55–65%), (65–75%), (75–85%) and (85–95%), respectively. The temperature range of the fog chamber was kept constant, between 20 and 25°C, during test series described below:

For each arrester and for each humidity range, five measurements in 11.5 kV (corresponds to the continuous operating voltage of the arrester ( $U_c$ )), five measurements in 13.2 kV and five measurements in 14.4 kV (corresponds to the rated voltage of the arrester ( $U_r$ )) were performed.

However, in this work, resistive and harmonic components of ZnO polymer and porcelain arresters under different humidity condition are discussed and analysed. The study of these measurements could be useful in the more effective evaluation of the arresters' condition.

In humid condition, clean fog produced by fog generator and as soon as the arrester surface was wetted for 15–20 min, the operating voltage was applied. In each of the cases, leakage current signals were recorded and analysed in both time-domain and frequency-domain.

Fig. 5 shows a flowchart of the measurement and analyzing procedure of surge arresters' leakage current to obtain indicators that are effective in determining the condition of arresters.

## 3 Analysis of the Leakage Current

Fourier series provides an alternate way of representing data, instead of representing the signal amplitude as a function of time, was represented the signal by how much information is contained at different frequencies. The leakage current is a random signal in nature that follows the statistical laws in the time domain and represents the harmonic feature in the frequency domain.

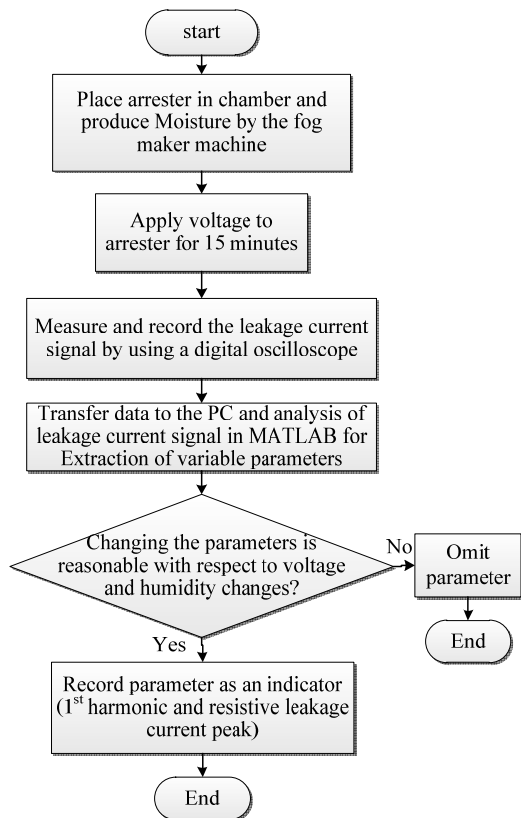

**Fig. 5** flowchart of the measurement and analyzing procedure of surge arresters' leakage current

The FFT analysed characteristics of the leakage current can be used as another new approach to explore the influence of relative humidity, on the leakage

current. In laboratory tests, the applied voltage and total leakage current waveforms were measured with use of oscilloscope, the voltage waveform is considered as reference signal.

The resistive current was the value of the total current at the instant when the voltage was at its peak. This method is commonly used in laboratories for accurate determination of the resistive current, since the reference signal is easily accessible through a voltage divider having a sufficiently small phase shift. In practice, the accuracy is limited mainly by the phase shift of the reference signal and by the deviations in magnitude and phase of the voltage across the nonlinear MO resistors at the earthed end of the arrester. The presence of harmonics in the voltage may further reduce the accuracy of the method. A restriction on the method during online measurements is the need of a reference signal [18].

## 4 Result and Discussion

### 4.1 Leakage Current Waveforms and Frequency Spectrum Analysis

The characteristics of leakage currents in the humidity experiments can be demonstrated by the waveforms, FFT amplitudes plots. The Stored waveforms by oscilloscope are in the form of \*.CSV files and they can be used to obtain leakage current frequency spectrum in MATLAB environment. Figures 6 and 7, show waveforms and frequency spectrum of leakage current for polymer and porcelain surge arrester in 11.5 kV voltage level when the relative humidity was in different humidity ranges.

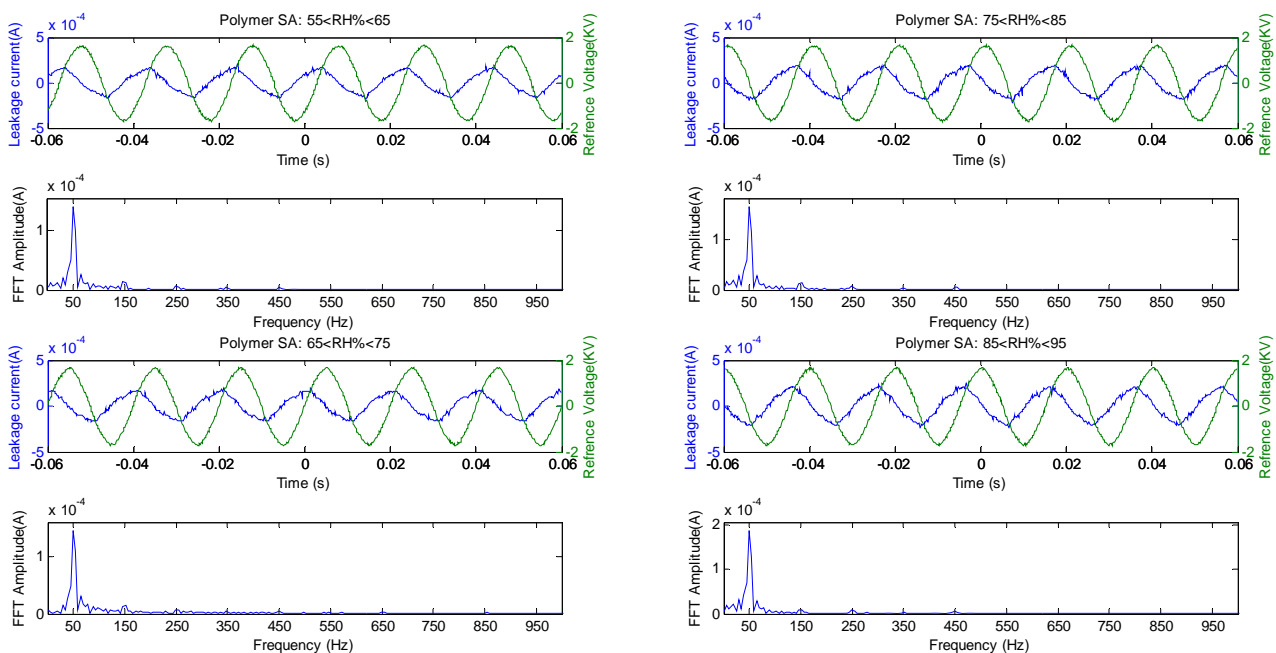

**Fig. 6** Waveforms, FFT amplitudes for polymer surge arrester in 11.5 kV level and in different relative humidity ranges (RH%).

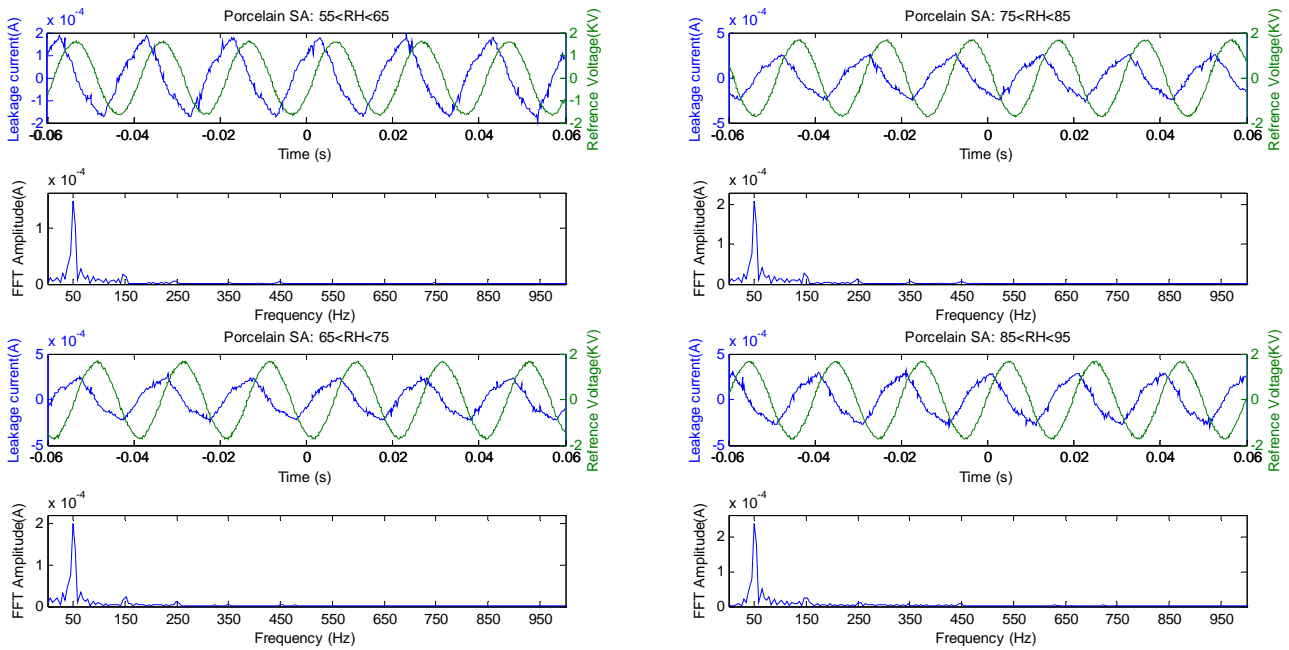

**Fig. 7** Waveforms, FFT amplitudes for porcelain surge arrester in 11.5 kV level and in different relative humidity ranges (RH%).

Table 2 shows the average amplitude of harmonic components of leakage current for each humidity and voltage level. According to the table, the increase is not same for the other harmonic components such as, for 150 and 250 Hz. Their analysis reveals that the growth of the 50 Hz harmonic component is the main reason for the increase of the leakage current with relative humidity.

Inspecting the amplitude plots, the smooth lines show that there are only a few pulses during the entire test process. Since the conductivity on the porcelain arrester surface is rather high in comparison to polymer arrester in different relative humidity condition, the resistive currents must be dominant when the total energy mainly concentrates in the low frequency range. Thus, the reason for the increase of the leakage current is mainly because of the increase of the relative

humidity, considering the characteristics of the leakage current from the waveforms, FFT amplitudes.

#### 4.2 Leakage Current Resistive Component

Figs. 6 and 7 show applied voltage and leakage current Waveforms for polymer and porcelain surge arrester in 11.5 kV level and in different relative humidity ranges. As it can be seen in these figures, the current curves, due to noise and electromagnetic interference haven't a sinusoidal perfect form. Assuming constant magnitude of the noise level during the tests makes the results comparable. The electromagnetic noise affects significantly the accuracy of the measurements and this is more intense when the test is performed online in a distribution line or in a substation, where the noise level is much higher and not constant [18].

**Table 2** Average amplitude of leakage current in micro ampere ( $\mu\text{A}$ ) for polymer and porcelain surge arrester in different voltage level (rms)

Relative Humidity (RH%)	Material	Applied Voltage (kV)								
		11.5			13.2			14.4		
		1st	3rd	5th	1st	3rd	5th	1st	3rd	5th
55-65%	polymer	141.1	14.53	5.98	161.2	12.34	9.48	187.2	13.21	14.32
	porcelain	150.2	17.77	5.61	171.6	15.61	12.56	191.9	13.42	15.61
65-75%	polymer	153.6	14.33	7.72	172.3	13.78	15.12	191.6	16.93	11.21
	porcelain	201.5	23.58	11.26	209.6	17.28	10.42	221.5	15.61	14.72
75-85%	polymer	166.9	15.8	7.45	175.8	14.97	13.53	200.8	17.21	15.63
	porcelain	209.7	26.04	11.5	231.5	16.82	17.67	249.2	22.94	19.76
85-95%	polymer	186.2	9.85	7.43	180.2	18.34	11.79	216.2	19.73	13.29
	porcelain	236.7	25.18	13.67	251.9	24.71	15.91	281.3	20.32	19.55



**Table 3** Computed resistive currents for porcelain arrester.

Applied AC voltage (kV)	RH%: (55-65)	RH%: (65-75)	RH%: (75-85)	RH%: (85-95)
	Resistive leakage current (μA)			
11.5	2.8112	15.972	29.368	38.644
13.2	5.7608	19.682	31.534	47.714
14.4	5.628	20.834	35.2	55.36

**Table 4** Computed resistive currents for polymer arrester.

Applied AC voltage (kV)	RH%: (55-65)	RH%: (65-75)	RH%: (75-85)	RH%: (85-95)
	Resistive leakage current (μA)			
11.5	2.721	8.6006	15.792	24.792
13.2	3.0922	11.7242	23.154	28.084
14.4	5.5396	15.086	28.338	34.92

Tables 3 and 4 show the average computed resistive leakage currents for each humidity and voltage level. An average value of the resistive leakage current from five measurements was computed based on oscilloscope's waveform.

Figs. 8-10 show the percentage increase of the resistive leakage current for two surge arrester after the normal humidity range (55-65%) in another different humidity ranges and applied AC voltage levels, according to the equation:

$$\text{Increase}(\%) = \frac{I_{\text{Humidityrange}_i} - I_{\text{NormalHumidity}}}{I_{\text{NormalHumidity}}} \quad (1)$$

where  $I_{\text{Humidityrange}_i}$  is the measured resistive current of the  $i$ th humidity range and  $I_{\text{NormalHumidity}}$  is the measured resistive current in (55-65%) humidity range.

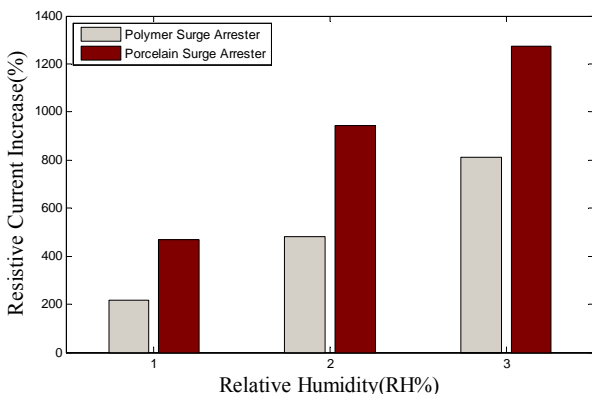

**Fig. 8** Resistive leakage current increase measured in two Surge arresters in 11.5 kV applied voltage (x-axis: 1, corresponds to RH% range (65-75%); 2, corresponds to RH% range (75-85%) and 3, corresponds to RH% range (85-95%)).

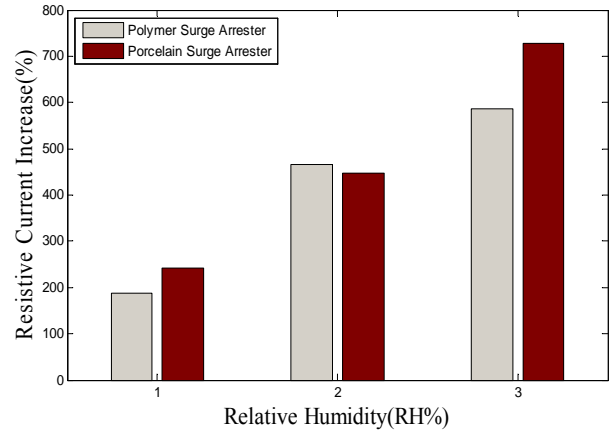

**Fig. 9** Resistive leakage current increase measured in two Surge arresters in 13.2 kV applied voltage (x-axis: 1, corresponds to RH% range (65-75%); 2, corresponds to RH% range (75-85%) and 3, corresponds to RH% range (85-95%)).

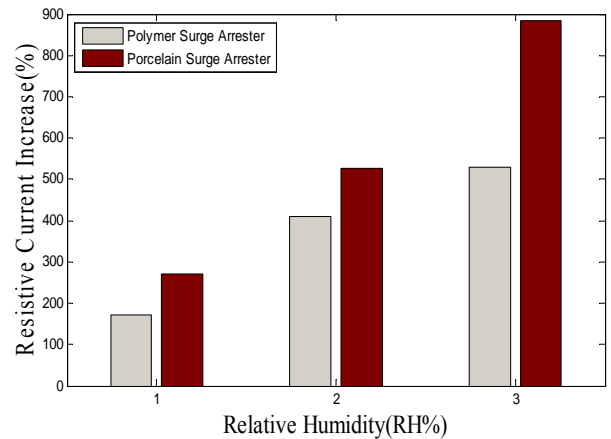

**Fig. 10** Resistive leakage current increase measured in two Surge arresters in 14.4 kV applied voltage (x-axis: 1, corresponds to RH% range (65-75%); 2, corresponds to RH% range (75-85%) and 3, corresponds to RH% range (85-95%)).

As it was expected, the increase of the measured resistive leakage current is due to the increase of the AC voltage between the arrester terminals. During the humid test the resistive current increases for each two surge arrester.

The increase of the resistive current under the humidity conditions is owed to the humid drops in the polymeric and porcelain arrester's surface. By increasing humidity, resistive leakage current increases in both surge arresters.

The results show that measured resistive leakage currents for porcelain surge arrester in corresponding states, is greater than polymer surge arrester, since it is shown that higher than polymer surge arrester resistive current values can be due to differences in two surge arresters housing material.

## 5 Conclusions

In the present work, the resistance leakage current and leakage current frequency spectrum analysis for two 20 kV ZnO surge arresters with polymeric and porcelain housing was computed for three voltage levels in four humidity ranges (measurements on brand new arresters, measurements under humidity conditions). By analyzing harmonic component of leakage current, we find out that, in humid ambient conditions, amplitude of first harmonic order increases with increase in humidity. It is noted that first harmonic order is more sensitive to change in humidity in comparison with higher harmonic order. On the other hand, leakage current resistive component increases in humid ambient conditions. Increase in harmonic component of leakage current and its resistive component for porcelain arresters is more comparing to polymer arresters. These two components can be good indicators for evaluating arresters in humid ambient conditions.

## References

- [1] X. Zhang and J. He, "Lightning overvoltage suppression to UHV power transformer by ferromagnetic ring", *Electr. Power Syst. Res.*, Vol. 94, pp. 122-128, 2013.
- [2] Z. N. Xu, L. J. Zhao, A. Ding and F. C. Lü, "A Current Orthogonality Method to Extract Resistive Leakage Current of MOSA", *IEEE Transaction on Power Delivery*, Vol. 28, No. 1, pp. 93-101, 2013.
- [3] R. E. James and Q. Su, *Condition Assessment of High Voltage Insulation in Power System Equipment*, IET Digital Library, 1st ed. 2008.
- [4] H. R. P. De Oliveira, M. L. B. Martinez, I. G. Campos and R. G. de Oliveira, C. de Salles and C. Lefort, "New techniques for field inspection of medium voltage surge arresters", *IEEE Conf. Power Tech.*, pp. 39-44, Lausanne, 2007.
- [5] K. L. Wong, "Electromagnetic emission based monitoring technique for polymer ZnO surge arresters", *IEEE Trans. Dielectr. Electr. Insul.*, Vol. 13, No. 1, pp. 181-190, 2006.
- [6] K. Lahti, P. Pakonen, K. Kannus and K. Nousiainen, "Possibilities to reveal internal moisture in polymeric metal oxide surge arresters by means of PD and EMR measurements", *IEEE Int. Conf. Elect. Power Eng.*, p.100, Budapest, Aug. 1999.
- [7] C. Heinrich and V. Hinrichsen, "Diagnostics and monitoring of metal-oxide surge arresters in high-voltage networks comparison of existing and newly developed procedures", *IEEE Trans. Power Deliv.*, Vol. 16, No. 1, pp. 138-143, 2001.
- [8] J. N. Lin, C. M. Lin, C. C. Kao and W. C. Chang, "Electrical properties and degradation phenomena of glass-doped ZnO chip varistors", *Mater. Sci. Eng. B*, Vol. 20, No. 3, pp. 261-265, 1993.
- [9] M. Oyama, I. Ohshima, M. Honda and M. Yamashita, "Life performance of zinc-oxide elements under DC voltage", *IEEE Transaction on Power Appar. Syst.*, Vol. PAS-101, No. 6, pp. 1363-1368, 1982.
- [10] M. Matsuoka, "Nonohmic properties of zinc oxide ceramics", *Jpn. J. Appl. Phys.*, Vol. 10, No. 6, pp. 736-746, 1971.
- [11] H. Zhu and M. R. Raghuveer, "Influence of harmonics in system voltage on metal oxide surge arrester diagnostics", *Annual Report Conference on Electrical Insulation and Dielectric Phenomena*, Vol. 2, pp. 542-545, 1999.
- [12] IEC 60099-5 Standard, *Surge arresters-Part 5: selection and application recommendations*, 2013.
- [13] B. Biglar, S. Jayaram and E. A. Cherney, "Evaluation of the insulation design of polymer housed surge arresters using salt-fog test", *Annual Report Conf. Electrical Insulation and Dielectric Phenomena*, Vol. 1, pp. 385-388, 2000.
- [14] K. Chrzan, Z. Pohl, S. Grzybowski and W. Kohler, "Pollution performance of 110 kV metal oxide arresters", *IEEE Transactions on Power Delivery*, Vol. 12, No. 2, pp. 728-733, 1997.
- [15] S. Shirakawa, F. Endo, H. Kitajima, S. Kobayashi, K. Goto and M. Sakai, "Maintenance of surge arrester by a portable arrester leakage current detector", *IEEE Transactions on Power Delivery*, Vol. 3, No. 3, pp. 998-1003, 1988.
- [16] J. Lundquist, L. Stenstorm, A. Schei and B. Hansen, "New method for measurement of the resistive leakage currents of metal-oxide surge arresters in service", *IEEE Trans. on. Power Delivery*, Vol. 5, No. 4, pp. 1811-1822, 1990.
- [17] H. Kado, K. Izumi, S. Shirakawa, K. Komatsu, H. Watanabe, M. Yamaguchi, M. Nakajima, M. Kobayashi and S. Nishimura, "Artificial pollution tests on porcelain-housed metal-oxide surge arresters for 275 kV power systems", *IEEE Power Engineering Society Winter Meeting*, Vol. 3, pp. 2087-2092, 2000.
- [18] C. A. Christodoulou, M. V. Avgerinso, L. Ekonomou., I. F. Gonos and I. A. Stathopoulos, "Measurement of the resistive leakage current in surge arresters under artificial rain test and impulse voltage subjection", *IET Science, Measurement & Technology*, Vol. 3, No. 3, pp. 256-262, 2009.
- [19] K. Lathi, K. Kannus and K. Nousiainen, "Diagnostic Methods in Revealing Internal Moisture in Polymer Housed Metal Oxide Surge Arresters", *IEEE Transactions on Power Delivery*, Vol. 17, No. 4, pp. 951-956, 2002.
- [20] K. P. Mardira, T. K. Saha and R. A. Sutton, "Investigation of diagnostic techniques for metal oxide surge arresters", *IEEE Trans. on Dielectrics Electrical Insulation*, Vol. 12, No. 1, pp. 50-59, 2005.



**Kazem Mokhtari** was born in Gonabad, Iran in 1987. He received the B.Sc. in Birjand University and M.Sc. degrees in electrical engineering from of Babol University of Technology, Iran in 2009 and 2013, respectively. His research interests are electrical insulation, HV systems and distribution engineering.



**Mohammad Mirzaie** was born in Ghaem Shahr, Iran in 1975. He Obtained B.Sc. and M.Sc. Degrees in Electrical Engineering from University of Shahid Chamran, Ahvaz, Iran and Iran University of Science and Technology, Tehran, Iran in 1997 and 2000 respectively and Ph.D. Degree in

Electrical Engineering from Iran University of Science and Technology in 2007. He worked as an Assistant Professor in the electrical and computer engineering faculty of Babol University of Technology since 2007. His research interests include life management of high voltage equipments, high voltage engineering, intelligence networks for internal faults assessment in equipments and studying of insulation systems in transformers, cables, generators, breakers, insulators, electrical motors and also overhead transmission lines.



**Majid Shahabi** was received the B.Sc. degree in electrical engineering from Tabriz University, Tabriz, Iran, in 1998, and the M.Sc. and Ph.D. degree both in power engineering from Tarbiat Modarres University, Tehran, Iran, in 2001 and 2010 respectively. He is currently with the Department of Electrical and Computer Engineering in

Babol University of Technology. His current research interests include power system transients and distribution system operation and control in the presence of embedded generation resources.