

# Control of Series Resonant Converter with Robust Performance Against Load and Power Circuit Components Uncertainties

A. Mohammadpour\*, H. Mokhtari\* and M. R. Zolghadri\*

**Abstract:** Robust performance controller design for duty-cycle controlled series resonant converter (SRC) is proposed in this paper. The uncertainties of the converter are analyzed with load variation and power circuit components tolerances are taken into consideration. Additionally, a nominal performance (NP)  $H_\infty$  controller is designed. Closed-loop system is simulated with Orcad and simulation results of robust controller are compared with  $H_\infty$  nominal performance controller. Although  $H_\infty$  nominal performance controller has better performance for nominal plant, the robust performance controller is advantageous in dealing with uncertainties.

**Keywords:** Robust control, Series Resonant Converter, Nominal Performance (NP), Robust Performance (RP).

## 1 Introduction

Nowadays power electronics converters are designed and manufactured with the emphasis on high power density, high efficiency, and low electromagnetic interface (EMI). To reduce the size of power supplies intended for use in modem equipment, it is desirable to increase the operating frequency to decrease the size of reactive components. Resonant converters are currently the object with prevalent interests among power conversion applications since high frequency operation with decreased switching losses can be achieved [1]-[3]. Control of switching power converters is necessary to regulate output voltage while robustly reject input variations in the presence of load and components uncertainties. Robust control theory allows the design of stabilizing controllers for plants that contain uncertainties.

In [4] a robust controller is designed for conventional variable frequency controlled SRC, where load variation was considered as unstructured uncertainty. Similar work on robust controller In [4] a robust controller is designed for conventional variable frequency controlled SRC, where load variation was considered as unstructured uncertainty. Similar work on robust controller design for parallel resonant converter is reported in [5]. In contrast, structured uncertainty is

used in [6] to account for load variation in a duty-cycle controlled SRC. These controllers ignore the uncertainties arising from power circuit component tolerances. Robust controller design for a one-cycle controlled full-bridge series-parallel resonant inverter is proposed in [7]. This controller achieves robust stability and NP using “*hinfsyn*” function in MATLAB.

This paper presents an  $H_\infty$  NP controller as well as a robust performance controller (RP) for SRC shown in Fig. 1. NP controller is designed using “*hinfsyn*” while “*dksyn*” is used to synthesize RP controller. For RP controller load uncertainty and power stage components uncertainties are taken into account using structured and unstructured uncertainty modeling, respectively. The  $\mu$  synthesis approach described in [9] is used here for RP controller design.

## 2 Robust Control Problem

The well-established robust control theories are based mostly on linear time invariant (LTI) models. To design the controller, it is therefore more desirable to use, instead of the original time-varying switched model, a LTI model of the undergoing converter. Averaged modeling technique is proposed in [6], [8] to derive small-signal model of SRC, and is summarized here.

The equivalent circuit of SRC and applied tank voltage waveforms is illustrated in Fig. 2. The non-linear state-space equations of SRC can be written as

$$L \frac{di}{dt} = v_s - v - \text{sgn}(i) \cdot v_0 \quad (1)$$

---

Iranian Journal of Electrical & Electronic Engineering, 2009.

Paper first received 11 July 2009 and in revised form 26 Oct. 2009.

\* The Authors are with the Department of Electrical Engineering, Sharif University of Technology, Tehran, Iran.

E-mails: [ali.mohammadpour@ee.sharif.edu](mailto:ali.mohammadpour@ee.sharif.edu), [Mokhtari@sharif.edu](mailto:Mokhtari@sharif.edu), and [zolghadr@sharif.edu](mailto:zolghadr@sharif.edu).



**Table 1** Specification of SRC for controller design and simulation

Parameter	Value
Tank inductor $L$	285 $\mu H$
Tank capacitor $C$	10 $nF$
Filter capacitor $C_f$	33 $\mu F$
Input voltage $V_g$	10 $V$
Output voltage $V_o$	5 $V$
Switching frequency $f_s$	84.85 $kHz$
PWM gain $B$	1/9
Duty cycle $D$	0.62
Load resistance $R$	20-70 $\Omega$

The generalized system,  $P$  is given by

$$P = \begin{bmatrix} F_1 & -F_1 G_{vg} & -F_1 Z_o & -F_1 G_{vd} B \\ 0 & 0 & 0 & F_2 \\ 1 & -G_{vg} & -Z_o & -G_{vd} B \end{bmatrix} \quad (10)$$

Performance weighting functions for controller design are chosen as

$$F_1(s) = 50 \times \frac{\left(1 + \frac{s}{1000}\right)}{\left(1 + \frac{s}{10}\right)} \quad (11)$$

$$F_2(s) = 10^{-4} \times \frac{\left(1 + \frac{s}{300}\right)}{\left(1 + \frac{s}{10^5}\right)} \quad (12)$$

The function “*hinfsvn*” in MATLAB obtains a 4<sup>th</sup> order controller. Applying hankel-norm based model reduction results in the following 2<sup>nd</sup> order transfer function,

$$K(s) = \frac{18.92s^2 + 1.312 \times 10^5 s + 8.881 \times 10^7}{s^2 + 3397s + 2.32 \times 10^4} \quad (13)$$

This controller is realized using op-amps, and then closed loop system is simulated in Pspice. Simulation results shown in Figs. 4, 5, and 6 demonstrate that controller achieves objectives of our design for nominal plant.

Fig. 4 illustrates output voltage waveform for step change in the reference signal. Reference signal and output response are displayed on the same diagram. It is apparent that output waveform tracks reference signal in a fast manner. Fig. 5 shows output response when load changes from 60  $\Omega$  to 31  $\Omega$ . Output voltage waveform for input voltage disturbance is depicted in Fig. 6 when input voltage changes from 10 V to 11 V and vice versa. Although the controller rejects disturbances for nominal plant, is not robust against disturbances in the presence of uncertainties. For example, Fig. 6(c) illustrates output voltage for a step change in the input line voltage from 5 V to 5.5 V when tank capacitor is changed to 10.8 nF.

## 4 Robust Performance Controller

### 4.1 Controller Design

A RP controller is designed to achieve tracking, line regulation, and load regulation considering following uncertainties in load and power stage components,

- 1) Load can vary over a wide range from 20 to 70  $\Omega$ ,
- 2) Inductors and capacitors are assumed to have a tolerance of 10%.

Load variation is modeled as structured uncertainty [6]. The load resistance can be expressed as an admittance form,

$$G_L = G_o + \Delta G = G_o + W\Delta, \quad \|\Delta\|_\infty < 1, \quad \Delta \in \Re \quad (14)$$

where  $G_o = 1/3$  and uncertainty weighting function  $W = 1/20 - 1/31 = 0.01824$  is used to obtain a normalized perturbation matrix with  $\|\Delta\|_\infty < 1$ .

The unstructured uncertainty analysis is used to obtain a simple uncertainty model with the use of a full complex perturbation matrix  $\Delta$ , where at each frequency,  $\Delta(j\omega)$  satisfying  $\Delta(j\omega) \leq 1$ . For a single-input single-output system, (15) gives the multiplicative uncertainty bound, where  $G_{vd}$ ,  $G_{vd0}$  and  $W$  represent the perturbed plant, nominal plant, and multiplicative uncertainty bounds, respectively. Thus, any members of satisfy (16)

$$g = \left\{ G_{vd} : \frac{|G_{vd} - G_{vd0}|}{|G_{vd}|} < |W| \right\} \quad (15)$$

$$G_{vd} = G_{vd0}(1 + \Delta W), \|\Delta\|_\infty < 1 \quad (16)$$

The difference function parameterizes the discrepancy between the nominal plant and the perturbation behavior of a real system. The uncertainties of the nominal plant model and disturbance dynamics model are analyzed in MATLAB. Fig. 7 shows the relative uncertainties of the nominal plant line to output transfer function  $G_{vg0}$  and disturbance plant with power circuit parameter variation. The relationship between the relative uncertainties and the plants component tolerances for  $G_{vd}$  and  $Z_o$  is plotted in Figs. 8 and 9. From the uncertainty analysis, the multiplicative input uncertainty weighting function can be found using functions such as “*lti2uss*”. Functions  $W_1$ ,  $W_2$ , and  $W_3$  are given in Eqs. (17)-(19) as the multiplicative input uncertainty weighting function for  $G_{vg}$ ,  $G_{vd}$ , and  $Z_o$ , respectively. A simple second order weighting function is used to keep the shape of the nominal plant’s variation.

$$W_1 = \frac{0.09572s^2 + 209s + 9.924 \times 10^4}{s^2 + 2709s + 1.557 \times 10^6} \quad (17)$$

$$W_2 = \frac{0.09856s^2 + 218.1s + 1.048 \times 10^5}{s^2 + 2736s + 1.596 \times 10^6} \quad (18)$$

$$W_3 = \frac{9.426 \times 10^{-6} s^2 + 117.2s + 8.427 \times 10^4}{s^2 + 635.9s + 1.081 \times 10^5} \quad (19)$$

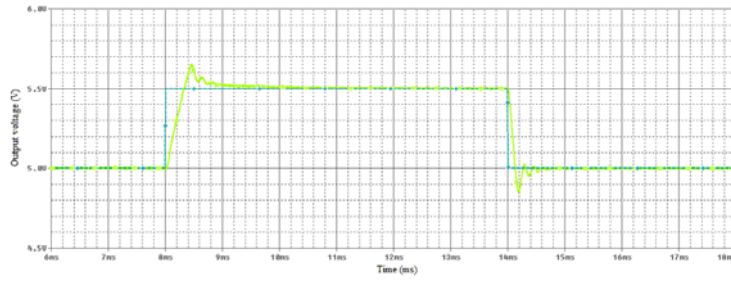

**Fig. 4** Output voltage waveform for step change in the reference

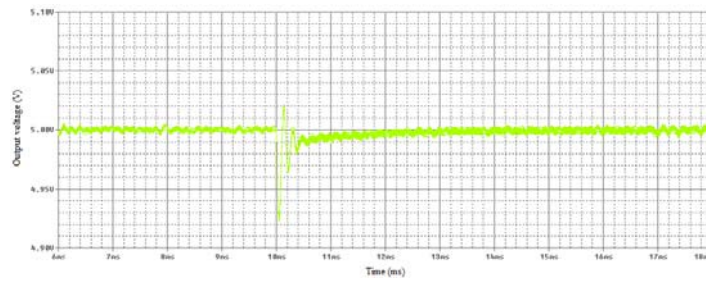

**Fig. 5** Output voltage waveform for load step change (from  $60 \Omega$  to  $31 \Omega$ )

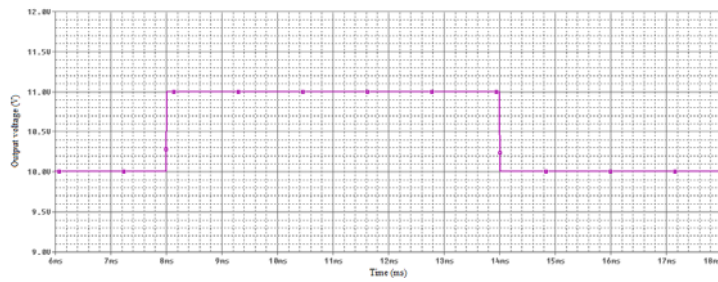

(a)

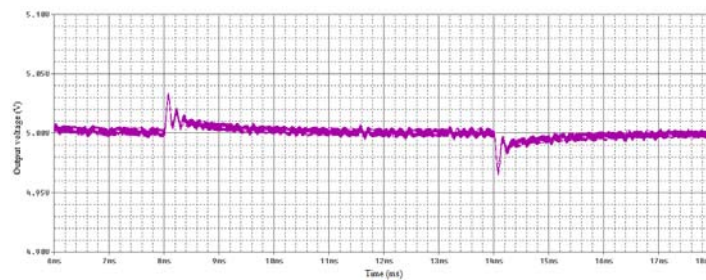

(b)

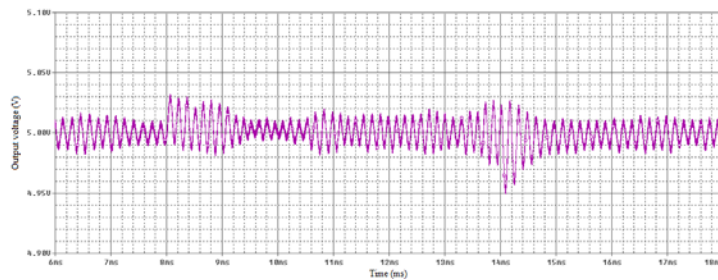

(c)

**Fig. 6** Output response for step change in line voltage, (a) Input line voltage, (b) Output voltage for nominal plant, (c) Perturbed plant with  $10.8 \text{ nF}$

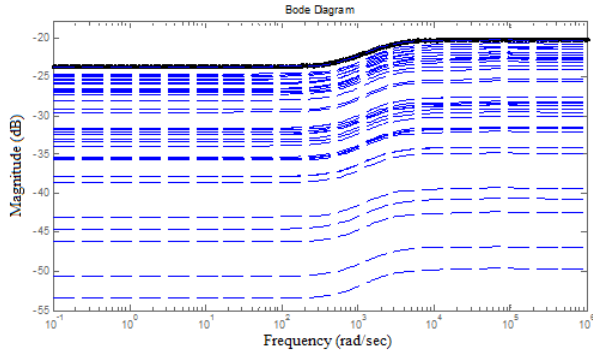

Fig. 7 Uncertainty weighting selection for  $G_{vd}$

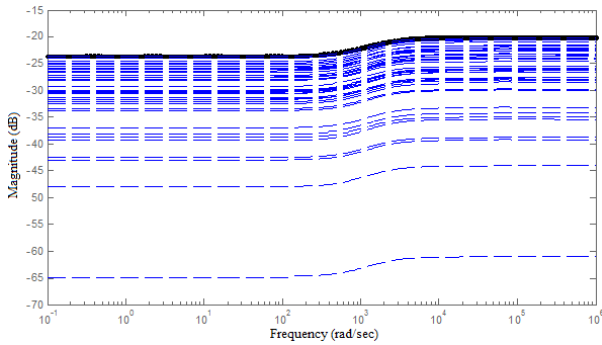

Fig. 8 Uncertainty weighting selection for  $G_{vg}$

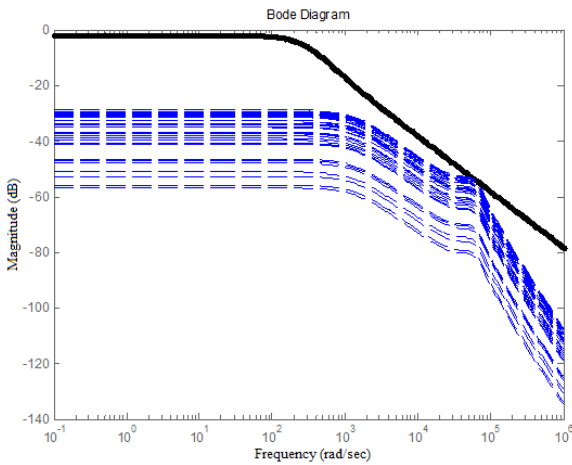

Fig. 9 Uncertainty weighting selection for  $Z_o$

The block diagram of RP controller synthesis is depicted in Fig. 10. The generalized system,  $P$  is given by

$$P = \begin{bmatrix} 0 & 0 & 0 & 0 & 0 & W_1 & 0 \\ 0 & 0 & 0 & 0 & 0 & 0 & W_2 B \\ 0 & 0 & 0 & W_3 & 0 & 0 & 0 \\ W_4 G_{vg} & W_4 G_{vd} & W_4 Z_o & W_4 Z_o & 0 & W_4 G_{vg} & W_4 G_{vd} B \\ -F_1 G_{vg} & -F_1 G_{vd} & -F_1 Z_o & -F_1 Z_o & F_1 & -F_1 G_{vg} & -F_1 G_{vd} B \\ 0 & 0 & 0 & 0 & 0 & 0 & F_2 \\ -G_{vg} & -G_{vd} & -Z_o & -Z_o & 1 & -G_{vg} & -G_{vd} B \end{bmatrix} \quad (20)$$

Uncertainty matrix has the following structure

$$\Delta = \begin{bmatrix} \Delta_{unc} & 0 \\ 0 & \Delta_{perf} \end{bmatrix} \quad (21)$$

where  $\Delta_{perf}$  is a  $2 \times 2$  full complex perturbation matrix, and  $\Delta_{unc}$  has the following block-diagonal structure

$$\Delta_{unc} = \begin{bmatrix} \Delta_1 & 0 & 0 & 0 \\ 0 & \Delta_2 & 0 & 0 \\ 0 & 0 & \Delta_3 & 0 \\ 0 & 0 & 0 & \Delta_4 \end{bmatrix} \quad (22)$$

The function “*dksyn*” in MATLAB is used to synthesize a robust controller via D-K iteration with performance weighting functions of (11), (12). After ten iterations a 12<sup>th</sup> order controller is obtained. Applying hankel-norm base approach for model reduction, a 3<sup>rd</sup> order transfer function is obtained

$$K(s) = \frac{9.572 \times 10^7 s^2 + 1.153 \times 10^{11} s + 2.041 \times 10^{13}}{s^3 + 3.646 \times 10^6 s^2 + 5.984 \times 10^8 s + 5.623 \times 10^9} \quad (23)$$

Fig. 11 shows framework for controller analysis. The closed-loop system has RP if and only if  $\sup \mu_{\Delta}(M) \leq 1$ . In addition, closed-loop system is robustly stable if and only if  $\sup \mu_{\Delta_{unc}}(M_{11}) \leq 1$ . From Figs. 12 and 13, it is apparent that closed-loop system has both robust stability and RP.

## 4.2 Simulation and Comparison

The RP controller of Eq. (17) is realized using op-amps and closed-loop system simulation results are displayed in Figs. 14 to 16. Fig. 14 shows that RP controller has primary objectives of tracking, line regulation, and load regulation for nominal plant.

Output voltage waveform for a step change in the input voltage is shown Fig. 15 for several perturbations. Input voltage waveform is again the same as Fig. 6(a). It can be seen that the performance of the system is not affected by variation of the load resistance or power circuit components tolerances.

Output voltage waveform for a load step change (from 60  $\Omega$  to 31  $\Omega$ ) is shown Fig. 16 for several perturbations. It is observed that power circuit components tolerances do not affect system performance significantly.

## 5 Conclusion

A NP  $H_{\infty}$  controller and a RP controller design for SRC were investigated in this paper. Both controllers have tracking, line regulation, and load regulation for nominal plant. RP controller is advantageous over NP controller in dealing with uncertainties. The RP controller achieves both robust stability and RP in the presence of load variation and power circuit components tolerances.

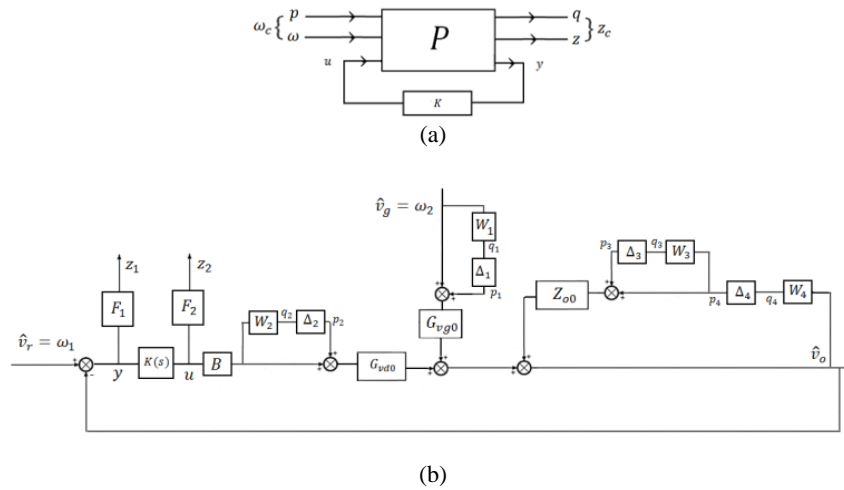

**Fig. 10** RP controller synthesis (a) Standard configuration (b) SRC control system

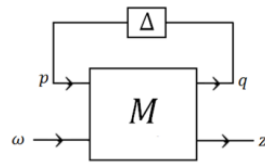

**Fig. 11** Analysis framework

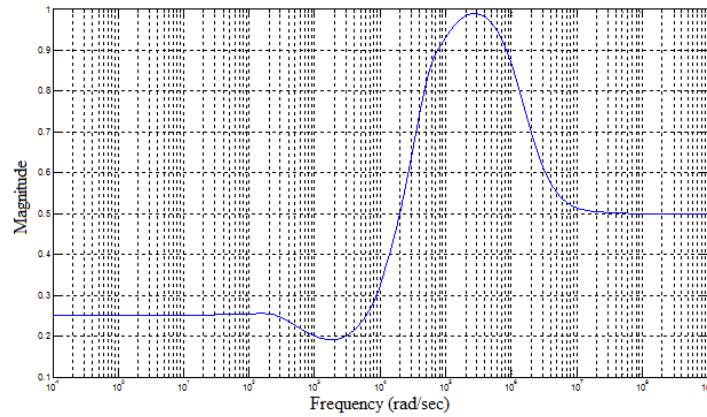

**Fig. 12**  $\mu_{\Delta}(M)$  to verify robust performance

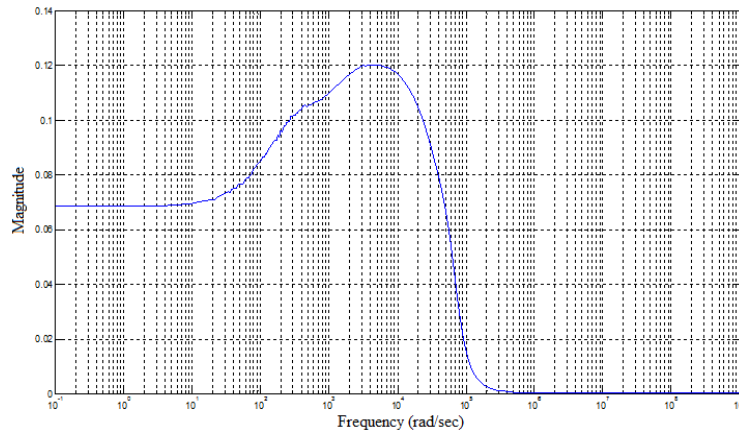

**Fig. 13** Robust stability

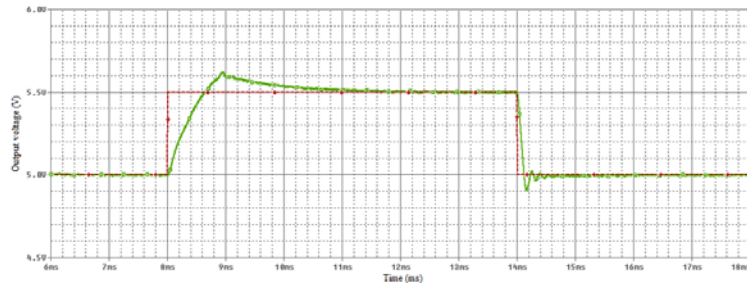

(a)

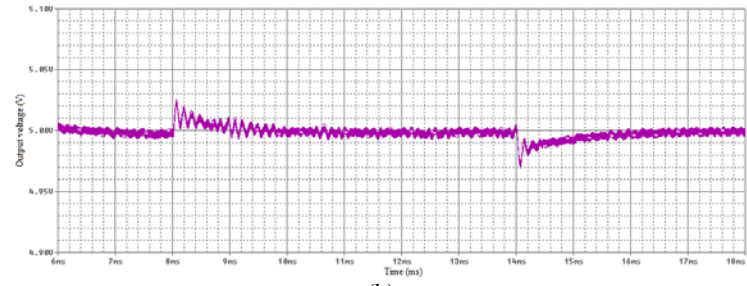

(b)

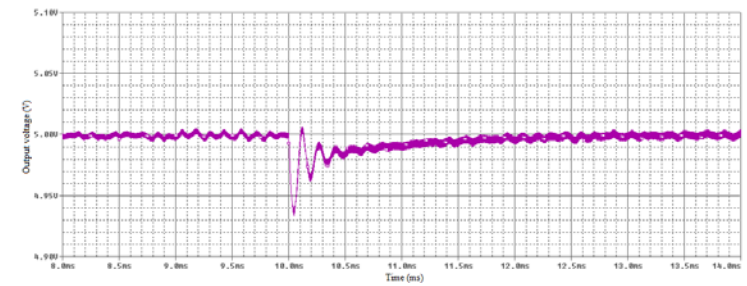

(c)

**Fig. 14** Robust controller simulation results for nominal plant (a)Tracking (b) Line regulation (c) Load regulation

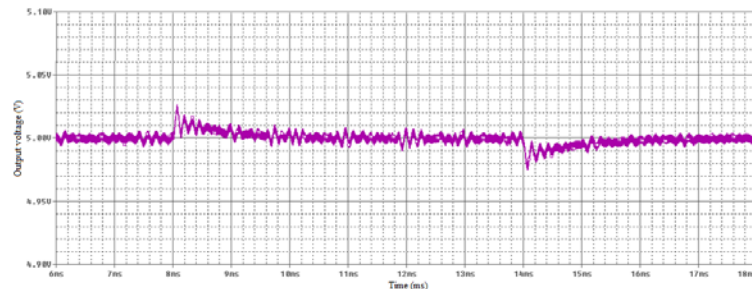

(a)

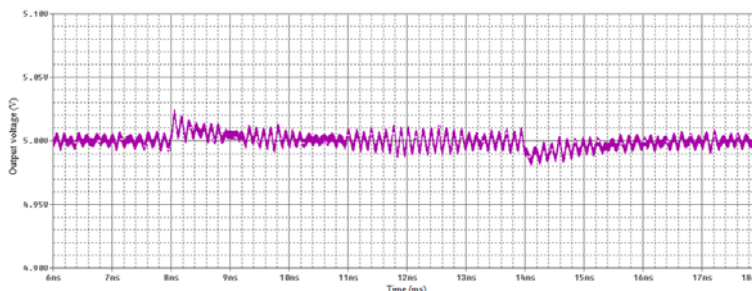

(b)

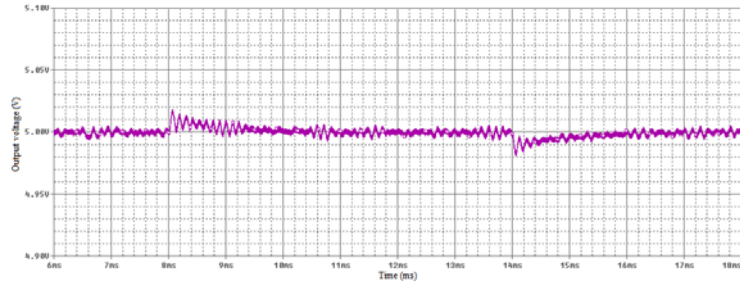

(c)

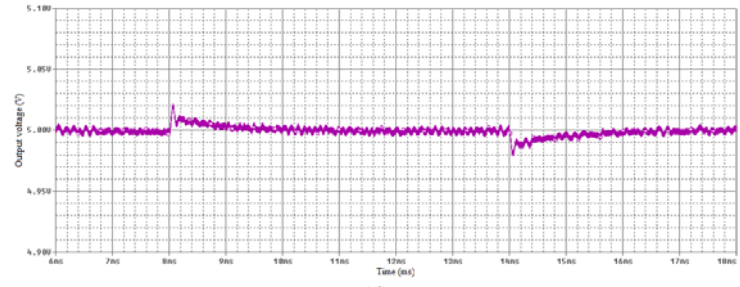

(d)

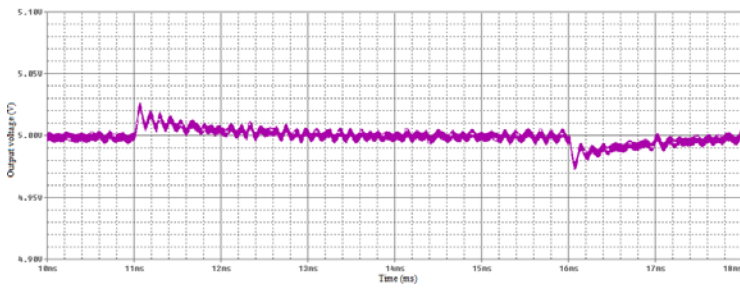

(e)

**Fig. 15** Perturbed plant Output response for step change in line voltage

(a)  $L = 300\mu H$     (b)  $C = 10.8nF$     (c)  $R = 70\Omega$

(d)  $R = 50\Omega$     (e)  $C_f = 30\mu F$

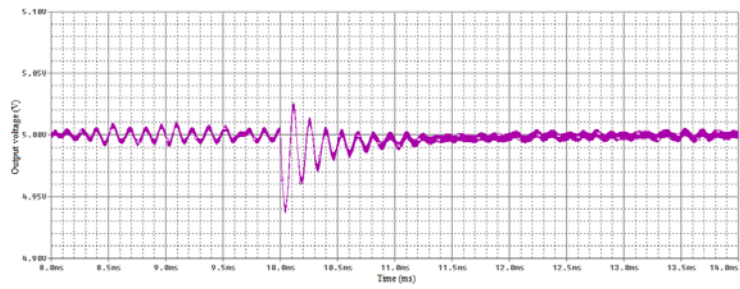

(a)

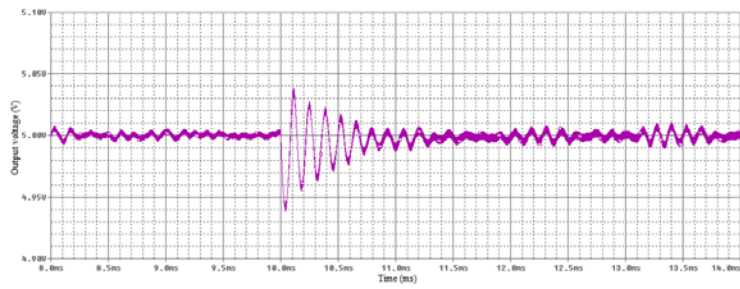

(b)



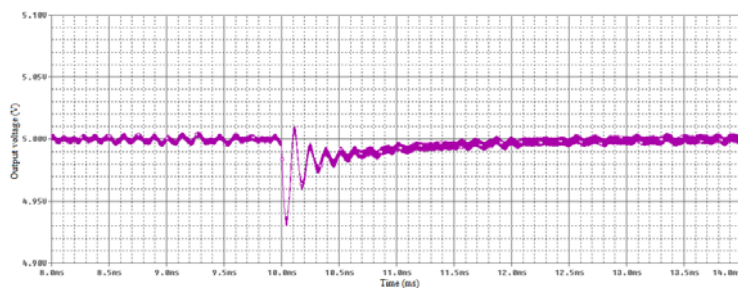

(c)

**Fig. 16** Perturbed plant Output response for load step change (a)  $L = 300\mu H$  (b)  $C = 10.8nF$  (c)  $C_f = 30\mu F$

## References

- [1] Thrimawithana D. J. and Madawala U. K., "Analysis of split-capacitor push-pull parallel-resonant converter in boost mode," *IEEE Trans. Power Electron.*, Vol. 23, No. 1, pp. 359-368, Jan. 2008.
- [2] Steigerwald R. L., "A comparison of half-bridge resonant converter topologies," *IEEE Trans. Power Electron.*, Vol. 3, No. 2, pp. 174-182, Apr. 1988.
- [3] Groot H. de, Janssen E., Pagano R. and Schetters K., "Design of a 1-MHz LLC Resonant Converter Based on a DSP-Driven SOI Half-Bridge Power MOS Module," *IEEE Trans. Power Electron.*, Vol. 22, No. 6, pp. 2307-2320, Nov. 2007.
- [4] Wang Z. Q., Sznaier M., Batarseh I. and Bu J., "Robust controller design for a series resonant converter" *IEEE Trans. Power Electron.*, Vol. 32, No. 1, pp. 221-233, Jan. 1996.
- [5] Bu J., Sznaier M., Wang Z. and Batarseh I., "Robust controller design for a parallel resonant converter using  $\mu$ -synthesis," *IEEE Trans. Power Electron.*, vol. 12, No. 5, pp. 837-853, Sep. 1997.
- [6] Lin J. -L. and Lew J. S., "Robust controller design for a series resonant converter via duty-cycle control," *IEEE Trans. Power Electron.*, Vol. 14, No. 5, pp. 793-802, Sep. 1999.
- [7] Ye Z. M., Lam J. C. W., Jain P. K. and Sen P. C., "A Robust One-Cycle Controlled Full-Bridge Series-Parallel Resonant Inverter for a High-Frequency AC (HFAC) Distribution System," *IEEE Trans. Power Electron.*, Vol. 22, No. 6, pp. 2331-2343, Nov. 2007.
- [8] Sun J. and Grotstollen H., "Averaged modeling and analysis of resonant converter," *IEEE PESC Rec.*, pp. 707-713, 1993.
- [9] Wallis G. F. and Tymerski R., "A Generalized approach for synthesis of robust switching regulators," *IEEE PESC Rec.*, pp. 322-328, 1998.



**Ali Mohammadpour** received the B.Sc. degree from the University of Tabriz, Tabriz, Iran, and the M.Sc. degree from the Sharif University of Technology, Tehran, Iran, in 2007 and 2009, respectively, both in electrical engineering. His research interests include design, modeling, and control of power electronics converters, EMC, and power quality issues. He is currently technical director of accredited EMC laboratory at Mizan Gostar Rayaneh, Tehran, Iran.



**Hossein Mokhtari** was born in Tehran, Iran on Aug.19, 1966. He obtained his B.Sc. degree in Electrical Engineering in 1989 from Tehran University in Tehran, Iran. He joined Electric Power Research Center Institute in 1989 and worked for three years in the consulting division of power dispatching projects. In 1992 he was granted a scholarship from Iran Ministry of Culture and Higher Education for his M.Sc. degree. He finished his masters program in the field of power electronics in University of New Brunswick, Canada in 1994. In 1994, he entered Toronto University in Toronto, Canada. In 1999, he finished his Ph.D. degree. Since 2000, he has been with the School of Electrical Engineering at Sharif University in Tehran, Iran in 2000. He is currently an associate professor in this department. His research interests include power quality, power electronics and application of power electronics in power distribution systems. He is also a senior consultant to several utilities and industries.



**Mohammad Reza Zolghadri** received the B.S. and M.S. degrees from the Sharif University of Technology, Tehran, Iran, in 1989 and 1992, respectively, and the Ph.D. degree from the Institute National Polytechnique de Grenoble, Grenoble, France, in 1997, all in electrical engineering. Since 1997, he has been with the department of Electrical Engineering, Sharif University of Technology. From 2000 to 2003, he was a Senior Researcher in the Electronics Laboratory of SAM Electronics Company, Tehran. From 2003 to 2005, he was a Visiting Professor in the North Carolina A&T State University, Greensboro. He is the author of more than 50 publications in power electronics and variable speed drives. His fields of interest are application of power electronics in renewable energy systems and hybrid electric vehicle, variable speed drives, and modeling and control of power electronic converters.