

# Investigation and Control of Unstable Chaotic Behavior Using of Chaos Theory in Electrical Power Systems

H. R. Abbasi\*, A. Gholami\*, M. Rostami\*\* and A. Abbasi\*\*

**Abstract:** This paper consists of two sections: control and stabilizing method for chaotic behaviour of converter is introduced in first section of this paper for the removal of harmonics caused by the chaotic behaviour in current converter. For this work, a Time-Delayed Feedback Controller (TDFC) control method for stability chaotic behaviour of buck converter for switching courses in current control mode is presented. This behaviour is demonstrated by presenting a piecewise linear discrete map for this converter and then combining the feedback equation to obtain the overall equation of the converter. A simple time-delay feedback control method is applied to stabilize the Unstable Periodic Orbits (UPOs). In second section the effect of a parallel Metal Oxide Arrester (MOV) on the ferroresonance oscillations of the transformer is studied. It is expected that the arresters generally cause ferroresonance drop out. Simulation has been done on a three phase power transformer with one open phase. Effect of varying input voltage has been studied. The simulation results reveal that connecting the arrester to the transformer poles, exhibits a great mitigating effect on ferroresonant over voltages. Phase plane along with bifurcation diagrams are also presented. Significant effect on the onset of chaos, the range of parameter values that may lead to chaos and magnitude of ferroresonant voltages has been obtained, shown and tabulated.

**Keywords:** TDFC Method, Buck Converter, Fuzzy Diagram, Bifurcation Diagram, Power Transformer, Chaotic Ferroresonance.

## 1 Introduction

Two important elements in power electrical systems are converters and transformers. It is because analyzing and investigation of these two elements behavior has remarkable importance. Processing the electrical potential by means of power electronic instruments is the function of power electronic systems. The main part of these systems is the power converters that transforms the electrical energy from one form to other forms. Some of these converters are AC/DC, AC/AC, DC/DC, and DC/AC [1] - [3].

The advantages of these converters are their small size, low weight, and high efficiency. In spite of all these advantages, the main problem with them is their nonlinear and varying function with time, which brings

complexity to their design and dynamic behaviour analysis. Their nonlinearity and variation with time is the result of the circuit topology changes because of the status changes of the switches in the performance period of the switching converters.

Sampling of the continuous behaviour of these converters leads to the discrete behaviour model in their switching intervals. Sometimes the behavioural analysis of the converters in the switching intervals has great complexity such that the order of the current or voltage in decreasing or increasing rate in the switching intervals seems to be lost. This strange behaviour in these intervals is called the chaotic converter behaviour. So far, many studies have been carried out to evaluate the chaotic behaviour of the switching converters [4] - [10]. Studies on voltage control mode are carried out in discrete spaces. Study of the chaotic behaviour of the multilayer converters is possible with higher degree discrete equations [11]. However, studying the chaotic behaviour of fixed points of the converter equations such that the behaviour can be followed has not been precisely done in any of the former studies. This paper presents a discrete model of buck converter behaviour in current control mode. By presenting an equation for

---

Iranian Journal of Electrical & Electronic Engineering, 2011.

Paper first received 5 Dec. 2010 and in revised form 9 Feb. 2011.

\* The Authors are with the Center of Excellence for Power System Automation and Operation, Department of Electrical Engineering Iran University of Science and Technology, Narmak, Tehran 16844, Iran.

E-mails: [hamid2005444@yahoo.com](mailto:hamid2005444@yahoo.com), [gholami@iust.ac.ir](mailto:gholami@iust.ac.ir).

\*\* The Authors are with the Department of Electrical Engineering, Shahed University, Persian Gulf Free Way, Tehran, Iran.

E-mails: [rostami@shahed.ac.ir](mailto:rostami@shahed.ac.ir), [ataollah.abbasi@gmail.com](mailto:ataollah.abbasi@gmail.com).

the duty cycle and the time when the switch is on, we obtain a final, analyzable equation which is nonlinear and discrete, for the study of the chaotic condition of the converter. Finally, an analysis of the equation in the chaotic field and also the converter behaviour around the equilibrium point is presented. Evaluation of the chaotic behaviour in discrete spaces [12], [13], was performed in the voltage control mode. However, the circuit behaviour of these converters in current control modes were studied by considering various circuits for the feedback loops [14]. We also intend to study buck converter behaviour in current control mode by a saturable function in discrete space, obtained by the subtraction of the circuit current and the reference current. Stabilizing Unstable Periodic Orbits (UPOs) is an important topic in chaos control research. The first control, known as the Ott-Grebogi-Yorke (OGY) method proposed by Ott et al. [15], stabilizes UPOs using small discontinuous parameter perturbation. Some further extensions of this method have lately been proposed [16]- [19], and they are quite popular in the fields of nonlinear dynamics today. As an alternative to the OGY method to control chaos, a linear Time Delayed Feedback Control (TDFC) method has been proposed to stabilize the UPOs in chaotic systems [20]-[22]. This method involves a control signal formed on the basis of the difference between the current state of the system and the state, delayed by one period of the UPO. The advantage of this method is that it does not require the exact information of the UPO. All it needs is a time-delay constant which is the period of the target UPO. This method is very simple and has been successfully applied to various systems [21], [22]. Power-electronics systems are rich in bifurcation and nonlinear phenomena [23], [24], [25]. Control of chaos in these systems has become one of the popular research topics in power electronics as well as circuits and systems communities [26], [27]. Recently, the TDFC method has been applied successfully to stabilize the UPOs in chaotic switching dc/dc converters [18]. As many other practical power-electronics circuits also exhibit bifurcation behaviour and chaos, there is a strong motivation to study the control of the chaos in these systems. In this brief, we attempt to apply the TDFC method to stabilize the UPO in a Pulse Width Modulation (PWM) current- mode buck converter.

Ferroresonance is a complex nonlinear electrical phenomenon that can cause dielectric & thermal problems to components power system. Electrical systems exhibiting ferroresonant behaviour are categorized as nonlinear dynamical systems. Therefore conventional linear solutions cannot be applied to study ferroresonance. The prediction of ferroresonance is achieved by detailed modeling using a digital computer transient analysis program [28]. Ferroresonance should not be confused with linear resonance that occurs when inductive and capacitive reactance of circuit is equal. In linear resonance the current and voltage are linearly

related and are frequency dependent. In the case of ferroresonance it is characterized by a sudden jump of voltage or current from one stable operating state to another one. The relationship between voltage and current is dependent not only on frequency but also on other factors such as system voltage magnitude, initial magnetic flux condition of transformer iron core, total loss in the ferroresonant circuit and moment of switching [29].

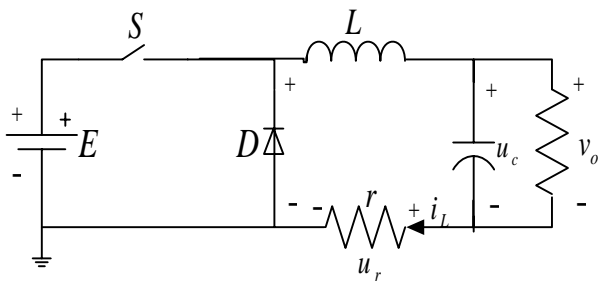
Ferroresonance may be initiated by contingency switching operation, routine switching, or load shedding involving a high voltage transmission line. It can result in Unpredictable over voltages and high currents. The prerequisite for ferroresonance is a circuit containing iron core inductance and a capacitance. Such a circuit is characterized by simultaneous existence of several steady-state solutions for a given set of circuit parameters. The abrupt transition or jump from one steady state to another is triggered by a disturbance, switching action or a gradual change in values of a parameter. Typical cases of ferroresonance are reported in [28], [29], [30] and [31]. Theory of nonlinear dynamics has been found to provide deeper insight into the phenomenon. [32], [33], [34] and [35] are among the early investigations in applying theory of bifurcation and chaos to ferroresonance. The susceptibility of a ferroresonant circuit to a quasi-periodic and frequency locked oscillations are presented in [36], [37]. The effect of initial conditions is also investigated. [38] is a milestone contribution highlighting the effect of transformer modeling on the predicted ferroresonance oscillations. Using a linear model, authors of [39] have indicated the effect of core loss in damping ferroresonance oscillations. The importance of treating core loss as a nonlinear function of voltage is highlighted in [34]. An algorithm for calculating core loss from no-load characteristics is given in [40]. Evaluation of chaos in voltage transformer, effect of resistance of key on the chaotic behavior voltage transformer and subharmonics that produced with ferroresonance in this type transformer and quantification of the chaotic behavior of ferroresonant voltage transformer circuits are studied in [36], [41] and [42].

## 2 First Section: Buck Converter

### 2.1 Studying of Buck Converter Behaviour in Current Control Mode

For studying the buck converter chaotic behaviour in current control mode, the converter circuit in Fig. 1 is analyzed. It is presumed that the converter performance is in the continuous mode.

In the following circuit, we consider the inducer current equations in continuous mode in a switching period. The first interval refers to the time when the switch is on. The time  $t_1 = nT$  to  $nT + DT$  refers to the time when inducer current increases. The second interval is the time when the switch is off and the



**Fig. 1** Buck converter circuit.

inductor current decreases and is shown by  $t_2 = nT + DT$  to  $(n+1)T$ . The overall solution of inductance current in a switching period is Eq. (1).

$$i_{n+1} = \left( \left( i_n - \frac{E}{R} \right) + \frac{E}{R} \right) e^{-\frac{RT(1-D)}{L}} \quad (1)$$

## 2.2 The Current Feedback Equation Function

To solve Eq. (1), it is required to define variable  $D$  in terms of currents. To this work, the duty cycle amount ( $D$ ) is obtained from the feedback equation. Regarding this, the control algorithm causes an  $\varepsilon_n$  difference between the reference  $I$  and the sampled load current. This controller also includes a rectification coefficient  $K$  that increases the error by the factor of  $K$  and produces the control voltage  $u_n$ .

Block diagram of current controller is shown in Fig. 2. Its equation is:

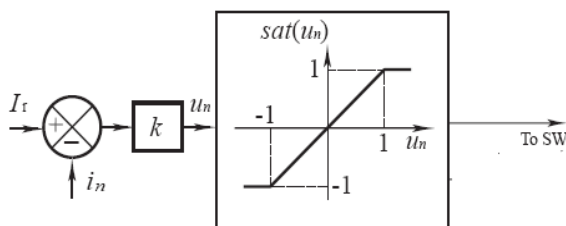
$$u_n = K(I - i_n) \quad (2)$$

Duty cycle ( $D$ ) is defined in terms of difference voltage as follow:

$$D_n = 0.5 + \text{sat}(u_n) / 2 \quad (3)$$

Combining this equation and the map current equation, the overall current Eq. (4) is obtained.

$$i_{n+1} = \left( \left( i_n - \frac{E}{R} \right) e^{-\frac{RT \left( 0.5 + \frac{\text{sat}(K(I - i_n))}{2} \right)}{L}} + \frac{E}{R} \right) \times \dots \times e^{-\frac{RT \left( 1 - \left( 0.5 + \frac{\text{sat}(K(I - i_n))}{2} \right) \right)}{L}} \quad (4)$$



**Fig. 2** Block diagram of current controller.

Concerning the feedback function behaviour; this map is defined as a three part function that consists of two saturated regions and a linear region of saturated function.

$$i_{n+1} = \begin{cases} \left( \left( i_n - \frac{E}{R} \right) e^{-\frac{RT}{L}} + \frac{E}{R} \right) & \text{for } i_n < I - \frac{1}{K} \\ \left( i_n - \frac{E}{R} \right) e^{-\frac{RT \left( 0.5 + \frac{\text{sat}(K(I - i_n))}{2} \right)}{L}} & \times \dots \\ \left( i_n - \frac{E}{R} \right) e^{-\frac{RT \left( 1 - \left( 0.5 + \frac{\text{sat}(K(I - i_n))}{2} \right) \right)}{L}} & \text{for } I + \frac{1}{K} < i_n < I - \frac{1}{K} \\ \left( \left( i_n - \frac{E}{R} \right) e^{-\frac{RT}{L}} + \frac{E}{R} \right) e^{-\frac{RT_2}{L}} & \text{for } i_n > I + \frac{1}{K} \end{cases} \quad (5)$$

## 2.3 Base Simulation

Setting the parameters of Table 1 in the discrete dynamic equations of the converter, different output signal behaviour is obtained for different values. Fig. 3 and Fig. 4 show the time discrete signals for the converter function periods at different feedback gains.

**Table 1** Buck converter parameters.

Parameter	Value
E(v)	20
L(H)	.0116
R( $\Omega$ )	10
T(s)	.0005

By selecting the basic condition for the converter current that performs in the continuous mode, time behaviour of the signal is obtained.

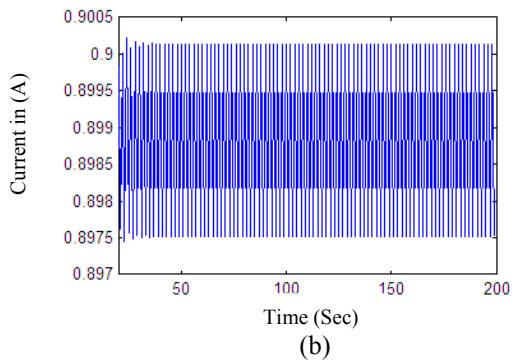
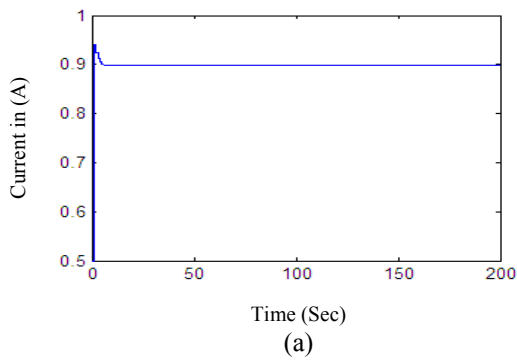
It is observed that although the input improves as the negative feedback increases, the converter leaves single frequency and moves toward chaos.

Figure 5 demonstrates the state in which the system undergoes a strange attractor set and chaos.

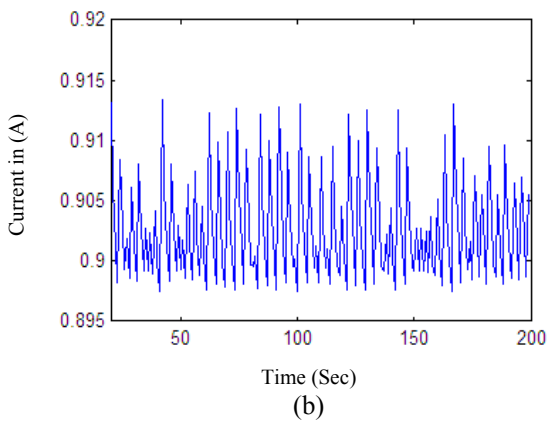
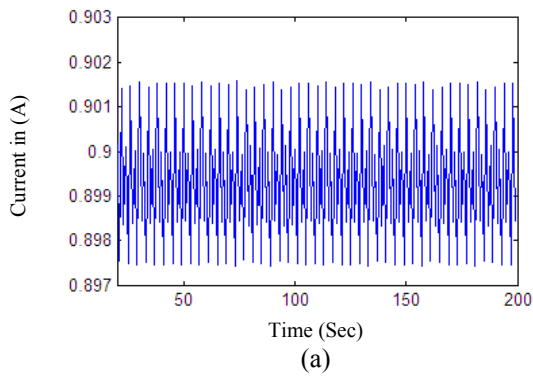
Concerning the time and fuzzy signal behaviour of the current, it seems that the system underwent chaos based on local bifurcation logic. The converter bifurcation diagram is shown in terms of gain feedback of current control in Fig. 6. It is obvious that the converter undergoes chaos for gains higher than eight.

## 2.4 TDFC Method

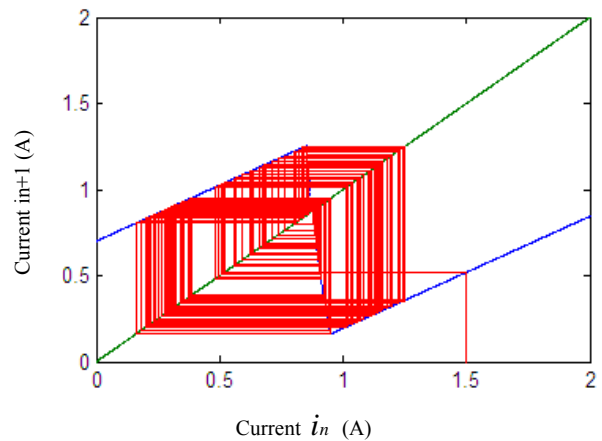
We apply the TDFC method to the system that has been shown in Fig. 7. A term  $\eta(i(t) - i(t - \tau))$  is added to the original control signal, where  $\tau$  is the period of the target UPO and  $\eta$  is an adjustable parameter related to the coupling strength.



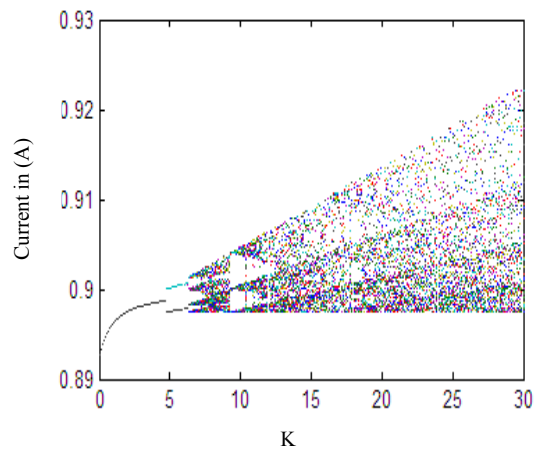
**Fig. 3** (a) Period-1 (b) Priod-4.



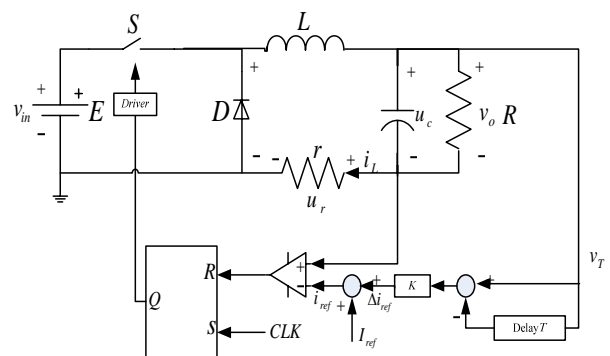
**Fig. 4** (a) Period-8 (b) Chaotic behavior.



**Fig. 5** Phase plane diagram for  $K=2$  &  $I_{ref}=0.9$ .



**Fig. 6** Bifurcation diagram for  $I_{ref}=0.9$  &  $K$  is variable.



**Fig. 7** Circuit of Buck Converter with Time Delay Feedback Controller.

We can easily observe that when  $i(t) = i(t - \tau)$ , the extra term vanishes and  $i(t)$  travels on the target UPO. It is well known that in a chaotic system, there are many UPOs with different periods. Since system is

nonautonomous with a switching period  $T$ , naturally an UPO with period  $T$ , i.e.  $\tau = T$  as the target UPO in simulation is selected. This target UPO is not unique because power-electronics circuits can have multiple attractors [25], e.g., a  $T$ -periodic orbit and a higher periodic orbit can coexist in a same set of circuit parameters.

Control function is added to the feedback control of the buck current. The new equations may be represented as the followings.

$$f(i_n) = \eta(i_n - i_{n-1}) \quad (6)$$

$$d_n = 0.5 + 0.5 \text{sat}\left(K(I_{\text{ref}} - i_n) + \eta(i_n - i_{n-1})\right) \quad (7)$$

With a suitable selection of  $\eta$  in mT periodic state or chaos can be stabilized into a  $T$  periodic state. One of the restrictions of the TDFC method is that the target orbit can only have a period that is an integer factor of  $T$  (i.e.  $nT$ , where  $n$  is an integer). Also, it is not possible for the controlled system to converge to an orbit of period  $T/2$  (or  $T/m$ , where  $m$  is an integer).

The circuit equation with stabilizer is:

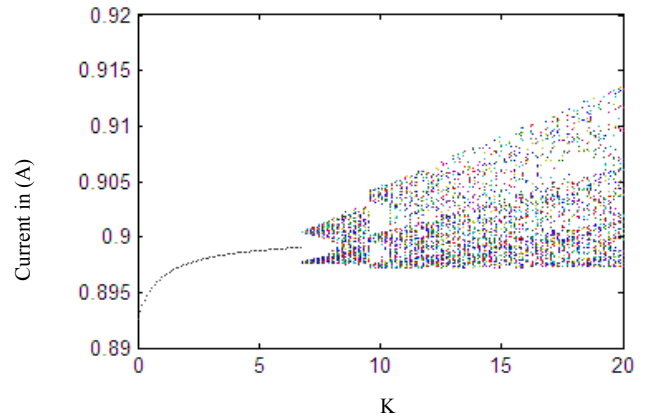
$$i_{n+1} = \begin{cases} \left( \left( i_n - \frac{E}{R} \right) e^{-\frac{RT}{L}} + \frac{E}{R} \right) & \text{for } i_n < I - \frac{1}{K} \\ \left( \left( i_n - \frac{E}{R} \right) e^{-\frac{RT}{L} \left( 0.5 + \frac{\text{sat}\left(K(I_{\text{ref}} - i_n) + \eta(i_n - i_{n-1}))\right)}{2} \right)} \right) & \times \dots \\ \left( \left( i_n - \frac{E}{R} \right) e^{-\frac{RT}{L} \left( 1 - \frac{\text{sat}\left(K(I_{\text{ref}} - i_n) + \eta(i_n - i_{n-1}))\right)}{2} \right)} \right) & \\ \times e & \\ & \text{for } I + \frac{1}{K} < i_n < I - \frac{1}{K} \\ \left( \left( i_n - \frac{E}{R} \right) e^{-\frac{RT}{L}} + \frac{E}{R} \right) e^{-\frac{RT_s}{L}} & \text{for } i_n > I + \frac{1}{K} \end{cases} \quad (8)$$

Bifurcation of the chaotic behaviour of the circuit for different values of  $\eta$  can be observed in Fig. 8 and Fig. 9 and Fig. 10. As  $\eta$  increases, up to the determined value of 2.7 the chaotic behaviour will be suppressed. As it can be seen in Fig. 11, the chaotic behaviour grows dramatically at 3.7.

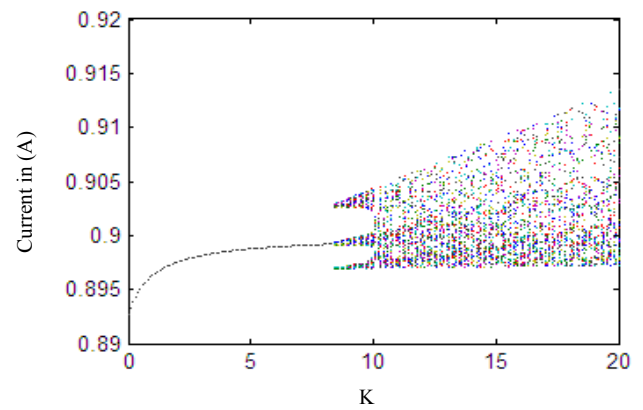
### 3 Second Section: Power Transformer

#### 3.1 System Modeling

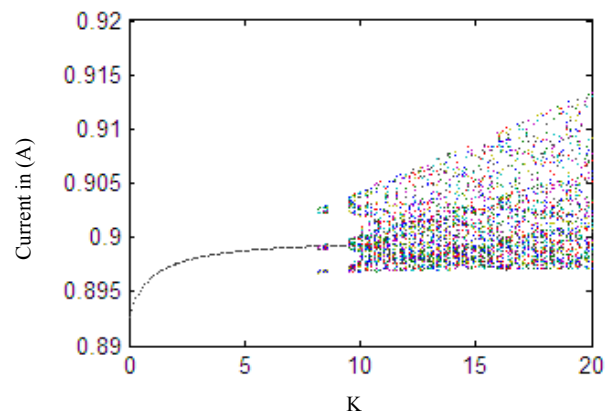
Transformer is assumed to be connected to the Power System while one of the three switches are open and only two phases of it are energized, which produce induced voltage in the open phase. This voltage, back feeds the distribution line. Ferroresonance will occur if the distribution line has high capacitive. System involves the nonlinear magnetizing reactance of the transformer's open phase and resulted shunt and series capacitance of the distribution line.



**Fig. 8** Bifurcation diagram for  $I_{\text{ref}} = 0.9$  &  $\eta = 1$  &  $K$  is variable.

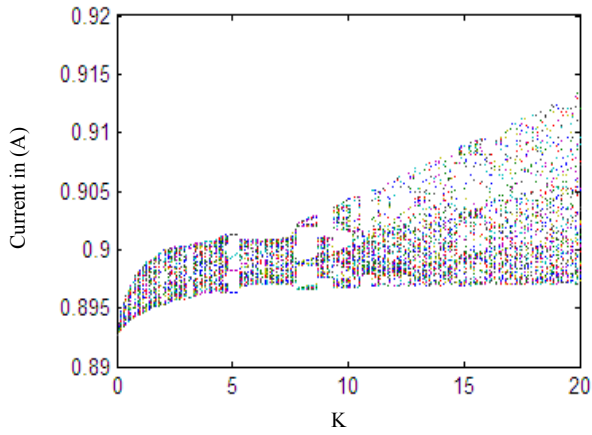


**Fig. 9** Bifurcation diagram for  $I_{\text{ref}} = 0.9$  &  $\eta = 1.5$  &  $K$  is variable.



**Fig. 10** Bifurcation diagram for  $I_{\text{ref}} = 0.9$  &  $\eta = 2.7$  &  $K$  is variable.

Base system model is adopted from [34] with the MOV arrester connected across the transformer winding which that is shown in Fig. 12 Linear approximation of the peak current of the magnetization reactance can be



**Fig. 11** Bifurcation diagram for  $I_{ref} = 0.9$  &  $\eta = 3.6$  &  $K$  is variable.

presented by Eq. (9):

$$i_1 = a\lambda \quad (9)$$

However, for very high currents, the iron core might be saturated where the flux-current characteristic becomes highly nonlinear. The  $\lambda - i_1$  characteristic of the transformer can be demonstrated in Eq. (10):

$$i_1 = a\lambda + b\lambda^q \quad (10)$$

Arrester can be expressed by the Eq. (11):

$$V = KI^\alpha \quad (11)$$

where  $V$  is resistive voltage drop,  $I$  represents arrester current and  $K$  is constant and  $\alpha$  is nonlinearity constant. The differential equation for the circuit in Fig. 1 can be derived as following:

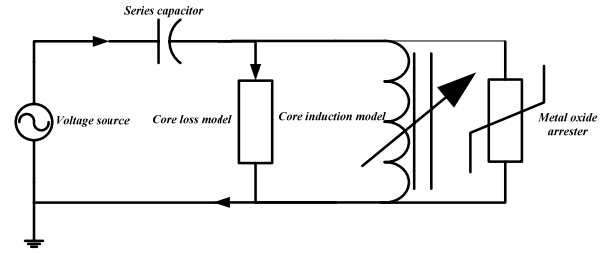
$$\begin{aligned} \omega E \cos \omega t &= p^2 \lambda + \frac{p\lambda}{RC} + \left(\frac{1}{C}\right)(a\lambda + b\lambda^q) \\ &+ \left(\frac{1}{C}\right)\left(\frac{|p\lambda|}{K}\right)^\alpha \text{sign}(p\lambda) \end{aligned} \quad (12)$$

where  $p = \frac{d}{dt}$  represents the power frequency and  $E$  is the peak value of the voltage source, shown in Fig. 12.

Presenting in the form of state space equations,  $\lambda$  and  $p\lambda$  will be state variables as following:

$$\lambda = x_1, p\lambda = x_2 \quad (13)$$

$$\begin{aligned} px_2 &= \omega E \cos \omega t - \frac{x_2}{RC} - \left(\frac{1}{C}\right)(ax_1 + bx_1^q) \\ &- \left(\frac{1}{C}\right)\left(\frac{|x_2|}{K}\right)^\alpha \text{sign}(x_2) \end{aligned} \quad (14)$$



**Fig. 12** Circuit of system.

### 3.2 Simulation Results

Typical values for various system parameters considered for simulation are as following [32]:

$$q = 5 \rightarrow \begin{cases} b = 0.0005 \\ a = 0 \end{cases}$$

$$q = 7 \rightarrow \begin{cases} b = 0.001 \\ a = 0 \end{cases}$$

$$q = 11 \rightarrow \begin{cases} b = 0.0072; \\ a = 0.0028 \end{cases}$$

$$\omega = 1 \text{ p.u.}, R = 100 \text{ p.u.}, C = 0.047 \text{ p.u.}$$

$$E = 0 - 6 \text{ p.u.}, K = 2.501, \alpha = 25.$$

Initial conditions:

$$\lambda(0) = 0, p\lambda(0) = 1.44 \text{ p.u.}$$

Table 2 shows different values of  $E$ , are considered for analyzing the circuit in absence of surge arrester.

Table 3 includes the set of cases which are considered for analyzing the circuit including arrester:

Time domain simulations were performed using the MATLAB programs which are similar to EMTP simulation [30]. In cases including arrester, it can be seen that ferroresonant drop out will be occurred.

Figure 13 shows the phase plane plot of system states without arrester for  $E=1$  p.u.

Figure 14 shows the phase plane plot and time domain simulation of system states without arrester for  $E=4$  p.u. which depicts chaotic behavior and Fig. 15 shows the corresponding time domain waveform.

**Table 2** (a) behavior of system without MOV for  $E= 1, 2, 3$  (b) behaviour of system without MOV for  $E= 4, 5, 6$ .

(a)			
E \ q	1	2	3
5	Priodic	Priodic	Priodic
7	Priodic	Priodic	Chaotic
11	Priodic	Priodic	Chaotic

(b)			
E \ q	4	5	6
5	Chaotic	Chaotic	Chaotic
7	Chaotic	Chaotic	Chaotic
11	Chaotic	Chaotic	Chaotic



**Table 3** (a) behaviour of system with MOV for E= 1, 2, 3  
(b) behaviour of system with MOV for E= 4, 5, 6.

(a)

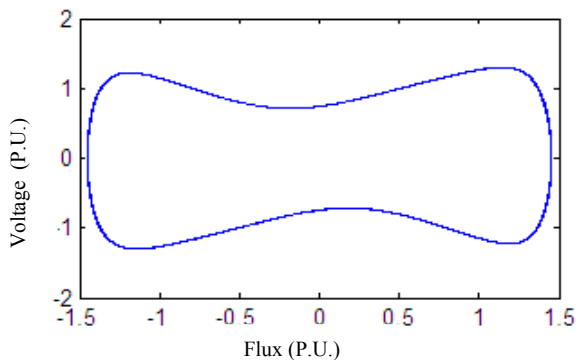
	E	1	2	3
q				
	5	Prionic	Prionic	Prionic
	7	Prionic	Prionic	Prionic
	11	Prionic	Chaotic	Prionic

(b)

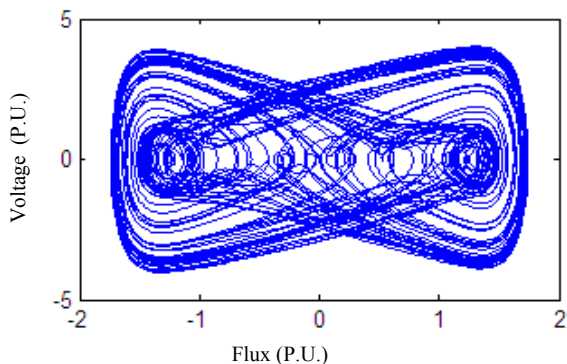
	E	4	5	6
q				
	5	Prionic	Prionic	Prionic
	7	Prionic	Prionic	Chaotic
	11	Chaotic	Chaotic	Chaotic

Also figures 16-18 show the bifurcation diagram of chaotic behaviours for three of values of q. The system shows a greater tendency for chaos for saturation characteristics with lower knee points, which corresponds to higher values of exponent q.

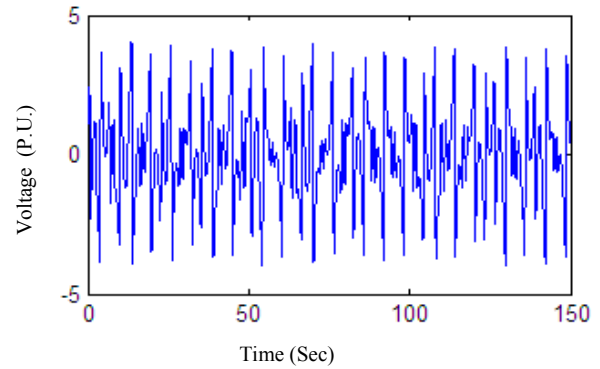
Figures 19 - 21 show that chaotic region mitigates by applying MOV surge arrester. Tendency to chaos exhibited by the system increases when q increases.



**Fig. 13** Phase plane diagram for E=1, q=11 without MOV.

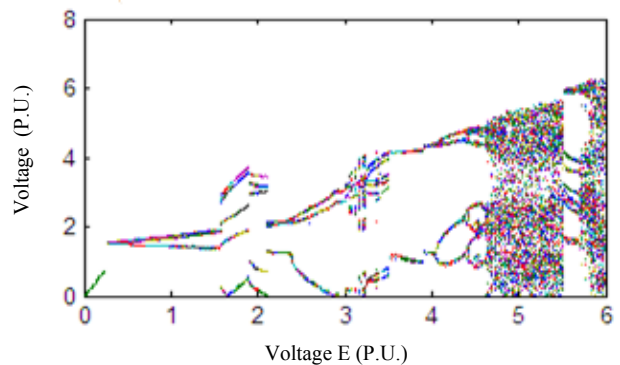


**Fig. 14** Phase plane diagram for E=4, q=11 without MOV.

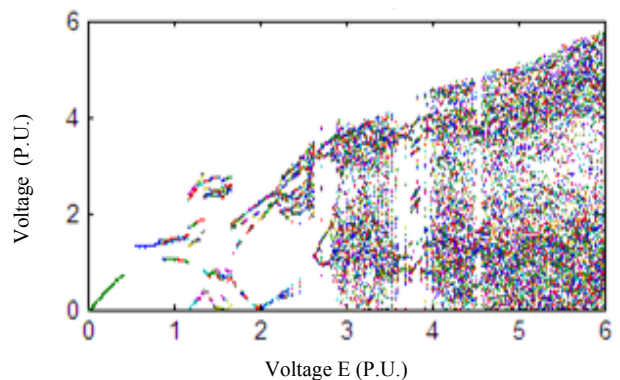


**Fig. 15** time domain chaotic wave form for E=4, q=11 without MOV.

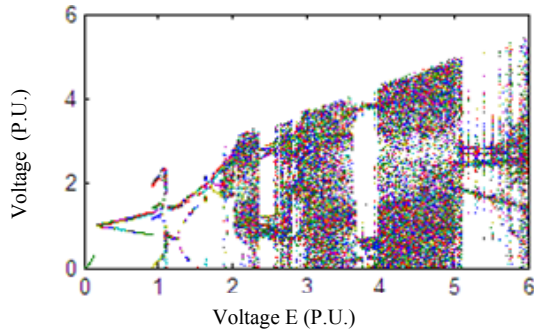
It can be observed in Figs. 19, 20 and 21 MOV makes a mitigation in ferroresonance chaotic behavior in transformer that in down value of q the chaotic region are removed and the behavior will be periodic, for greater values of q for example for q=11 independent chaotic regions which can be created under MOV nominal voltage have decreased and chaotic behavior is eliminated.



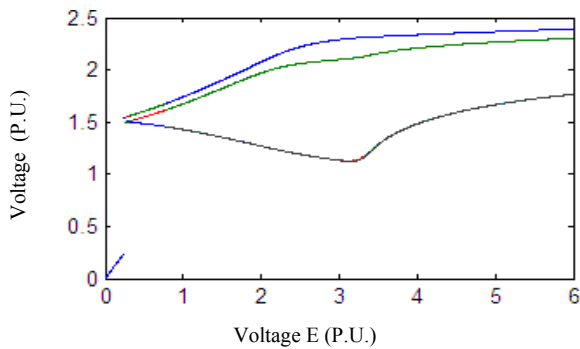
**Fig. 16** Bifurcation diagram for q=without MOV.



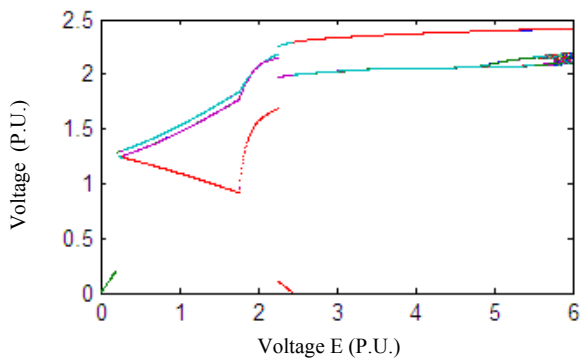
**Fig. 17** Bifurcation diagram for q=7 without MOV.



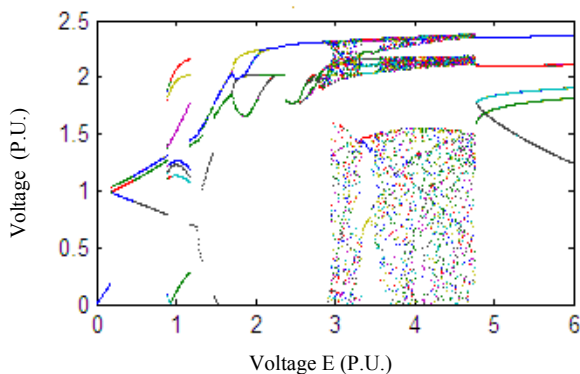
**Fig. 18** Bifurcation diagram for  $q=11$  without MOV.



**Fig. 19** Bifurcation diagram for  $q=5$  with MOV.



**Fig. 20** Bifurcation diagram for  $q=7$  with MOV.



**Fig. 21** Bifurcation diagram for  $q=7$  with MOV.

## 6 Conclusion

In case of buck converter, the TDFC method is an effective method to stabilize UPOs in this converter chaotic behaviour. This method is proposed for stabilizing UPOs in the PWM current-mode buck converter operating in higher-periodic state and chaos. Using the discrete-time map, we have shown that the original unstable equilibrium point becomes a stable equilibrium point after the TDFC method is applied. The stable operation range of the buck converter is widened. The TDFC method can be used to control the UPOs in other power-electronics circuits when they exhibit bifurcation behaviour and chaos.

In case of unloaded power transformer, the presence of the arrester results clamping the Ferroresonant over voltages in studied system. The arrester successfully suppresses and eliminates the chaotic behaviour of proposed model. Consequently, the system shows less sensitivity to initial conditions in the presence of the arrester.

## References

- [1] Rashid M. H., *Power electronics: Circuit, devices and application*, pearson/prentice hall, 2003.
- [2] Hamill D. C., "Power electronics: A field rich in nonlinear dynamics", in *Proc. Int. Workshop on Nonlinear Electronics Systems*, pp. 165-178, 1995.
- [3] Noroozian R., Abedi M., Gharehpetian G. B. And Hosseini S. H., "On-grid and Off-grid Operation of Multi-Input Single-Output DC/DC Converter based Fuel Cell Generation System", *Iranian Journal of Electrical and Electronic Engineering*, Vol. 5, No. 2, pp. 131-142, 2009.
- [4] Nagy I., "Nonlinear dynamics in power electronics", *Automatica journal*, Vol. 42, No. 3-4, pp. 117-132, July-Dec. 2001.
- [5] Abbasi A., Rostami M., Abdollahi J., Abbasi H. R. and Daneshmand H. N., "An analytical discrete model for evaluation the chaotic behaviour of boost converter under current control mode", *ISIEA09 Malaysia IEEE Conf.*, pp. 403-407, 2009.
- [6] Nemati A. and Pakdel M., "A New ZVZCS Isolated Dual Series Resonant DC-DC Converter with EMC Considerations", *Iranian Journal of Electrical and Electronic Engineering (IJEET)*, Vol. 6, No. 3, pp. 190-198, 2010.
- [7] Abbasi A., Rostami M., Abdollahi J. and Abbasi H. R., "An analytical discrete model for evaluation the chaotic behaviour of buck converter under current control mode", *ISIEA09 Malaysia IEEE Conf.*, pp. 112-116, 2009.
- [8] Robert B. and El Aroudi A., "Discrete time model of a multi-cell dc/dc converter: Nonlinear approach", *Elsevier Mathematics and Computers in Simulation*, Vol. 71, pp. 310-319, 2006.



- [9] Zheng Y. and Fu Y., "Effect of damage on bifurcation and chaos of viscoelastic plates", *Int. Journal of Nonlinear Sci. Numer. Simul.*, Vol. 6, No. 1, pp. 87-91, 2005.
- [10] Di Bernardo M. and Vasqua F., "Discrete-time maps for the analysis of bifurcations and chaos in DC/DC converters", *IEEE Transactions on Circuits and Systems*, Vol. 47, No. 2, pp. 130-143, 2000.
- [11] Tse C. K. and Di Bernardo M., "Complex behavior in switching power converters", *Proc. IEEE*, Vol. 90, No. 5, pp. 768-781, May 2002.
- [12] El Aroudi A., Debbat M., Giral R. and Martinez-Salamero L., "Quasi periodic route to chaos in DC/DC switching regulators", *Proceedings of the IEEE International Symposium on Industrial Electronics*, pp. 2310-2135, Pusan, Korea, June 2001.
- [13] Kousaka T., Ueta T., Ma Y. and Kawakami H., "Bifurcation analysis of a piecewise smooth system with nonlinear characteristics", *International Journal of Circuit Theory and Applications*, Vol. 33, No. 4, pp. 263-279, 2005.
- [14] Ruzbehani M., Zhou L. and Wang M., "Bifurcation diagram features of a dc-dc converter under current-mode control", *Elsevier, Chaos, Solitons and Fractals*, pp. 205-212, 2006.
- [15] Ott E., Grebogi C. and York J. A., "Controlling chaos", *Phys. Rev. Lett.*, Vol. 64, No. 11, pp. 1196-1199, 1990.
- [16] Grebogi C. and Lai Y. C., "Controlling chaos in high dimension", *IEEE Trans. Circuits Syst. I*, Vol. 44, No. 10, pp. 971-975, Oct. 1997.
- [17] Ditto W. L. and Spano M. L. and Linder J. F., "Techniques for the control of chaos", *Phys. D*, Vol. 86, No. 1-2, pp. 198-211, 1995.
- [18] Iu H. H. C. and Robert B., "Control of chaos in a PWM current-mode h-bridge inverter using time-delayed feedback", *IEEE Transactions on circuits and systems. I: fundamentals theory and applications*, Vol. 50, No. 8, pp. 1125-1129, August 2003.
- [19] Mohammadpour A., Mokhtari H. and Zolghadri M. R., "Control of Series Resonant Converter with Robust Performance Against Load and Power Circuit Components Uncertainties", *Iranian Journal of Electrical and Electronic Engineering (IJEED)*, Vol. 5, No. 4, pp. 244-252, 2009.
- [20] Chen G. and Yu X., "On time-delayed feedback control of chaotic systems", *IEEE Transactions on Fundamental Theory and Applications Circuits and Systems*, Vol. 46, No. 6, pp. 767-772, June 1999.
- [21] Yu X. and Chen G., "Tracking unstable periodic orbits in chaotic systems via time-delayed feedback control", *Proceedings of the 37th IEEE Conf.*, Vol. 2, pp. 1942-1945, Dec. 1998.
- [22] Guo L. W., Wei Z. L. and Ke W. J., "Self-Stable chaos control of dc-dc converter", *Chinese Phys*, Vol. 26, No. 3, pp. 30503-30506, 2009.
- [23] Banerjee S. and Verghese G. C., *Nonlinear phenomena in power electronics: Attractors bifurcations, chaos and nonlinear control*. New York: IEEE Press, 2001.
- [24] Kousaka T., Sakamoto K. and Ma Y., "Bifurcation and chaos in a PWM current-Mode h-bridge inverter", *National Conference on nonlinear Systems & Dynamics*, Feb. 2006.
- [25] Banerjee S., Parui S. and Gupta A., "Dynamical effects of missed switching in current-mode controlled dc-dc converters", *IEEE Trans. Circuits and Systems*, part II, Vol. 51, No. 12, pp. 649-654, 2004.
- [26] Zhang Z. and Bi Q., "Bifurcations of a generalized Camassa-Holm equation", *Int. J. Nonlinear Sci. Numer. Simul.*, pp. 81-86, 2005.
- [27] Wang L. and Xu M., "Property of period-doubling bifurcations", *Chaos, Solitons & Fractals*, Vol. 24, No. 2, pp. 527-532, 2005.
- [28] Emin Z. and Tong K. Y., "Ferroresonance experience in UK: simulations and measurements", *International Conference on Power Systems Transients (IPST)*, 2001.
- [29] Mukerjee R. N., Tanggawelu B., Ariffin E. A. and Balakrishnan M., "Indices for ferroresonance performance assessment in power distribution network", *International Conference on Power Systems Transients (IPST)*, 2003.
- [30] Mozaffari S., Sameti M. and Soudack A. C., "Effect of initial conditions on chaotic ferroresonance in power transformers", *IEE Proceedings Generation, Transmission and Distribution*, pp. 456-460, 1997.
- [31] Al-Anbari K., Ramanujam R., Saravanaselvan R. and Kuppusamy K., "Effect of iron core loss nonlinearity on chaotic ferroresonance in power transformers", *Electric Power Systems Research Elsevier journal*, Vol. 65, No. 1, pp. 1-12, 2003.
- [32] Pattanapakdee K. and Banmongkol C., "Failure of Riser Pole Arrester due to Station Service Transformer Ferroresonance", *International Conference on Power Systems Transients (IPST)*, June 2007.
- [33] Abbasi A., Rostami M., Radmanesh H. and Abbasi H., "Elimination of chaotic ferroresonance in power transformers including nonlinear core losses applying of neutral resistance", *EEEIC09, IEEE conference*, 2009.
- [34] Rezaei Zare A., Sanaye Pasand M., Mohseni H., Farhangi S. and Iravani R., "Analysis of Ferroresonance Modes in Power Transformers using Preisach-Type Hysteretic Magnetizing Inductance", *IEEE Transactions on Power Delivery*, Vol. 22, No. 2, pp. 919-929, April 2007.

- [35] Abbasi A., Rostami M., Radmanesh H. and Abbasi H. R., "Evaluation of Chaotic Ferroresonance in power transformers including Nonlinear Core Losses", *EEEIC09, IEEE conference*, 2009.
- [36] Araujo A. E. A., Soudack A. C. and Marti J. R., "Ferroresonance in power systems: chaotic behaviour", *IEE Proc.-C*, Vol. 140, No. 3, pp. 237-240, May 1993.
- [37] Chkravarthy S. K. and Nayar C. V., "Frequency-locked and quasi periodic (QP) oscillations in power systems", *IEEE Transactions on Power Delivery*, Vol. 13, pp. 560-569, 1997.
- [38] Mork B. A., "Five-legged wound core transformer model: derivation, parameters, implementation, and evaluation", *IEEE Transactions on Power Delivery*, Vol. 14, No. 4, pp. 1519-1526, 1999.
- [39] Rezaei Zare A., Mohseni H., Sanaye Pasand M., Farhangi S. and Iravani R., "Performance of various magnetic core models in comparison with the laboratory test results of a ferroresonance test on a 33 kV voltage transformer", *Power Engineering Society General Meeting*. 10.1109/PES.2006.1709624, 2006.
- [40] Neves W. L. A. and Dommel H., "On modeling iron core nonlinearities", *IEEE Transactions on Power Systems*, Vol. 8, No. 2, pp. 417-425, 1993.
- [41] Kavasseri G., "Analysis of subharmonic oscillations in a ferroresonant circuit", *Electrical Power and Energy Systems, Elsevier journal*, Vol. 28, No. 3, pp. 207-214, 2005.
- [42] Emin Z., Zahawi B. A. T., Tong Y. K. and Ugur M., "Quantification of the chaotic behavior of ferroresonant voltage transformer circuits", *IEEE Transactions on Circuits and Systems, Fundamental Theory and Applications*, Vol. 48, No. 6, pp. 757-760, June 2001.



**Hamid Reza Abbasi** received the B.S. degree in Electrical Eng. Department, Tehran University, Iran in 2009. Currently he is studying M.S.E. at Electrical Engineering Department of Iran University of Science and Technology, Tehran, Iran. His research interests are in the Application of Artificial Intelligence to Power System Control Design, Analyzing Chaos in

Power System and Chaos Control in Power System.



**Ahmad Ghoalmi** has received his B.S. degree in Electrical Engineering from IUST, Tehran, Iran, in 1975, the M.S.E and Ph. D. degrees in Electrical Engineering from UMIST, Manchester, England, in 1986 and 1989 respectively. He is currently an Associate professor in the Electrical Engineering Department of Iran University of Science and Technology, Tehran, Iran. His main

research activities are High Voltage Engineering, Electrical Insulation, Insulation Coordination, Transmission lines and Substations Planning.



**Mehrdad Rostami** born in 1965, Tehran, IRAN. He received BSc, MSc and Ph.D in Electrical engineering from Tehran Polytechnic University (AmirKabir), Tehran, Iran in 1988, 1991 and 2003 respectively. He is currently working as an Assistant professor and Head of Engineering Technology and Research Center of Shahed University, Tehran, IRAN. He

has been published more than 40 papers in international conferences and journals. He has been project manager of many industrial projects since 1990. Dr. Rostami is IEEE member.



**Atollah Abbasi** received the B.S. and M.S.E. degrees in Electrical Eng. Department, Shahed University, Iran in 2005 and 2008. His research interests are in the Application of Artificial Intelligence to Power System Control Design, Analyzing Chaos in Power System, Analyzing resonance and ferroresonance phenomena and

Chaos Control in Power System.