

# STUDY OF GAS ENVIRONMENT IMPACTS ON VOLUMETRIC COAL MATRIX CHANGES

F. Sereshki, S.A. Hosseini, N. Aziz & I. Porter

**Abstract:** *The Outburst can be defined as a sudden release of coal and rock accompanied by large quantities of gas into the underground coal mine workings which represents a major hazard in underground coal mines. Gas drainage has been proven to be successful in reducing outburst hazards by decreasing the in-situ gas pressure. One of aspect of gas drainage from coal seams is coal matrix volume changes. Current study is primarily concerned with experimental studies related to coal volume change (coal shrinkage) under various gas types and pressures. Two types of tests were conducted on each sample, the adsorption test for coal swelling and the desorption test for coal shrinkage. The gases used in the study were CH<sub>4</sub>, CO<sub>2</sub>, CH<sub>4</sub>/CO<sub>2</sub> (50-50% volume), and N<sub>2</sub>. In this research, tests were conducted with respect to volumetric change behavior in different gases and their corresponding comparative results were presented.*

**Keywords:** *Coal shrinkage, swelling, desorption test, drainage system, coal mine*

## 1. Introduction

The In recent decades, the subject of coal and gas outburst in underground coal mines has been a focus of interest in worldwide. Much of this interest has been the result of the alarming increase in outburst related incidents and associated fatalities particularly in China, Russia, Ukraine and other major coal producing countries[1].

The composition of the gas stored in coal is highly variable, ranging from pure methane to pure carbon dioxide [2]. These variations are mainly related to the geological structure and depth of the coal deposit [3]. Littke and Leythaeuser (1993) showed that there were three distinct pore systems of micropores (<50 Å), mesopores (50 to 500 Å) and macropores (500 Å to about 50 mm) [4]. The storage of methane in coal structure occurs in two different forms, firstly by sorption into pores and micro fractures, and free gas. Almost 95% of stored gas in coal is in the adsorbed state as a monomolecular layer on the surfaces of fissures cracks and cleavages and only a small

percentage (<5%) is in free state [5]. The level and easiness of gas sorption from coal seams is influenced by moisture, temperature, structure, porosity and a permeability of coal. Methane and other gases will flow out of the coal pores if there is a pressure gradient acting as a driving force. However, the easiness of gas removal from coal is dependent upon the type of the gas and coal petrography and according to [6], coal has higher permeability to methane than to carbon dioxide. Another aspect of gas removal from coal is coal matrix volume change. According to [7] the shrinkage of coal matrix associated to desorption opens up the cleats and results in an increase in coal permeability. Reference [ ] also noted that the degree of coal shrinkage with respect to overburden stresses can also influence coal porosity and permeability. Reference [8] showed that there was a linear relationship between the coal matrix volumetric strain and the quantity of gas released.

Accordingly, the program of study reported in this paper is intended to show the influence of gas type and pressure on the coal volumetric changes in different coal mines. The tests were made under various gas types and gas pressure changes. The permeability and volume change experiments were conducted in separate apparatus specifically designed and constructed for each test.

## 2. Methodology

### 2-1. Coal Sample Preparation

Core samples 50 mm in diameter were drilled out of the coal lumps collected from different locations as four different coalmines in Australia (Tahmoor, Metropolitan, Dartbrook and North Goonyella) and

---

*Paper first received April. 05, 2007, and in revised form Nov.24, 2008.*

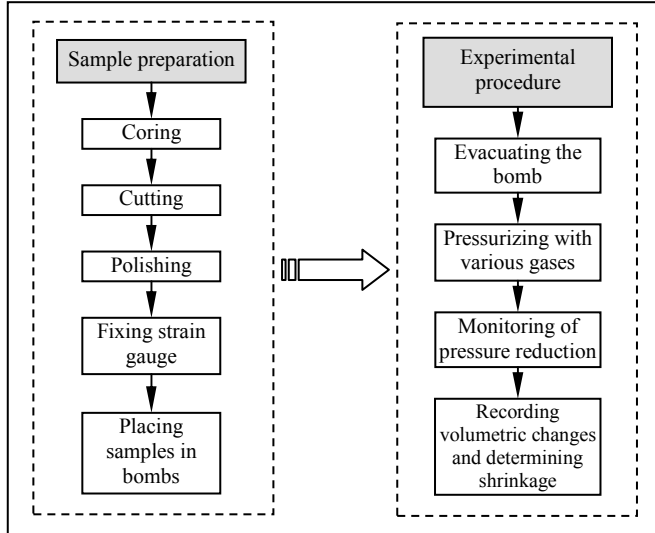
*F. Sereshki* is with the Department of Mining engineering and petroleum, Shahrood university of technology, Shahrood, iran. Farhang@shahroodut.ac.ir

*S.A. Hosseini* is a MSc student at the same Department. Hosseini.ma@gmail.com

*N. Aziz* is with the Department of Civil, Mining and environmental engineering, University of Wollongong, NWS, 2500, Australia, Naj@uow.edu.au

*I. Porter* is with the Department of Civil, Mining and environmental engineering, University of Wollongong, NWS, 2500, Australia, lan\_porter@uow.edu.au

Tabas coalmine in Iran. Prior to drilling the cores, each irregularly shaped coal lump was first cast in a regular shaped concrete block base to permit easy drilling. Figure 1 shows the flow diagram for the coal sample preparation and testing procedure.



**Fig. 1. Coal sample preparation and shrinkage testing stages [9]**

A diamond tipped core drill was used to drill the cores. The cored samples were then cut to 50 mm lengths using a circular saw. The ends of each core sample were cut, polished and ground flat with a lapping machine in accordance with the International Society of Rock Mechanics (ISRM) standards. Once the core samples were fully prepared they were re-immersed in water until the time of testing.

### 2-2. Sample Instrumentation

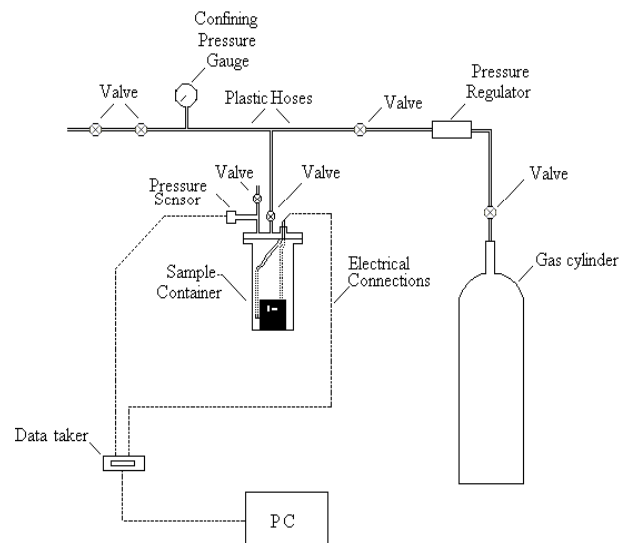
A set of four strain gauges was mounted at mid-height on each sample to monitor both the axial and radial strains in the coal sample. Two strain gauges were mounted parallel to the sample axis, but diametrically opposite. The other two were circumferentially glued around the sample and 180° apart. Figure 2 shows a typical specimen with instruments and wires attached, which were to be connected to the bomb lid terminals for data retrieval. A data-logger DT-500 (Data Taker brand) connected to a PC was used for data retrieval from the samples during the sorption process and subsequent analysis.

### 2-3. Sample Preconditioning and Testing

Volumetric matrix change or coal swelling / shrinkage tests were conducted in pressure vessels in an adsorption/desorption apparatus as shown in Figure 3 and described elsewhere by [10] and later by [11]. Pressure vessels, known as 'Bombs' (Figure 2) were modified to include individual pressure transducers. A total of 18 bombs were constructed for two sets of sorption apparatus, and one set of six bombs was subsequently modified and used for coal shrinkage testing.



**Fig. 2. Coal Sample with Instruments**



**Fig. 3. Schematic Diagram of Apparatus for Testing Volumetric Changes in Coal**

Coal samples were sealed in the bombs and evacuated for 24 hrs in order to remove any other gases in the coal. They were then pressurized with a predetermined gas type up to 3 MPa, which is typical of the gas pressures found in Australian coals, as measured by [10] in West Cliff Colliery. However, the Bulli seam gas pressure can reach up to 5 MPa, particularly in some parts of the seam near Tahmoor and in the now closed nearby Oakdale mine workings. The sample containers (bombs) were kept immersed in a constant temperature (25°C) controlled water bath, but were isolated from the water bath by copper sleeves to keep them dry. Two types of test were made on each coal sample:

1. Adsorption test to determine the volumetric swelling of coal in different gases and pressures.
2. Desorption test for coal volume shrinkage in different gases and pressures.

The sample was pressurized to 3MPa and then the gas was discharged in incremental steps of 0.5 MPa every 100 minutes. Changes in the volume of the coal were monitored and automatically recorded at regular

intervals during the sorption and desorption process via the Data-Taker and PC.

Following completion of one set of tests for a given gas type, the bomb was evacuated and the procedure repeated for the other gases. Changes in the volume of the coal matrix were calculated using the average of the two strains in the axial and radial directions. The calculation procedure was [9]:

$$V = \pi \times r^2 \times h \tag{1}$$

$$\ln(V) = \ln(\pi \times r^2 \times h) \tag{2}$$

$$\ln(V) = \ln \pi + 2 \ln r + \ln h \tag{3}$$

As  $\ln \pi = cte$ . then 
$$\tag{4}$$

$$\frac{\Delta V}{V} = 2 \left( \frac{\Delta r}{r} \right) + \left( \frac{\Delta h}{h} \right) \tag{5}$$

Where

$h$  = the height of sample (cm)

$r$  = the radius of sample (cm)

$V$  = the volume of sample (cm<sup>3</sup>)

$\Delta V/V$  = volumetric strain (dimensionless)

$\Delta r/r$  = Average radial strain (dimensionless)

$\Delta h/h$  = Average axial strain (dimensionless).

### 3. Volumetric Change Due to Adsorption— Results and Discussion

Figures 4 to 7 show the volumetric strain variations versus time for Tabas coal samples in different gas environments. It can be observed that there are some variations in the volumetric change profiles for different samples tested under the same gas type and gas pressure. For example, at a 3 MPa gas pressure level (Figure 4), there is a difference in the volumetric strain of the order of 20% between Tabas coal samples 1 and 2, while the other samples (samples 3, 4 and 5), lie in between these two extremes. This is not unexpected, as the coal samples with very different volumetric strains may have come from different places in the long section (different horizons) cored out of the coal lumps.

By comparing the volumetric strain curves it was found that CO<sub>2</sub> gas caused the highest coal volume expansion and N<sub>2</sub> the lowest (Figures 4 to 7). This trend was the same for all the coals tested. The low level of influence of N<sub>2</sub> gas can be explained by referring to its lack of attraction to coal. However the molecular size of nitrogen (36Å) is smaller than the methane (38Å) [12] for example suggesting that it can reach to the smaller pores, but because there isn't any attraction between the pore walls and the N<sub>2</sub> molecule, the sorption rate of nitrogen will therefore be low.

Also, [13] mentioned that carbon dioxide induces great swelling effect in the coal structure since its rate of sorbed and free gas is higher than the other gases such as nitrogen. In the case of the coal matrix higher affinity for carbon dioxide, [14] explained, "Adsorption of carbon dioxide by the coal matrix is strengthening by the quadruple moment of the carbon dioxide molecule interacting with the oxygen present on the coal (carbon) surface". It can be concluded that, in the volume change measurements of coal with sorption of different gases, both size of the gas molecules and their relationship with the coal have to be considered. More than 90% of the total increase in volume for any coal type occurred during the First 300 min after gas pressurization; however this period varied with the gas type used. It occurred at a faster rate in CH<sub>4</sub>, followed by the CO<sub>2</sub>/CH<sub>4</sub> mixture, then CO<sub>2</sub> and finally N<sub>2</sub>. The volume increase for Tabas coal in CH<sub>4</sub> was around 0.08%, and in CO<sub>2</sub> it was around 0.1%.

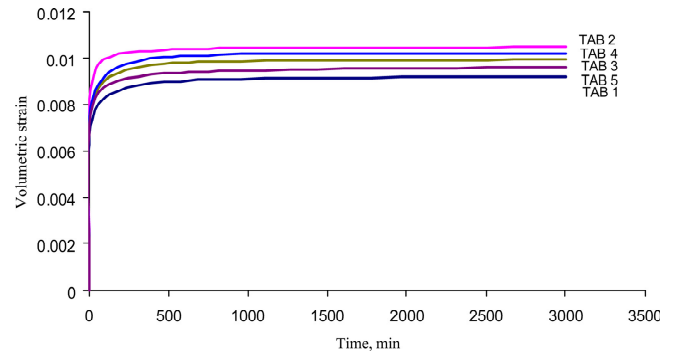


Fig. 4. Volumetric strains for Tabas coal at 3 MPa in CO<sub>2</sub>

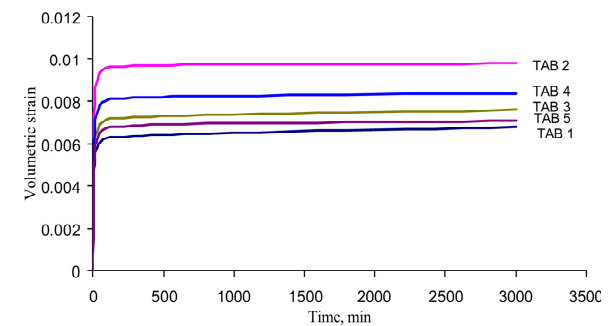


Fig. 5. Volumetric strains for Tabas coal at 3 MPa in CH<sub>4</sub>

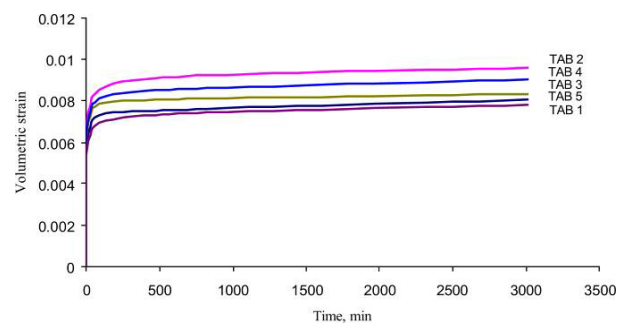
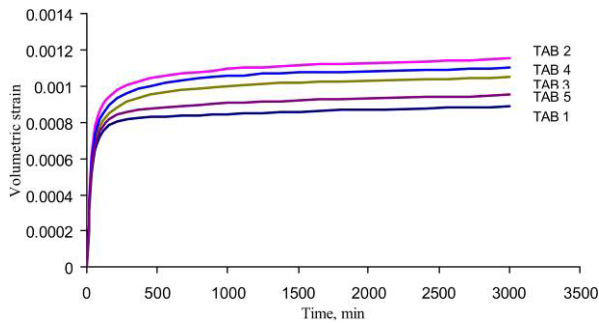


Fig. 6. Volumetric strains for Tabas coal at 3 MPa in a 1:1 CH<sub>4</sub>/CO<sub>2</sub> mixture



**Fig. 7. Volumetric strains for Tabas coal in  $N_2$  gas at 3 MPa**

The significance of the coal swelling profiles with respect to time is that it clearly demonstrates that much of the coal matrix expansion occurs in the early stages of gas application, and is in line with the general sorption isotherms used for gas sorption as discussed by [10]. The volumetric strain due to sorption of the  $CH_4/CO_2$  mixture was closer to that of carbon dioxide rather than that of methane; this is because of the greater affinity of  $CO_2$  on coal. A relatively greater variation of volume change “swelling” in coal samples with respect to changes in gas type and coal can be attributed to the coal matrix structure.

The sorption capacity of coal appears to depend on its porous configuration, especially with respect to the micropores, as reported by various researchers. Reference [15] stated, “Coals have a fairly complex and variable microstructure depending upon their metamorphic state (rank) and the percentage of each of the petrographic components”.

Reference [16] showed a clear connection between degree of metamorphism and gas sorption capacity of coals. Furthermore [17] demonstrated that pore volume distribution is dependent upon the rank of coal. Therefore it can be explained that rank and macerals dictate the development of the micropores in the coal matrix.

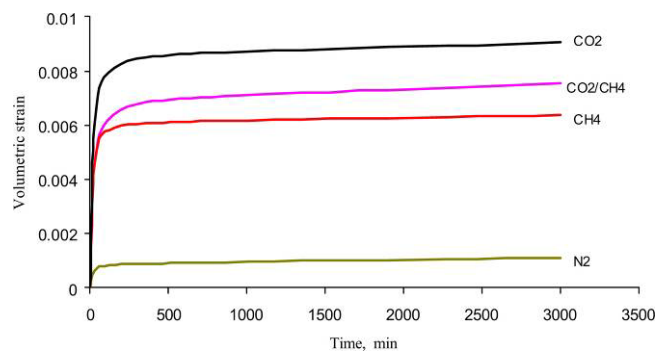
When describing the differences between sorption rates, the discussion refers to the influence of maceral composition and mineral matter within the coal matrix.

The volumetric strain curves of all the coal samples which were tested from the Tabas mine indicated that the higher the level of vitrinite maceral the greater the magnitude of strain. Many researchers have indicated that coal macerals influence gas sorption. These include [18], [19], [20], [21] who observed that vitrinite-rich coals have a higher adsorption rate and a higher amount of swelling than inertinite-rich coals of equivalent rank. However, [22] mentioned that “poor or no correlation may be found between adsorption capacity and maceral composition.”

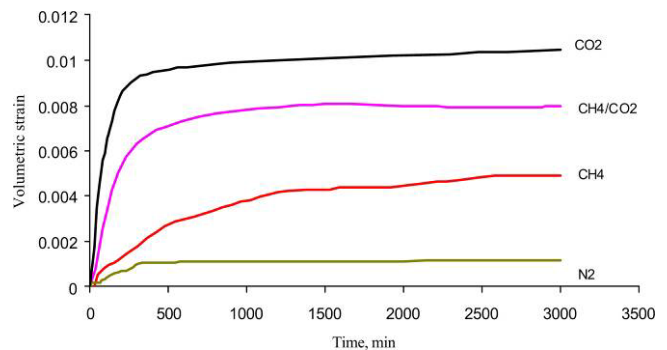
The role of mineral matter in sorption is important. Mineral matter causes a reduction in gas sorption as it is not an adsorbent for the coal gases. This was clearly evident in the lower value of volumetric strain for the Dartbrook Wynne Seam coal (Figure 8), a coal that was relatively high in mineral matter in comparison to

average values for the other coals. Thus higher amounts of mineral matter result in lower volumetric strain. The average values of volumetric strain profiles in different gases for Tabas coal and other coal samples from Dartbrook, Tahmoor, Metropolitan, Tabas and North Goonyella are shown in Figures 8 to 12 respectively.

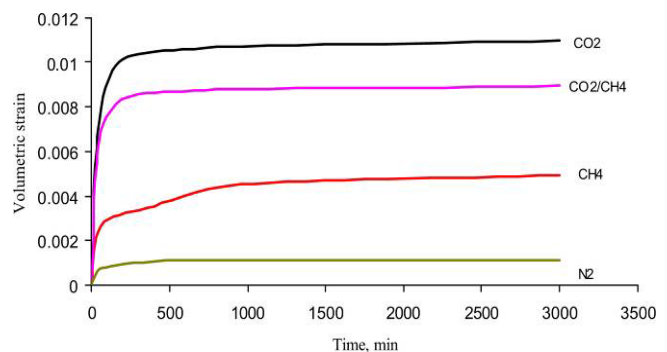
For coal samples from North Goonyella (NGO) the average volumetric change due to carbon dioxide sorption was about ten times higher than that due to nitrogen, and was approximately 2 and 1.2 times higher than for methane and the  $CH_4/CO_2$  mixture, respectively.



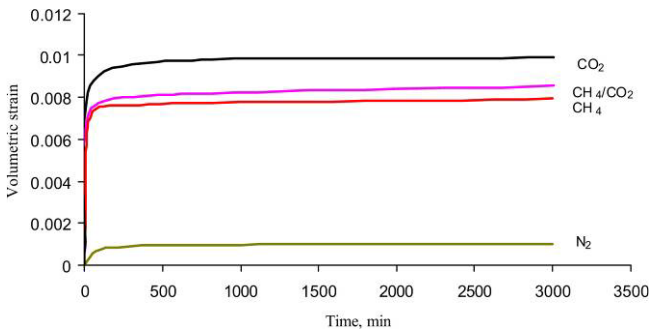
**Fig. 8. The average volumetric strain of Dartbrook coal associated with adsorption at 3 MPa for different gases**



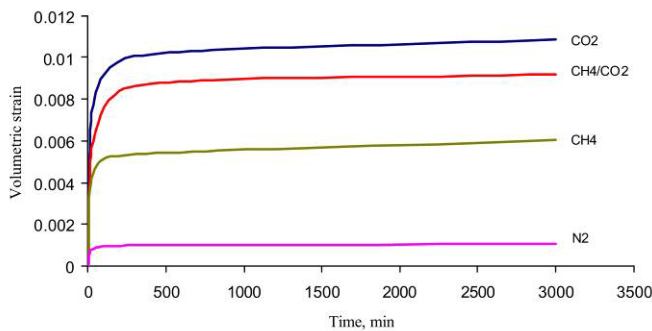
**Fig. 9. The average volumetric strain of Tahmoor coal associated with adsorption at 3 MPa for different gases**



**Fig.10. The average volumetric strain of Metropolitan coal associated with adsorption at 3 MPa for different gases**



**Fig. 11. The average volumetric strain of Tabas coal associated with adsorption at 3 MPa for different gases**



**Fig. 12. The average volumetric strain of North Goonyella Coal (NGO) associated with adsorption at 3 MPa for different gases**

The ratio of the volumetric strain changes of  $\text{CO}_2 / \text{N}_2$  measured for Tahmoor (TAH) coal samples was around 22, and for Dartbrook (DAR) coal it was eight (8). By comparing Figures 9 and 10 with the other sorption figures, it can be seen that the coal samples from the Bulli coal seam (Tahmoor and Metropolitan Collieries) had the least expansion in the methane gas environment. The ratio of their expansion for methane compared to carbon dioxide was 2.5 for Metropolitan coal samples (MMP) and 2 for Tahmoor coal samples (TAH).

**4. Coal shrinkage by Desorption**

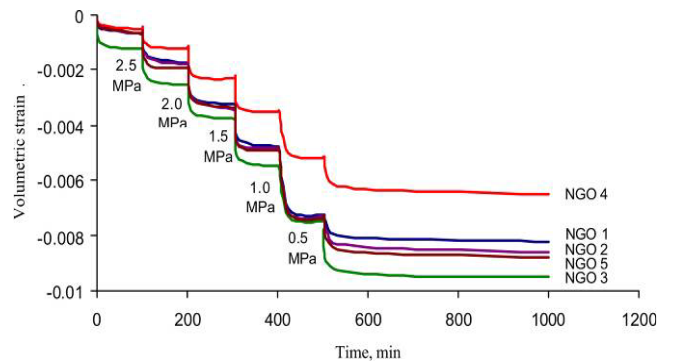
In the second series of tests the strains due to desorption were measured. Incremental gas pressure reduction and its impact on various coal samples from North Goonyella (pressurized to 3 MPa) are shown in Figures 13 to 17, shows the average values for all North Goonyella samples. The trend of the incremental decrease in coal volume as a result of gas pressure drop is similar for all five samples. It is clear from Figure 18 that for any given pressure level the volume change is highest in a carbon dioxide environment, followed by the mixture  $\text{CO}_2/\text{CH}_4$ , then  $\text{CH}_4$  and  $\text{N}_2$ . The incremental reductions in gas pressure were maintained constant at 0.5 MPa. The rate and amount of volumetric change over the same time period were greater at lower pressures. A suitable

explanation is that at lower pressure levels the sorbed gas in coal can desorb more easily than at higher pressures; also, the inherent coal pores and microfractures open up at the lower pressures [23].

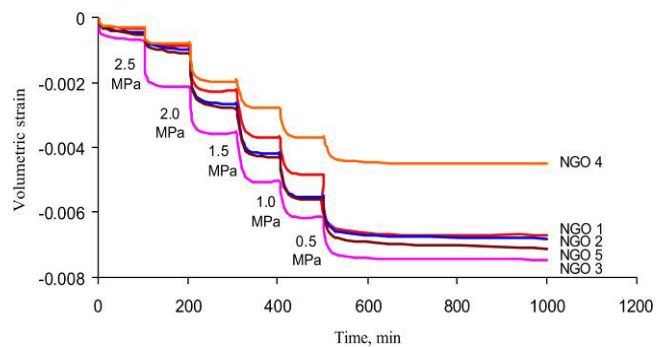
The volumetric strains were higher for carbon dioxide than methane and nitrogen. Thus the shrinkage due to carbon dioxide was more than with the other gases. By comparing the desorption diagrams for the  $\text{CH}_4/\text{CO}_2$  mixture with desorption diagrams for  $\text{CH}_4$  and  $\text{CO}_2$ , desorption of the mixture can be divided into two stages. Initially the volumetric strains for the mixture were very similar to  $\text{CH}_4$  strains.

In the second stage, the mixed gas behaved in the same way as  $\text{CO}_2$ . This suggests that desorption of methane is more rapid than that of carbon dioxide, even in mixtures.

This implication can be further justified by looking at the ratio of  $\text{CO}_2/\text{CH}_4$ , which in the initial stages of desorption was low and in the later stages had increased; it confirms [15] and [20] findings, which showed that during  $\text{CH}_4/\text{CO}_2$  mixture desorption from high pressure to low pressure,  $\text{CH}_4$  is preferentially released and  $\text{CO}_2$  preferentially retained by the coal. This suggests an explanation for the outburst phenomena, where in the early stage of outburst methane gas is the predominant gas and in the later stages the vast majority of the gas will be carbon dioxide.

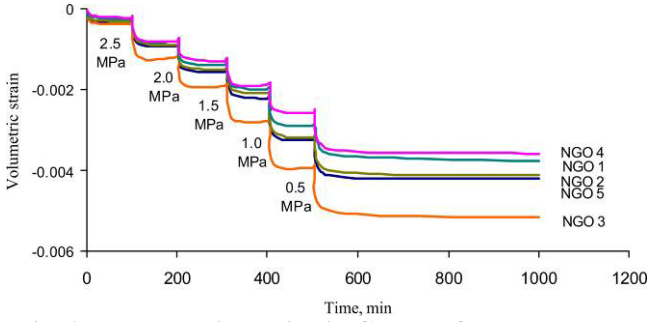


**Fig. 13. Volumetric strains in  $\text{CO}_2$  for pressure reductions of 0.5 MPa from 3 MPa for North Goonyella samples**

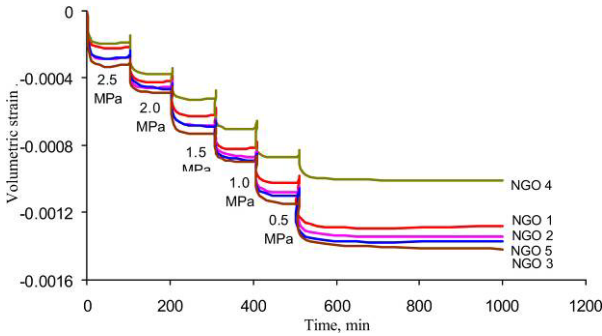


**Fig. 14. Volumetric strains in mixed  $\text{CH}_4/\text{CO}_2$  for pressure reductions of 0.5 MPa from 3 MPa for North Goonyella samples**

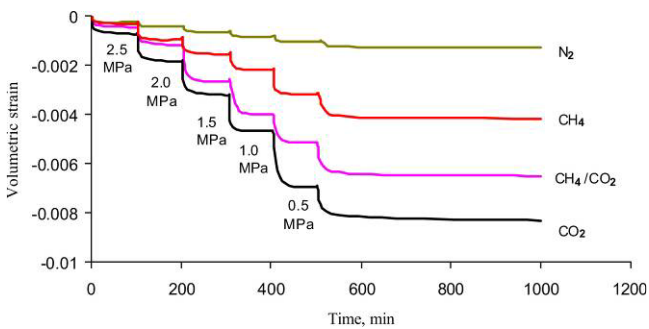




**Fig. 15. Volumetric strains in CH<sub>4</sub> gas for pressure reductions of 0.5 MPa from 3 MPa for North Goonyella samples**



**Fig. 16. Volumetric strains in N<sub>2</sub> gas for pressure reductions of 0.5 MPa from 3 MPa for North Goonyella samples**



**Fig. 17. Average volumetric strains for various gases for pressure reductions of 0.5 MPa from 3 MPa for North Goonyella samples**

The shrinkage coefficient ( $C_m$ ) is defined as the rate of change of the coal matrix volume to the change in gas pressure and is given by [1]:

$$C_m = \frac{1}{V_m} = \left( \frac{dV_m}{dp} \right) \quad (5)$$

Where:

$V_m$  = Matrix volume, m<sup>3</sup>

$dV_m$  = Change in volume, m<sup>3</sup>

$dP$  = Change in applied pressure, MPa

$C_m$  = Shrinkage coefficient, MPa<sup>-1</sup>

However, the simple way to determine ( $C_m$ ) is from the slope of the volumetric strain versus gas pressure plot. The volumetric strains were plotted with respect to

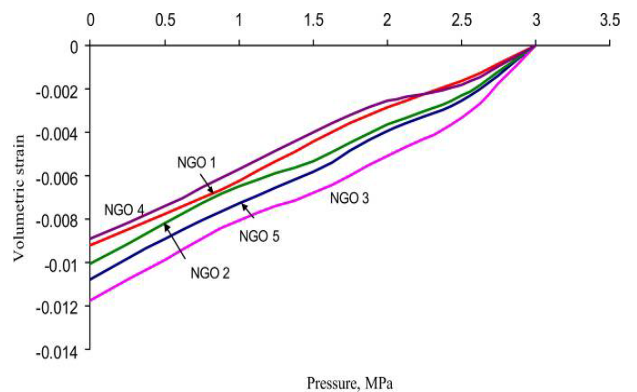
decreasing gas pressures by allowing desorption to reach near equilibrium at each stage.

According to Figures 18, as a general rule, the shrinkage coefficient increases with decreasing pressure. Table 1 shows the values of the shrinkage coefficient ( $C_m$ ) for the various coal types in different gas sorption/desorption environments.

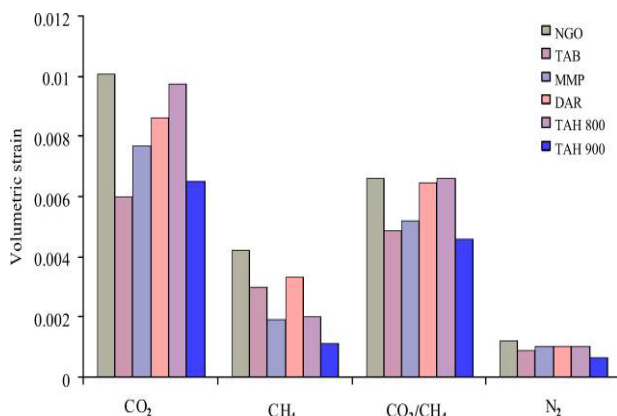
These values clearly show the effects of variations of the matrix structure and composition of various coal types on  $C_m$ .

**Tab. 1. Shrinkage coefficients (MPa<sup>-1</sup>) for samples tested.**

Coal samples	CO <sub>2</sub>	CH <sub>4</sub>	CH <sub>4</sub> /CO <sub>2</sub>	N <sub>2</sub>
NGO 1	0.0092	0.0044	0.0067	0.0012
NGO 2	0.0099	0.0049	0.0070	0.0013
NGO 3	0.0118	0.0054	0.0081	0.0014
NGO 4	0.0087	0.0035	0.0051	0.0010
NGO 5	0.0108	0.0031	0.0061	0.0013
TAB 1	0.0047	0.0021	0.0037	0.0008
TAB 2	0.0073	0.0041	0.0059	0.0011
TAB 3	0.0058	0.0029	0.0000	0.0009
TAB 4	0.0067	0.0033	0.0052	0.0010
TAB 5	0.0055	0.0026	0.0046	0.0008
MMP 1	0.0060	0.0016	0.0061	0.0009
MMP 2	0.0089	0.0022	0.0048	0.0012
MMP 3	0.0082	0.0020	0.0051	0.0011
MMP 4	0.0072	0.0017	0.0055	0.0010
MMP 5	0.0083	0.0021	0.0046	0.0011
DAR 1	0.0099	0.0039	0.0052	0.0012
DAR 2	0.0082	0.0031	0.0080	0.0010
DAR 3	0.0085	0.0034	0.0064	0.0010
DAR 4	0.0090	0.0035	0.0056	0.0011
DAR 5	0.0075	0.0029	0.0072	0.0010
TAH 1	0.0098	0.0020	0.0065	0.0011
TAH 2	0.0073	0.0013	0.0051	0.0007
TAH 3	0.0051	0.0010	0.0040	0.0007
TAH 4	0.0091	0.0018	0.0053	0.0010
TAH 5	0.0080	0.0017	0.0053	0.0009
TAH 7	0.0114	0.0023	0.0078	0.0012
TAH 8	0.0105	0.0022	0.0075	0.0011
TAH 9	0.0072	0.0011	0.0048	0.0007



**Fig. 18. Volumetric strain of different North Goonyella coal matrix samples with decreasing CO<sub>2</sub> gas pressure from 3MPa to absolute pressure**



**Fig. 19. Average volumetric strains of tested coal samples**

The shrinkage coefficients of Metropolitan coal samples were approximately the same as for Tahmoor coal samples, which in both mines were extracted from the Bulli coal seam. Obviously, the variation in shrinkage coefficient is influenced by the coal composition, particularly, the variation in mineral matter. It can be clearly seen that for all gas environments the coal matrix volume shrinks with reduction in pressure. As can be seen from Figure 19 for all tested samples the highest amount of volumetric strain was caused by carbon dioxide and the least by nitrogen.

Also it can be deduced that the volumetric strain for CO<sub>2</sub>/CH<sub>4</sub> is closer to that of CO<sub>2</sub> than to that of CH<sub>4</sub>. Nitrogen as a neutral gas does not have much effect on the coal volume.

## 5. Conclusions

The experimental work reported in this investigation demonstrated the influence of increased coal sorption on coal volume changes. The level of coal shrinkage is affected by the type of gas desorbed. Carbon dioxide appears to have the greatest influence on the matrix and nitrogen the least. This is understandable in view of the fact that carbon dioxide has a greater affinity to coal than the other gases. As well as the magnitude of shrinkage, the rate of shrinkage was also found to be influenced by the type of gas and the applied pressure. All mines' coal samples showed approximately the same behavior, with Metropolitan coal samples having a greater average rate of shrinkage than the other coal samples. Such variation can be attributed to the coal composition.

## 6. Acknowledgment

The assistance provided by the mining engineering technical staff of university of Wollongong, Alan Grant, Ian Laird and Bob Rowland is appreciated. Finally the authors wish to acknowledge the support provided by management and staff of both Tabas coal company, Iran and North Goonyella mine, Queensland,

Australia by providing coal samples for the experimental work in this project.

## References

- [1] Harvey, C.R. *Analysis and Management of Outbursts with Particular Reference to the Bulli Coal Seam*, PhD Thesis in School of Civil, Mining and Environment Engineering, Faculty of Engineering, University of Wollongong, 2001 p. 210.
- [2] Santillan, M., *Underground Desgasification and Coal Mine Methane Projects at Minales Monclova*, Minales Monclova, S.A. de C.V, 2004.
- [3] Shi, J.Q., Durucan, S., *Modeling of Enhanced Methane Recovery and CO<sub>2</sub> Sequestration in Deep Coal Seams: the Impact of Coal Matrix Shrinkage / Swelling on Cleat Permeability*, International coal bed methane Symposium, Tuscaloosa, Alabama, 2003, pp 0343 (1-12)
- [4] Laubach, S.E., Marrett, R.A., Olson, J.E., Scott, A.R., *Characteristics and Origins of Coal Cleat: a Review*, Int. J. Coal Geol., Vol. 35, 1998 pp. 175–207.
- [5] Gray, I., *Stress, gas, Water and Permeability - Their Interdependence and Relation to Outbursting*, International symposium - cum- workshop on Management and control of high gas emissions and outbursts in underground coal mines, Lama, R. D. (ed.), Wollongong, NSW, Australia, 1995, pp 331-334.
- [6] Bartosiewicz, H., Hargraves, A.J., *Gas Properties of Australian Coal*, Proc.Australas. Inst. Min. Metall., Vol. 290, 1985 pp 71-77
- [7] Gray, I., *Reservoir Engineering in Coal Seams: Part1- The physical process of gas storage and movement in coal seams*, 1987.
- [8] Harpalani, S., Chen, G., *Effects of Gas Production on Porosity and Permeability of Coal*, Symposium on coalbed methane research and development in Australia, (Beamish, B. B. and Gamson P. D. (eds.), James cook University of North Queensland, Townsville, Australia, 1992, pp 67-79.
- [9] Sereshki, F., *Improving Coal Mine Safety by Identifying Factors That Influence the sudden Release of Gases in Outburst Prone Zones*, Mining department for the degree PhD, School of Civil, Mining and Environmental Engineering, University of Wollongong, 2005
- [10] Lama, R.D., Bartosiewicz, H., *Determination of Gas Content of Coal Seams, Seam Gas Drainage with particular Reference to the Working Seam*, Hargraves, A. J. (ed.), The Australian Institute of mining and metallurgy, Illawara Branch, University of Wollongong, 1982, pp 36-52.

- [1] Aziz, N.I., Ming-Li, W., *The Effect of Sorbed Gas on the Strength of Coal, an Experimental Study*, Geotechnical and Geological Engineering, Vol. 17, 1999, pp. 387- 402.
- [12] Kaye, G.W.C., Laby, T.H., *Table of Physical and Chemical Constants and some Mathematical Functions*, Longmans, Green and Co Ltd, London, 1966 249p.
- [13] Rodrigues, C.F., Lemos de Sousa, M.L., *The Measurement of coal Porosity with Different Gases*, International Journal of Coal Geology, Vol 48 2002, pp. 245- 251.
- [14] Deitz, V.R., Carpenter, F.G., Arnold, R.G., *Interaction of Carbon Dioxide with Carbon Adsorbents Below 400 °C*, Carbon, Vol. 1, 1964, pp 245-254.
- [15] Lama, R.D., *Adsorption and Desorption of Mixed Gases on Coal and Their Implications in Mine Ventilation*, Fourth international mine ventilation congress, Brisbane, Qld, Australia, 1988, pp. 161-174.
- [16] Ettinger, I.L., Lidin, G.D., Dimitiev, A.M., Shaupachina, E.S., *Systematic Handbook for the Determination of the Methane Content of Coal Seams From the Seam Gas Pressure and the Methane Capacity of coal*, USBM Translation No. 1501 1958
- [17] Gan, H., Nandi, S.P., Walker, P.L.Jr., *Nature of the porosity in American coals*, Fuel, Vol. 51 1972 pp 272-277.
- [18] Ettinger, I.L., Eremin, I., Zimakov, B., Yanovskaya, M., *Natural Factors Influencing Coal Sorption Properties, (I) Petrography and sorption properties of coals*, Fuel, Vol. 45, 1966 pp 267-275.
- [19] Clarkson and Bustin, *Variation in Permeability with Lithotype and Maceral Composition of Cretaceous Coals of the Canadian Cordillera*, International Journal of Coal Geology, Vol. 33, 1997 pp. 135- 151.
- [20] Crosdale, P.J., Beamish, B.B., Valix, M., *Coalbed Methane Sorption Related to Coal Composition*, International Journal of Coal Geology, Vol. 35 1998, pp. 147- 158.
- [2] Crosdale, P.J., Beamish, B.B., *Methane Diffusivity at South Bulli (NSW) and Central (Qld) Collieries in Relation to Coal Maceral Composition*, International symposium - cum- workshop on Management and control of high gas emissions and outbursts in underground coal mines, Lama, R. D. (ed.), Wollongong, NSW, Australia, 1995, pp 363-367
- [22] Faiz, M.M., Aziz, N.I., Hutton, A.C., Jones, B.G., *Porosity and Gas Sorption Capacity of Some Eastern Australian Coals in relation to coal Rank and Composition, Symposium on Coalbed Methane Research and development in Australia*, Townsville, Australia, 1992, pp 9-13.
- [23] Harpalani, S., Chen, G., *Effects of Gas Production on Porosity and Permeability of coal*, *Symposium on Coalbed Methane Research and Development in Australia*, (Beamish, B. B. and Gamson P. D. (eds.), James cook University of North Queensland, Townsville, Australia, 1992, pp. 67-79