

# DESIGN AND PERFORMANCE TESTS OF A MOBILE MECHANICAL MANIPULATOR

M. Habibnejad Korayem & A. Nakhaei

**Abstract:** Mobile mechanical manipulators are one of the automation aspects which were revealed in last years of twentieth century. These machines assume the responsibility of human and gradually expand the domain of their activities in industry. This paper is a presentation of the Sweeper Robot designed in the Robotic Laboratory of Iran University of Science and Technology. The original design of this robot allowing to its gripper to constantly remain parallel to the ground is presented. The dynamic and kinematical models of the robot have been computed. A software was developed in MATLAB to validate the kinematical and dynamic models of the robot by comparison with the experimental results. Once the robot was built and its systematic odometric error estimated by experiment, a control scheme for linear motions was developed to deal with this error. The approach is based on the introduction of an initial rectifying offset motion before starting the linear motion. Eventually, classical line tracking and image processing algorithms were used to complete our robot and the efficiency of our design to achieve its mission in picking and placing different objects according to various algorithms.

**Keywords:** Mobile Manipulator, Dynamics and Kinematics, Design, Performance

## 1. Introduction

Common problems to design a robot are the mechanical design of the robot, motion planning, motion control and perception. Presenting a comprehensive overview of the literature in these different fields is a challenge for itself. One of the most important steps in designing a mobile robot is its kinematical and dynamic analysis. In 1986, Muir and Neuman introduced Jacobian matrix for kinematic analyses [1]. Alexander and Maddocks modeled a robot as a rigid body on some wheels [2]. Campion used Lagrange equations for dynamic modeling of robot [3]. Rajagapalan considered slip between wheels and ground to analyze kinematic model of mobile manipulators [4].

Estimating the robot position and related experimental tests and measuring the errors are very important in robotics. Many methods have been introduced to measure and calibrate the robot errors. Chenavier and Crowley used **absolute** and **relative** method to estimate the robot position [5]. Borenstein and Feng suggested a benchmark test for measuring odometry

errors in mobile robots [6]. Borenstein and Evans designed "OmniMate" mobile robot which was able to detect and correct odometry errors without external references [7].

This paper presents the design and building of an autonomous mobile manipulator which is capable of recognizing different objects and taking them to predetermined places. A two wheeled mobile manipulator with two grippers, enabling the robot to carry two objects simultaneously, was designed for this purpose [8]. Section 2 introduces a mechanical description of the mobile manipulator including its original gripper. In Section 3, the kinematical and dynamic analyses and computation of the inverse kinematical of the robot are presented. The programs developed in MATLAB, which helped us in design and simulation. The electrical parts, hardware and the control algorithms implemented on them, which allow the motion and the control of the robot are presented in Sections 4 and 5. In Section 6, the test results are analyzed statistically and the systematic odometric errors are estimated, qualitatively as well as quantitatively. Based on this analyze, a control scheme for linear motion is developed and its validity is verified by experiment.

## 2. Description of Mechanical System

Our mission was to design and build of an autonomous mobile manipulator which is capable of recognizing different objects according to their colors

---

*Paper first received July. 10, 2007 and in revised form Sep. 05, 2009.*

M. Habibnejad is with the Robotic Research Lab, Department of Mechanical Engineering, Iran University of Science and Technology, Narmac, Tehran, Iran. hkorayem@iust.ac.ir .

A. Nakhaei is with the Robotic Research Lab, Department of Mechanical Engineering, Iran University of Science and Technology, Narmac, Tehran

and taking them to predetermined places according to various algorithms, in fact, designing an intelligent programmable robot for picking and placing objects. There are many important factors in designing this robot deserving attention as, speed, accuracy, and high performance.

The final concept was a differential mobile robot with a manipulator (two wheeled robot). The manipulator has one gripper. Furthermore there is a fixed gripper in front of the robot for further capability. These grippers enhance robot to carry 2 objects simultaneously and to pick up the object from various heights in its work space easily. Also, since the ability of high performance was an important factor in the design, a differential drive system was designed for the robot. Figs. 1 and 2 show the designed robot.

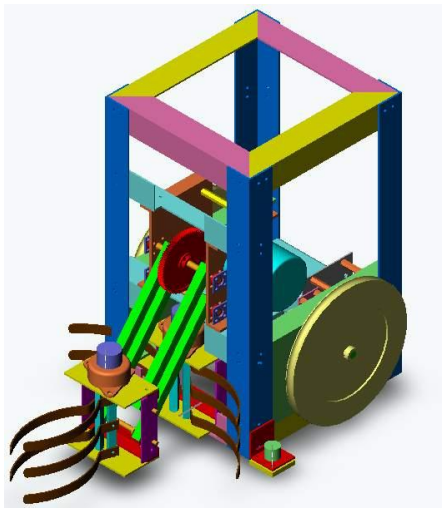

Fig. 1. The designed mobile robot in SolidWorks

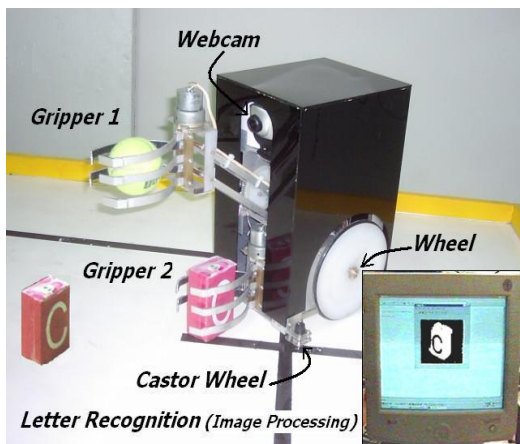

Fig. 2. The designed mobile manipulator after implementation

Two step motors are used to drive the robot and to increase the torque of motor, a gearbox with a ratio of 4:1 was designed for this unit. A gripper with 5 fingers is designed for grabbing objects. One DC motor drives this unit. The basic idea of this mechanism is rotating two groups of finger around two axes beside each other.

2-1. Arm

A one degree of freedom arm is designed for the robot. The arm is designed in such a way which keeps the gripper horizontal in all position. It helps the robot to carry or take the objects with higher accuracy. This mechanism is very helpful for taking the objects from various heights precisely. One step motor is used for rotating the arm. For increasing the motor torque, a gearbox with the ratio of 4:1 is used in this unit. One gripper, exactly the same as the fixed gripper is attached at the end of the arm for picking and placing objects. Fig. 3 shows the position of gripper on the arm.

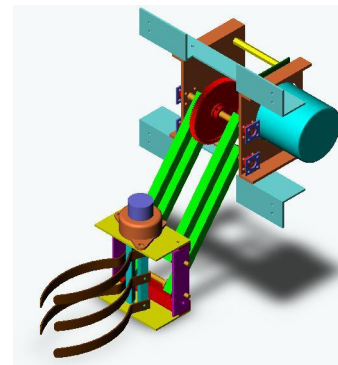

Fig. 3. Mechanical manipulator arm

3. Mathematical Model of the Mobile Robot

In order to control the robot, a mathematical model is required to show how each parameters affect the position of the end effectors. As it was mentioned in Section 2, there are two grippers in this robot. In other word, a mathematical model is required to show the effects of each motor angular displacement on each gripper. The direct kinematical model of the robot shows the relation of motor angular displacement with the position of each gripper and the robot itself. Based on the no slip assumption for wheels, the kinematical model for the gripper 1 which is fixed to the end of arm is as bellow [8]:

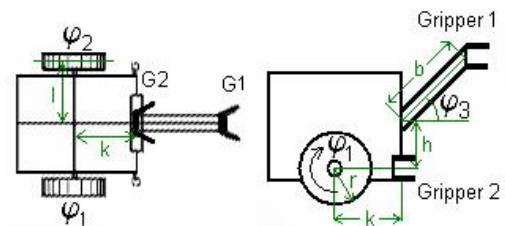

Fig. 4. Gripper position and related parameters

$$X_1(t) = x(t) + [k + b\cos(\phi_3(t))] \times \cos(\theta(t)) \tag{1}$$

$$Y_1(t) = y(t) + [k + b\cos(\phi_3(t))] \times \sin(\theta(t)) \tag{2}$$

$$Z_1(t) = r + h + b\sin(\phi_3(t)) \tag{3}$$

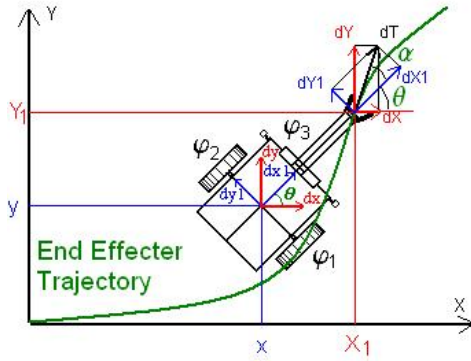

Fig. 5. 2D Parameters of robot position

For the gripper 2 which is fixed to the robot:

$$X_2(t) = x(t) + k \cos(\theta(t)) \quad (4)$$

$$Y_2(t) = y(t) + k \sin(\theta(t)) \quad (5)$$

$$Z_2(t) = cte \quad (6)$$

In the Inverse kinematical, the desired trajectory of gripper 2 is given and the angular displacement of each motor should be calculated. Based on Fig. 5, the flowchart of the inverse kinematical is as follows (Fig. 6):

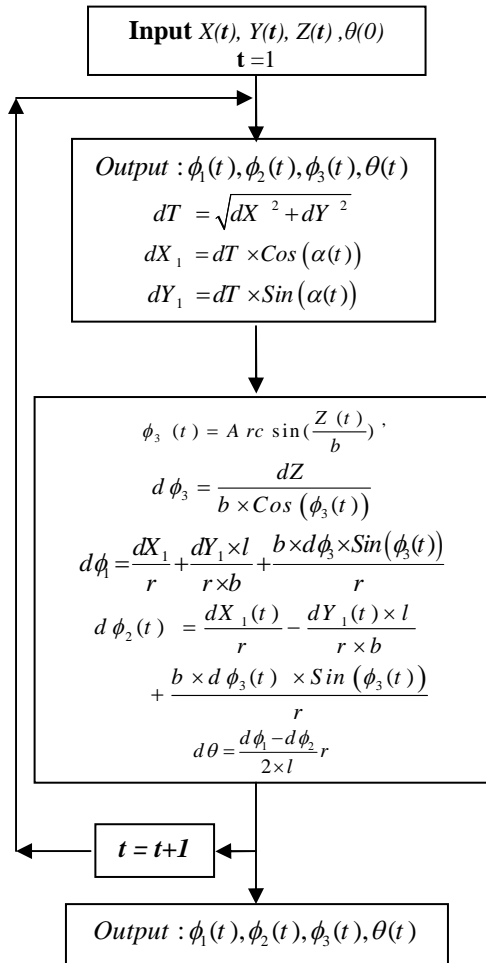

Fig. 6. The inverse kinematical block diagram of the robot

As the gripper 1 is directly attached to the robot and its position is fixed in relation with respect to the robot, the dynamic model is explained only for the gripper 1 which is attached to the arm. Lagrangian equation is used to calculate the dynamic model of the robot end effector. As each parameter  $(X_j, Y_j, Z_j, \theta)$  is a clear function of  $\phi_i$ , the dynamic equation is derived according to Lagrangian equation:

$$\begin{aligned} \tau_1(t) = & -\frac{M_{load} \times b \times k \times r^2}{4 \times l^2} \times \dot{\phi}_3(t) \times \sin(\phi_3(t)) - \frac{b^2 \times r^2 \times M_{load}}{8 \times l^2} \\ & \times \dot{\phi}_3(t) \times \sin(2\phi_3(t)) + (I_{Wheel,y} + r^2 \times M_{wheel}) \ddot{\phi}_1(t) + \left(\frac{r}{2 \times l}\right)^2 \\ & \times (I_{Base} + I_{Load} + 2I_{Wheel,z} + k^2 \times r^2 M_{Load}) \times (\ddot{\phi}_1(t) - \ddot{\phi}_2(t)) \\ & + 0.25 \times r^2 \times (\ddot{\phi}_1(t) + \ddot{\phi}_2(t)) - 0.5 \times r \times b \times \cos(\phi_3(t)) \times \dot{\phi}_3^2(t) \\ & - 0.5 \times b \times r \times M_{Load} \times \sin(\phi_3(t)) \times \ddot{\phi}_3(t) \end{aligned} \quad (7)$$

Required torques for motors 2 and 3 will be derived the same as motor 1.

#### 4. Description of Electronic System

Seven electronic boards are used in this robot as an internal control unit. The designer separated the boards from each other to make it easier to detect an error. There is one main board and all other are boards connected to this board directly or via a flat cable connectors. The internal micro controller which is used in this robot is PIC Microcontroller. This controller is used because of some benefits such as using C editor instead of assembly, having three internal timer and easy communication with PC via serial port. As a vision system is implemented and the images are processed in PC, it is necessary to have a communication between the PC and the internal controller (PIC). Delphi was used as control and image processing program of robot. The high level orders from Delphi are sent to PIC controller in robot via Serial Port. Serial Port is selected as the communication port because of some advantages such as longer cable communication in comparison with other ports, noise immunity and lower number of cable. Dynamic Link library (DLL) is used for communication via Serial Port.

#### 5. Description of Control Algorithm

By tracking a line on ground, the robot can find a predetermined path and get to the correct location. Also the robot can recognize various objects and their positions by image processing. It actually takes a photo and after some process, it recognizes the identity of the objects in the photo and their exact positions. According to the related position, it can pick up the objects. Then it finds the path and takes objects to predetermined places by tracking a line or image processing algorithm. The block diagram of the robot is shown in Fig. 7.

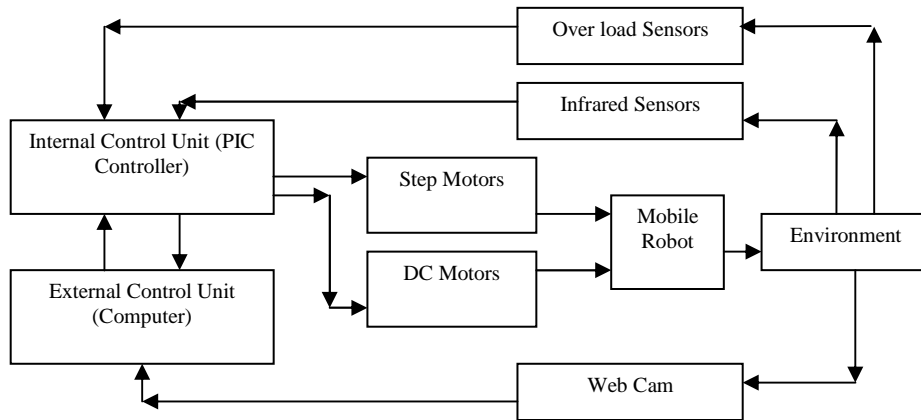

Fig. 7. The control block diagram of the robot

### 5-1. Line Tracking

One of the most important algorithm which is used in mobile robots as a feedback is line tracking. In line tracking algorithm, robot enables to follow a given path. The type of sensors which is used in line tracking depends on the type of the path. For example, for following a black line in a white ground, using infrared sensors is a good idea. The sensors which are used should be capable of sensing the path. This path would be a line, a wire or a magnetic field. In this robot, infrared sensors are used to sense black line on the white ground.

### 5-2. Image Processing

For image processing two items are very important:

- 1- Devise for capturing a frame
- 2- Algorithm for image processing

A high resolution web cam is used in this robot for capturing image. There are many types of software which can calculate the RGB or HIS of each pixel. The robot can recognize each objects and their related position with a simple color filtering algorithm.

## 6. Experimental Tests

Experiments are conducted to analyze the error sources and calibrate the error. Three tests were conducted to analyze the error sources in this robot and two tests were conducted to present a model for error distribution. In the first test, the aim was testing the robot in a straight path and checking its error in such a path. In the second test, the objective was analyzing the robot error in turning around itself. The third one was a combination of test 1 and test 2. In forth and fifth, two models for error distribution are presented in tracking circles and squares.

### 6-1. Testing the Robot in a Straight Line

In this test, although the robot has three degree of freedom, the test rig is designed in a way to program the robot to move straight (in a path with no curve) and check the error at the end point. According to the wheel dimension and gearbox ratio, 8535 pulse is needed for passing 1300 mm. The mean error in 20

tests was 40 mm in the left side of the desired path. For increasing accuracy, robot position was checked in 12 points along the path. Fig. 8 shows the result of the straight line test.

For compensating this error, a 1.8 degree clock wise [CW] pre rotation at the start point was beneficial. It decreases the mean error to almost zero in 20 tests as shown in Fig. 9.

Table.1. The mobile manipulator characteristics

| Characteristic    | Description/Unit                      |
|-------------------|---------------------------------------|
| Degree of freedom | 3                                     |
| Drive             | Via 2 Stepper Motor, 1.8 degree, 40 V |
| Gear ratio        | 4:1                                   |
| Control unit      | Interface between PIC and PC          |
| Sensor            | Infrared sensor                       |
| Power Supply      | External 12 DC                        |
| Base construction | Aluminum                              |
| Weight            | 5kg                                   |

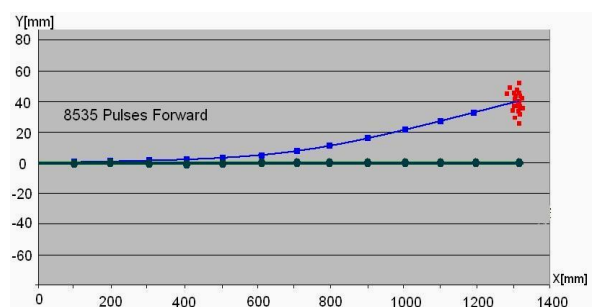

Fig. 8. Testing in a straight line before calibration.

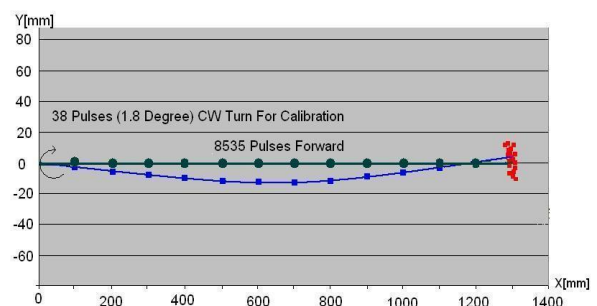

Fig. 9. Testing in a straight line after calibration.

**6-2. Testing the Robot in a Turn**

In this test, although the robot has three degree of freedom, two of them are neglected and the error in the pure rotation was tested. The robot was programmed to turn around itself in each step for 360 degree. The error was checked at the end of each rotation. According to the robot dimension and gearbox ratio, 7600 pulse was needed in each wheel for a 360 degree turn. The mean error shows that robot must rotate extra degrees (7.2 degree) to complete the desired turn. So, adding 100 pulses to the previous amount (7600 pulses) decrease the mean error to almost zero.

**6-3. Testing and Calibrating the Robot in Tracking a Square**

The third test is a combination of test1 and test2. In step one; robot is programmed to follow a specific path. This path is a square with the dimension of 1300 mm×1300 mm and the error was checked at the end point. This test was conducted for twenty times CCW and twenty times CW. In step two, some calibrations were done according to the results of test1 and test 2 and then the test was repeated. Figs. 10-a and 10-b show the statistical analysis of the results before and after the calibration in CW rotation, respectively. The resulted data were analyzed and some statistical parameters were calculated to show the effects of calibration on error distribution. The normal

distribution curve was plotted according to the following formula:

$$f(x) = \frac{1}{\delta\sqrt{2\pi}} e^{-0.5\left(\frac{x-\bar{e}}{\delta}\right)^2} \tag{8}$$

where,

$$\delta = \sqrt{\frac{\sum d_i^2}{n}}, \quad \bar{e} = \frac{\sum e}{n}, \quad d = e - \bar{e}.$$

The normal distribution curve of CW tests before and after calibration were shown in Figs. 10-a and 10-b, respectively. According to the normal distribution curve for each step, all resulted errors are categorized in three classes as bellows:

- a. error in which:  $r < \text{lower band}$
- b. error in which:  $\text{lower band} < r < \text{upper band}$
- c. error in which:  $r > \text{upper band}$

For all tests, the percent of data in each category was plotted in a pie chart to show the distribution of data in each category more clearly. Fig. 11 shows the pie charts of these distributions for CW tests before and after calibration. These figures show the effect of calibration on error scatter. Comparing Figs. 11-a and 11-b show that the percent of data in class c was decreased about 10 times which is the evidence of calibration efficiency in reducing error scatter.

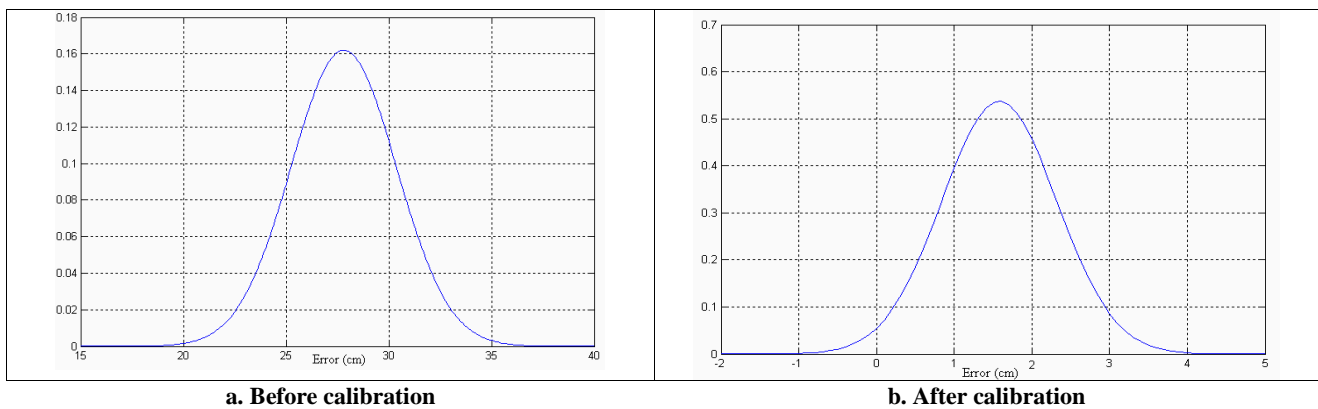

**Fig. 10. Normal distribution curve in CW turn**

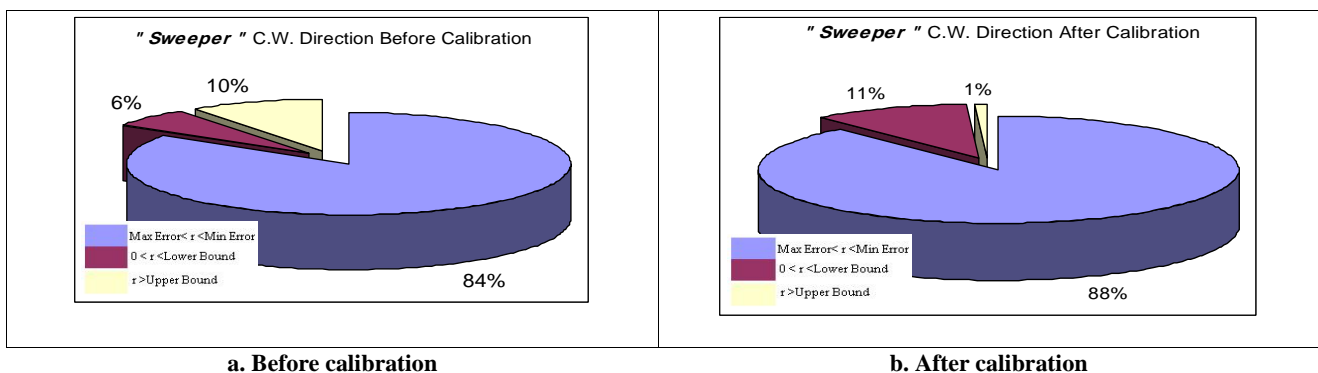

**Fig. 11. Pie chart of error distribution in each category for CW test**

Calibrations solve the problem of systematic error to some extent. None systematic errors have random effect on error distribution. The major causes of remaining errors after calibration are none systematic errors.

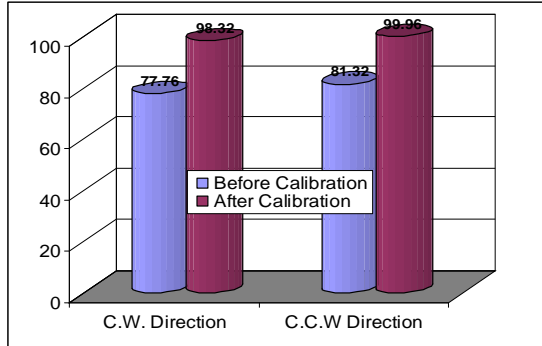

Fig. 12. The comparison of probability of less than 3 cm error from mean error

#### 6-4. Experimental Test and Statistical Analyses in Tracking Circles

For conducting this test for the Sweeper robot and analyzing the results statistically, the following model can be used for the robot. According to the Fig. 13, a differential drive robot will track any path with any radius (the radius domain is limited according to the robot dimension) at the result of different angular velocity in left and right wheel. There are various parameters which affect the resulted path radius. There are as follows:

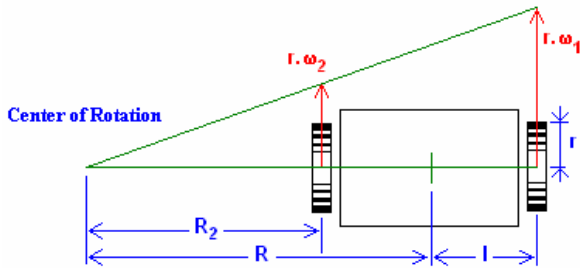

Fig. 13. The robot model in turning

##### a. Controllable Parameters:

1. Left wheel angular velocity
2. Right wheel angular velocity

##### b. Non-controllable Parameters:

1. Difference between nominal and actual right wheel radius
2. Difference between nominal and actual left wheel radius
3. Wheels miss-alignment
4. Difference between nominal and actual distance between right wheel and left wheel
5. Slip between wheels and floor

In the following test, the robot is programmed to track a circle with a desired radius. As it is shown in Fig. 13, the path radius is calculated as follows:

$$R = \frac{l(\omega_1 + \omega_2)}{(\omega_1 - \omega_2)} \quad \text{or,} \quad R = \frac{l(\alpha + 1)}{(\alpha - 1)} \quad (9)$$

where,  $\alpha = \frac{\omega_1}{\omega_2}, \alpha > 1$

R: Path radius of robot center

$\omega_1$ : Angular velocity of motor 1 (Right wheel motor)

$\omega_2$ : Angular velocity of motor 2 (Left wheel motor)

l: Distance between wheel and robot centre which is 88 mm.

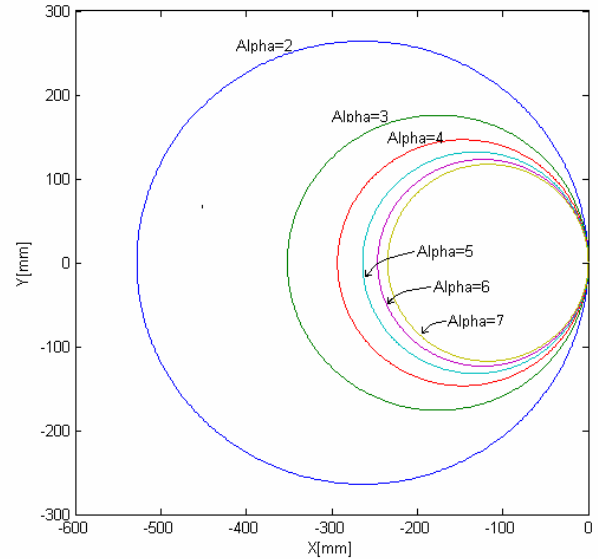

Fig. 14. The ideal robot path according to  $\alpha = 2, 3, \dots, 7$

Also, according to the robot dimensions and gear box ratio, the number of pulses for left motor which is required for the related  $\alpha$  in tracking a complete circle will be calculated as follows:

$$R_2 = R - l \quad (10)$$

$$R_2 = \frac{l(\alpha + 1)}{(\alpha - 1)} - l = \frac{2l}{(\alpha - 1)} \quad (11)$$

where,  $R_2$  is a path radius of left wheel according to related  $\alpha$

$$P_2 = 2\pi R_2 \quad (12)$$

$$P_2 = 2\pi \times \frac{2l}{(\alpha - 1)} \quad (13)$$

$P_2$ : The path length that left wheel passes according to related  $\alpha$  in a complete circle

Also, the length that each will track at the result of one pulse is:

$$L = r \times \frac{1.8}{\beta} \times \frac{\pi}{180} = \frac{r\pi}{100\beta} \quad (14)$$

where,

**L**: The length that each wheel tracks at the result of one pulse

**r**: Wheel radius which for Sweeper is 75mm

**β**: The gear box ratio which for Sweeper is 4

So, the number of pulse which is required for the robot to track a complete circle is:

$$N = \frac{P_2}{L} = \frac{400l\beta}{r(\alpha-1)} \quad (15)$$

In the conducted tests, the robot is programmed to track different circles according to different  $\alpha$  (Fig.14), and its position is measured at the end of the path. So, the error is measured and processed statistically. It is assumed that the average of error dispersion is zero with 95% level of significance and we try to prove it according to the results. Otherwise, we try another assumption for a relation between the error average and  $\alpha$  by using regression analysis. As it is not clear that the error distribution is normal or not, according to Central Limit Theorem, the test is conducted 6 times. As the variance is limited for 6 or more tests, the distribution will be Normal approximately [9].

Test of Hypothesis as 95% level of significance is as follows:

$$\begin{cases} H_0 : \mu_x = 0 \\ H_1 : \mu_x \neq 0 \end{cases} \quad (16)$$

$$\begin{cases} H_0 : \mu_y = 0 \\ H_1 : \mu_y \neq 0 \end{cases} \quad (17)$$

Test of Hypothesis is designed for a normal distribution around 0 for degree of freedom of 5. So the test statistic is calculated as follow:

$$t_x^* = \frac{\frac{\sum_{i=1}^b \bar{x}_i}{b} \sqrt{b}}{\sqrt{\frac{\sum_{i=1}^b (\bar{x}_i - \bar{x})^2}{b-1}}} \quad (18)$$

where,  $\bar{x}_i$  is error average along X according to  $\alpha_i$ .

$$\bar{x} = \frac{\sum_{i=1}^b \bar{x}_i}{b} \quad (19)$$

**b** is a number of different  $\alpha$

Which this test statistic has t-student distribution [10]. Figs. 15 and 16 show the error bar chart along X and Y

axes according to 2, 3, ...,7. The degree of freedom for the test is b-1 which b for our test is 6. The amount of  $t^*$  should be calculated for error which is measured along x and y axes separately to prove the assumption along x and y axes. If the following condition be true, the test of Hypothesis as 95% level of significance will be acceptable:

$$-t_{\frac{1-\delta}{2}, b-1} \leq t_x^* \leq t_{\frac{1-\delta}{2}, b-1} \quad (20)$$

$$-t_{\frac{1-\delta}{2}, b-1} \leq t_y^* \leq t_{\frac{1-\delta}{2}, b-1} \quad (21)$$

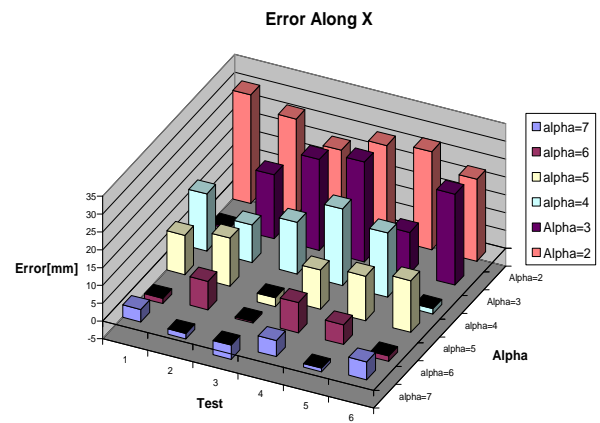

Fig. 15. Error bar charts along X axis according to  $\alpha = 2,3,\dots,7$

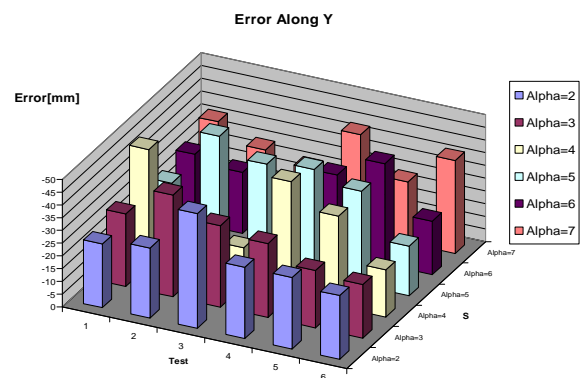

Fig. 16. Error bar charts along Y axis according to  $\alpha = 2,3,\dots,7$

where the percent point,  $t_{\frac{1-\delta}{2}, b-1}$  for 95% as a level of significance and  $b=6$  is equal to 2.571 [10]. According to data in Table 2,  $t_x^*$  and  $t_y^*$  will be as follow:

$$t_x^* = 3.123 \quad , \quad t_y^* = -30.7 \quad (22)$$

Tab. 2. Robot position at the end of the paths

| Test | $\alpha=2$ |       | $\alpha=3$ |       | $\alpha=4$ |       | $\alpha=5$ |       | $\alpha=6$ |       | $\alpha=7$ |       |
|------|------------|-------|------------|-------|------------|-------|------------|-------|------------|-------|------------|-------|
|      | X          | Y     | X          | Y     | X          | Y     | X          | Y     | X          | Y     | X          | Y     |
| 1    | 30.5       | -25   | -0.5       | -28.5 | 16         | -45.5 | 11         | -24   | -1.5       | -27   | 3.5        | -31.5 |
| 2    | 27         | -27.5 | 18         | -40   | 10.5       | -23.5 | 13.5       | -46.5 | 8          | -24   | -1.5       | -24.5 |
| 3    | 21.5       | -45   | 25.5       | -32   | 14.5       | -15   | -2.5       | -39.5 | -0.5       | -24   | -4         | -21   |
| 4    | 26         | -28   | 28         | -29   | 21.5       | -45   | 11         | -41.5 | 8.5        | -31   | 4.5        | -38.5 |
| 5    | 27.5       | -28   | 11.5       | -22.5 | 18         | -35.5 | 12.5       | -37   | 5.5        | -39.5 | -1         | -24   |
| 6    | 23         | -25   | 25.5       | -21   | -1.5       | -18.5 | 14.5       | -19.5 | -1.5       | -21   | 5          | -36.5 |
| Ave. | 25.92      | -29.8 | 18         | -28.8 | 13.17      | -30.5 | 10         | -34.7 | 3.08       | -27.8 | 1.08       | -29.3 |

As the analyses show that our previous assumption is wrong, we design two other tests of hypothesis according to regression analysis.

$$\begin{cases} H_0: \mu_x = Q_x + P_x \alpha \\ H_1: \mu_x \neq Q_x + P_x \alpha \end{cases} \quad (23)$$

$$\begin{cases} H_0: \mu_y = Q_y + P_y \alpha \\ H_1: \mu_y \neq Q_y + P_y \alpha \end{cases} \quad (24)$$

The parameters in the linear model are as follows [10]:

$$P_x = \frac{\sum_{i=1}^6 (\alpha_i - \bar{\alpha})(\bar{x}_i - \bar{x})}{\sum_{i=1}^6 (\alpha_i - \bar{\alpha})^2} \quad (25)$$

$$Q_x = \bar{x} - P_x \bar{\alpha} \quad (26)$$

$$P_y = \frac{\sum_{i=1}^6 (\alpha_i - \bar{\alpha})(\bar{y}_i - \bar{y})}{\sum_{i=1}^6 (\alpha_i - \bar{\alpha})^2} \quad (27)$$

$$Q_y = \bar{y} - P_y \bar{\alpha} \quad (28)$$

where,  $\bar{\alpha}$  is the average of  $\alpha_i$  and  $\bar{y}_i$  is error average along  $\mathbf{Y}$  according to  $\alpha_i$ .

$$\bar{y} = \frac{\sum_{i=1}^b y_i}{b} \quad (29)$$

Fig. 17 show the error along X and Y. According to Table 2, the parameters in our linear model are as follows:

$$\begin{cases} P_x = -4.92 \\ Q_x = 34mm \end{cases} \rightarrow \bar{x}_i = 34 - 4.92\alpha_i \quad (30)$$

$$\begin{cases} P_y = 0.033 \\ Q_y = -30.3mm \end{cases} \rightarrow \bar{y}_i = -30.3 + 0.033\alpha_i \quad (31)$$

The test statistics of the recent assumptions are  $\mathbf{F}_x^*$  and  $\mathbf{F}_y^*$ , as follows:

$$F_x^* = \frac{6 \sum_{i=1}^6 \frac{(\bar{x}_i - (Q_x + P_x \alpha))^2}{b-2}}{\sum_{i=1}^6 \sum_{j=1}^b \frac{(x_{ij} - \bar{x}_i)^2}{b \times (b-1)}} < F_{1-\delta, b-2, b \times (b-1)} \quad (32)$$

$$F_y^* = \frac{6 \sum_{i=1}^6 \frac{(\bar{y}_i - (Q_y + P_y \alpha))^2}{b-2}}{\sum_{i=1}^6 \sum_{j=1}^b \frac{(y_{ij} - \bar{y}_i)^2}{b \times (b-1)}} < F_{1-\delta, b-2, b \times (b-1)} \quad (33)$$

As level of significance,  $\delta$  is equal to 95%, according to related tables,  $\mathbf{F}_{0.05,4,30}$  is equal to 2.69. According to Table 2,  $F_x^*$  and  $F_y^*$  are as follows:

$$\mathbf{F}_x^* = 0.351, \quad \mathbf{F}_y^* = 0.527 \quad (34)$$

So, according to the regression analysis, the linear model for error with level of significance of  $\delta = 95\%$  is an acceptable estimation of error for  $\alpha$  in the following domain:

$$2 \leq \alpha \leq 7 \quad (35)$$

Fig. 18 shows the dispersion of error along x and y axes:



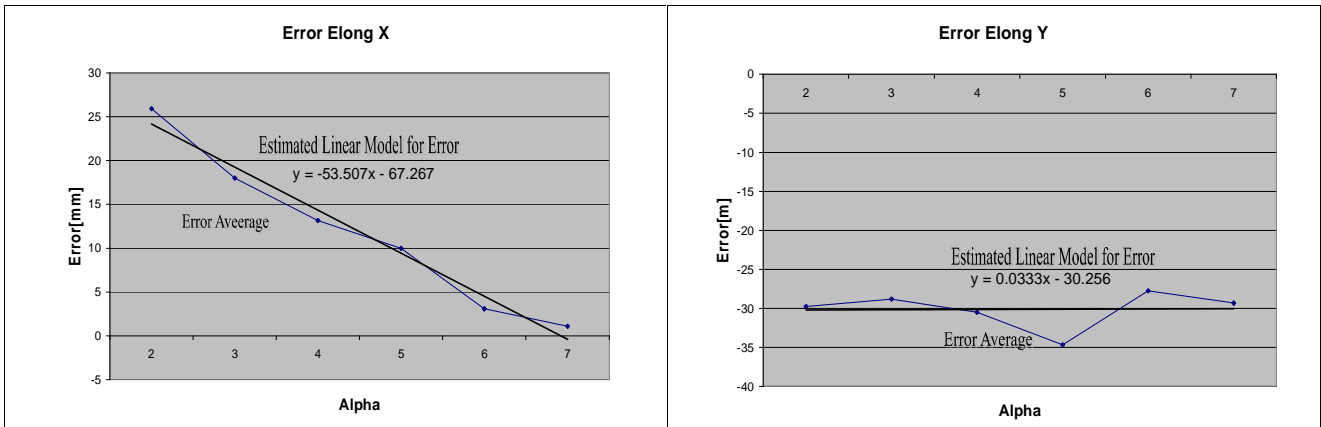

Fig. 17. Error along X and Y axes

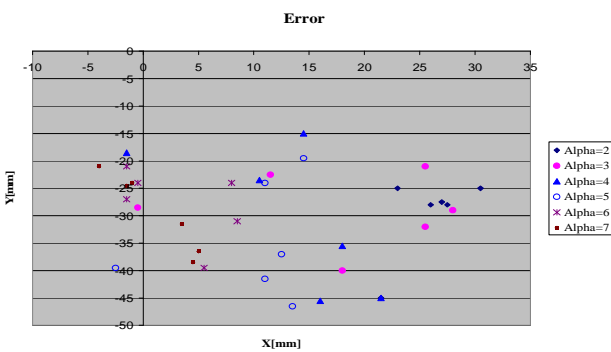

Fig. 18. The Robot positions at the end of the paths

6-5. Experimental Test and Statistical Analyses in Tracking Squares

For conducting this test the Sweeper robot is programmed to track 6 squares with a desired dimension and its errors were measured at the end of the paths. In fact, as it is shown in Fig. 19, the robot tracks 6 squares with different dimensions 6 times and after measuring and analyzing the errors, an error model is presented. The dimensions of the desired squares are  $300\alpha \times 300\alpha$  which  $\alpha = 1, 2, \dots, 6$ .

There are various systematic and non-systematic factors which affect the resulted path. The robot position is measured after passing 4 sides and 4 corners.

In the conducted test, the robot is programmed to track different squares according to different  $\alpha$ , and its position is measured at the end of the path. So, the error is measured and processed statistically. It is assumed that the average of error dispersion is linear with 95% level of significance and we try to estimate the parameters in the linear model and prove the assumption by using regression analysis. In our error model, we try to find a linear relation between  $\alpha$  and error average which is related to that  $\alpha$ . As it is not clear that the error distribution is normal or not, according to Central Limit Theorem, the test is conducted 6 times.

As the variance is limited for 6 or more tests, the distribution will be Normal approximately. [10] Figs. 20 and 21 show the error bar chart along X and Y axes according to  $\alpha = 1, 2, \dots, 6$ . The tests of hypothesis for the errors linear model are the same as Eqs. 23 and 24. Also, the parameters in the linear model can be calculated similarly.

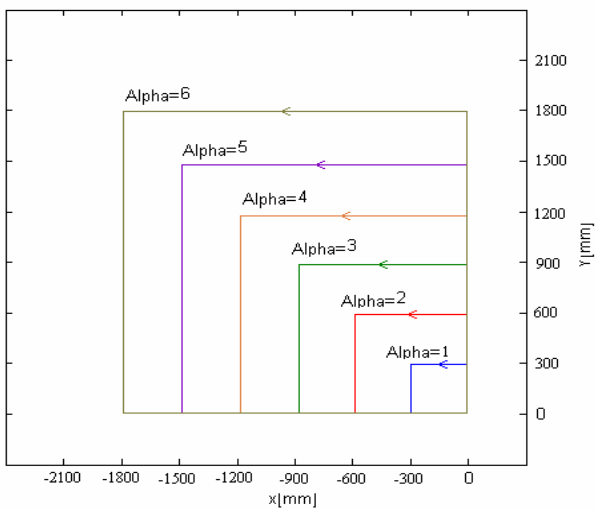

Fig. 19. The ideal robot path according to  $\alpha = 1, 2, \dots, 6$

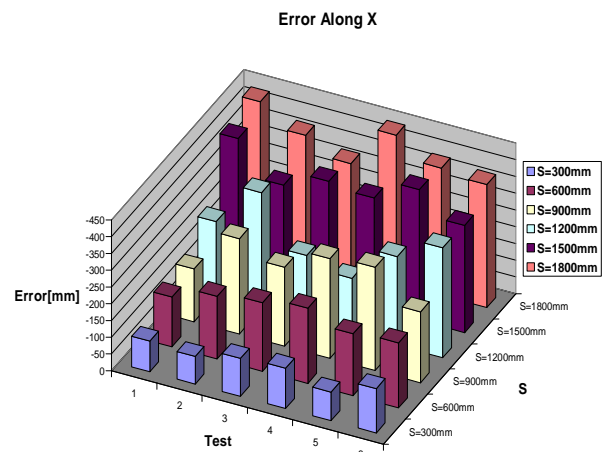

Fig. 20. Error bar charts along X axis according to  $\alpha = 1, 2, \dots, 6$

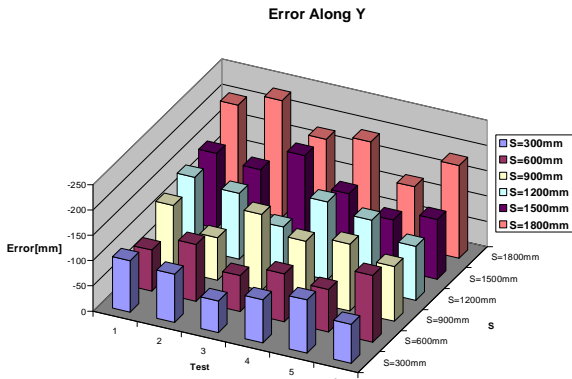

Fig. 21. Error bar charts along Y axis according to  $\alpha = 1, 2, \dots, 6$

So, according to Table 3, the parameters in our linear model are as follows:

$$\begin{cases} P_x = -53.51 \\ Q_x = -67.27mm \end{cases} \rightarrow \bar{x}_i = -67.27 - 53.51\alpha_i \quad (36)$$

$$\begin{cases} P_y = -17.23 \\ Q_y = -64.37mm \end{cases} \rightarrow \bar{y}_i = -64.37 - 17.23\alpha_i \quad (37)$$

Tab. 3. Robot position at the end of the paths

| Test | $\alpha=1, S=300mm$ |        | $\alpha=2, S=600mm$ |        | $\alpha=3, S=900mm$ |        | $\alpha=4, S=1200mm$ |        | $\alpha=5, S=1500mm$ |        | $\alpha=6, S=1800mm$ |        |
|------|---------------------|--------|---------------------|--------|---------------------|--------|----------------------|--------|----------------------|--------|----------------------|--------|
|      | X                   | Y      | X                   | Y      | X                   | Y      | X                    | Y      | X                    | Y      | X                    | Y      |
| 1    | -91.5               | -101.5 | -148.5              | -81    | -157                | -127.5 | -224                 | -142   | -397                 | -147.5 | -432                 | -201.5 |
| 2    | -82.5               | -95    | -187                | -112.5 | -284                | -84    | -346.5               | -130.5 | -294                 | -136   | -368                 | -231   |
| 3    | -113                | -62.5  | -204.5              | -71    | -235.5              | -150.5 | -195.5               | -84    | -342                 | -184   | -320                 | -174.5 |
| 4    | -120                | -85    | -224                | -94.5  | -297.5              | -118   | -164                 | -154   | -328.5               | -128.5 | -441.5               | -189.5 |
| 5    | -85.5               | -105   | -184.5              | -84    | -308                | -132   | -265                 | -138   | -390                 | -97    | -380                 | -121   |
| 6    | -132                | -77    | -194                | -132   | -211.5              | -108   | -328                 | -106.5 | -320                 | -118   | -367                 | -183.5 |
| Ave. | -104.1              | -87.67 | -190.4              | -95.8  | -248.9              | -120   | -253.8               | -125.8 | -345.2               | -135.1 | -384.7               | -183.5 |

According to the results of Table 3 and Eqs. 32 and 33, for the 95% level of significant, the test statistics of the recent assumptions  $F_x^*$  and  $F_y^*$  are as follows:

$$F_x^* = 1.2425, F_y^* = 1.3044 \quad (38)$$

As level of significance,  $\delta$  is equal to 95%, according to the related tables,  $F_{0.05,4,30}$  is equal to 2.69. So, the linear model for error with level of significance

of  $\delta = 95\%$  is an acceptable estimation of error for  $\alpha$  in the following domain:

$$1 \leq \alpha \leq 6 \quad (39)$$

Fig. 22 shows the error along x and y axes and Fig. 23 shows the dispersion of error along x and y axes:

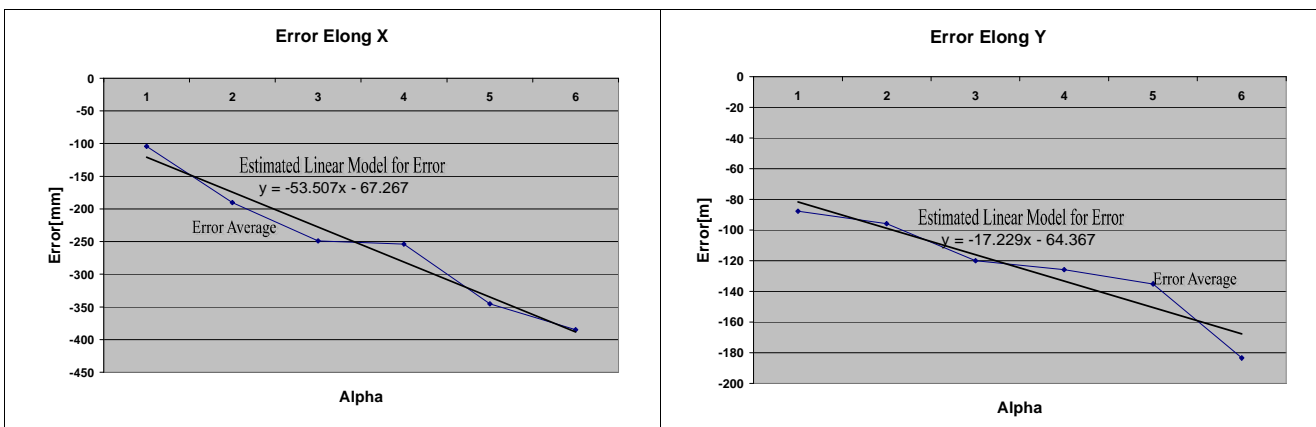

Fig. 22. Error along X and Y axes

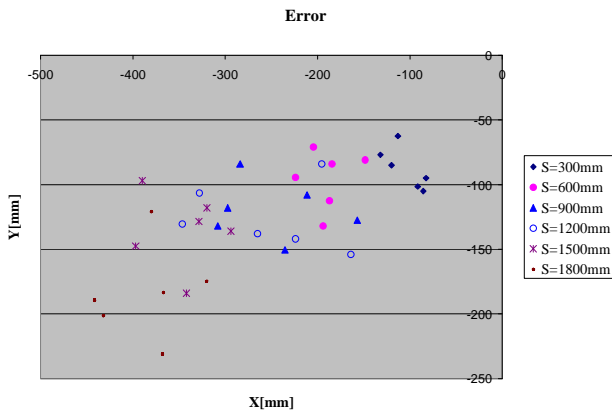

Fig.23. The Robot positions at the end of the paths

**6-6. Error Sources Causing Inaccuracy**

The error sources can be classified into two categories:

**Systematic errors** which are caused by control and mechanical inaccuracy

**Non-Systematic errors** which are caused by environment

**6-6-1. Systematic Error**

Systematic errors are caused by inherent factor in the robot. There are many inaccuracies in mechanical parts. The robot wheels may be unaligned with each other. Also, the elastic band which was used around wheels (for increasing friction between wheels and ground) may cause differences in diameter along a trajectory because of some dynamic forces. Furthermore, the gear box itself cause mechanical errors because of backlash of gears. The resolution of

steps in the step motor affects the accuracy of the robot too. The differences between the results of before and after calibration are because of systematic errors.

**6-6-2. Non-Systematic Error**

There are some errors which are independent from mechanical part, of robot and would happen because of unexpected phenomena. For example in the electrical parts, step motors have slip under sudden torque. In spite of using elastic band around wheels, there are slippage between wheels and floor in fast turning or fast acceleration. These are due to travel over uneven floor or unexpected objects.

**7. Simulation of the Sweeper Robot**

A visual program in MATLAB was developed to model the robot. The visual interface has a link to some m.files and one simulink file. The results appear in various 2D and 3D plots according to the inputs and the desired calculation. Figs. 24-a and 24-b show the result of inverse kinematical problem and compared to the results with experimental tests results for a specific path. The path is composed of two perpendicular straight lines. Length of each line is 1300 mm similar to the previous tests. In the first step, for testing the accuracy of inverse kinematical model, robot was programmed to move according to the results of MATLAB for this path. (8535 pulses in straight line and 1925 in 90degree turn).

In the second step, the results of MATLAB were modified according to calibration formula of previous section and the robot moved according to the calibrated data (Fig 24).

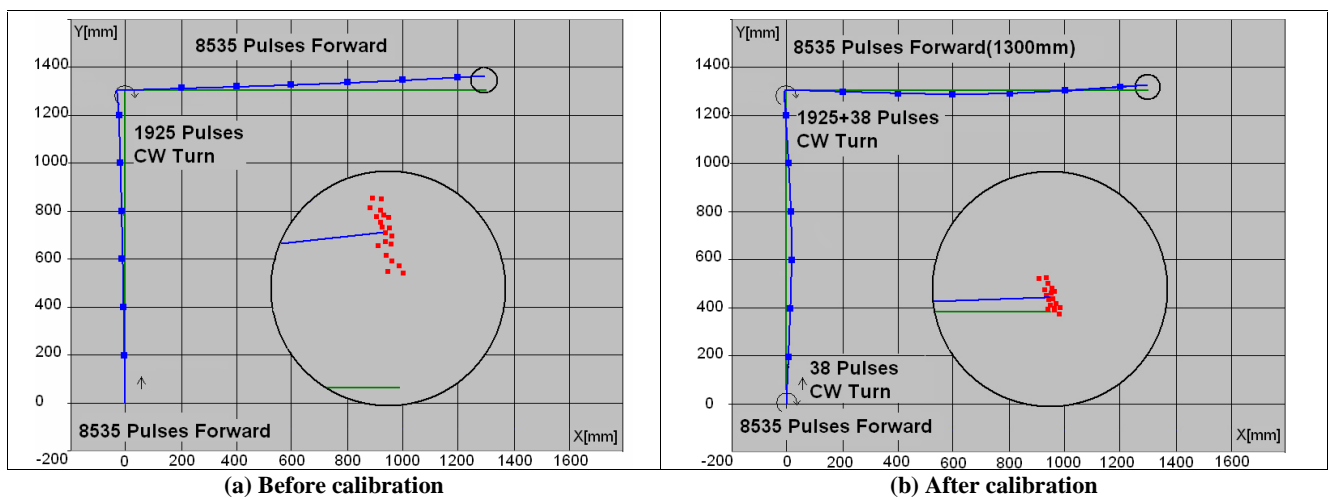

Fig. 24. Comparing MATLAB inverse kinematical model with experimental test

**8. Conclusion**

The **Sweeper Robot** designed for recognizing, picking and placing objects is presented in a situation where the original design of the gripper, which always remains parallel to the ground, is introduced in this paper. In the process of computing the kinematical and dynamical model of the robot, an original approach

was suggested to obtain its inverse kinematical equations. Series of tests are conducted to analyze the sources of error and practical solutions are suggested to decrease the systematic error. Indeed, the results of the tests are analyzed and ultimately it is shown that some calibrations in the robot control software are useful for tracking a trajectory precisely. These calibrations

include adding or subtracting some pulses to the robot program in the desired trajectory. Also two models for error were presented and proven according to the test results.

### References

- [1] Muir, P.F., Neuman, C.P., "*Kinematic Modeling of Wheeled Mobile Robots*", J. of Robotics Syst. Vol. 4, 1987, No. 2, pp. 281-340.
- [2] Alexander, J.C., Moddocks, J.H., "*On Kinematic of Wheeled Mobile Robots*", Int. J. Robotic Research, Vol. 8, 1989, No.5, pp. 15-27.
- [3] Campion, G., Bastin, G., Andrea-Novel, B., "*Structural Properties and Classification of Kinematics and Dynamic Models of Wheeled Mobile Robots*", IEEE Trans. on Robotics & Automation. Vol. 12, 1996, No. 1, pp. 47-62.
- [4] Rajagapalan, R., "*A Generic Kinematic Formulation for Wheeled Mobile Robots*", J. of Robotic Syst., Vol. 14, 1997, No. 2, pp. 77-91.
- [5] Chenavier, F., Crowley, J., "*Position Estimation for a Mobile Robot Using Vision and Odometry*", IEEE Int. Conf. on Robotics and Automation, France, 1992, pp. 2588-2593.
- [6] Borenstein, J., Feng L., "*A Benchmark Test for Measuring odometry Errors in Mobile Robots*", Proceedings of the SPIE Conf. on mobile robots, 1995.
- [7] Borenstein, J., "*The Clapper: A Dual Drive Mobile Robot with Internal Correction of Dead Reckoning Error*", Proceedings of the IEEE Int. Conf. on Robotics and Automation, San Diego, CA, 1994, pp. 3085-3090.
- [8] Korayem, M.H., Nakhaei, A., "*Analysis and Design of Robot for participating in Robo Contest*", Second Int. Manufacturing Leaders Forum (IMLF 2005), Australia, 2005.
- [9] Taguchi, G., "*Introduction to Quality Engineering*", Asian Productivity organization, UNIPUB, White Plains, New York, 1984.
- [10] Bowker, A.H., Lieberman, G.j., "*Engineering Statistics*", Second Edition, Prentice-Hall, 1972.