



OPTIMUM PERFORMANCE-BASED DESIGN OF CONCENTRICALLY BRACED STEEL FRAMES SUBJECTED TO NEAR-FAULT GROUND MOTION EXCITATIONS

B. Ganjavi and I. Hajirasouliha^{1*, †}

¹*Department of Civil Engineering, University of Mazandaran, Babolsar, Iran*

²*Department of Civil and Structural Engineering, University of Sheffield, Sheffield, UK*

ABSTRACT

This paper presents a practical methodology for optimization of concentrically braced steel frames subjected to forward directivity near-fault ground motions, based on the concept of uniform deformation theory. This is performed by gradually shifting inefficient material from strong parts of the structure to the weak areas until a state of uniform deformation is achieved. In this regard, to overcome the complexity of the ordinary steel concentrically braced frames a simplified analytical model for seismic response prediction of concentrically braced frames is utilized. In this approach, a multistory frame is reduced to an equivalent shear-building model by performing a pushover analysis. A conventional shear-building model has been modified by introducing supplementary springs to account for flexural displacements in addition to shear displacements. It is shown that modified shear-building models provide a better estimation of the nonlinear dynamic response of real framed structures compared to nonlinear static procedures. Finally, the reliability of the proposed methodology has been verified by conducting nonlinear dynamic analysis on 5, 10 and 15 story frames subjected to 20 forward directivity pulse type near-fault ground motions.

Keywords: concentrically braced frames; optimum drift distribution; near-fault earthquakes; pushover analysis; simplified equivalent model.

Received: 20 May 2018; Accepted: 10 September 2018

1. INTRODUCTION

Structural and nonstructural damages observed during earthquake ground motions are

*Corresponding author: Department of Civil & Structural Engineering, University of Sheffield, Sheffield, UK

†E-mail address: i.hajirasouliha@sheffield.ac.uk (I. Hajirasouliha)

primarily produced by lateral displacements. Therefore, the estimation of lateral displacement demands is of significant importance in performance-based design methods; specially, when the main quantity of interest is damage control. Nearly all the structures designed based on the common seismic design provisions experience inelastic deformations under severe earthquake ground motions and, thus, their vibration characteristics change significantly. As it was expected, current studies indicate that these design procedures will not necessarily result in a desirable response of structure in the selected performance level [1-4]. Therefore, the employment of such code-compliant height-wise distribution of seismic forces may not lead to the optimum utilization of structural materials. Many experimental and analytical studies have been carried out to investigate the validity of the distribution of lateral forces according to seismic codes [5,6]. One of the most effective optimization techniques was proposed by Moghaddam and Hajirasouliha [4] for shear-building structures with a remarkably improved convergence speed in order to implement uniform ductility criterion for design of shear buildings. They proposed a new load pattern which was also a function of fundamental period of vibration and target inter-story ductility demand of the structure. Using the same concept, Hajirasouliha and Pilakoutas [7] modified the defined constant coefficients associated with this new pattern to incorporate the influence of site effect without soil-structure interaction phenomenon. The most recent work in this field maybe those of Ganjavi and Hao [8,9], and Ganjavi et al., [10] in which they have investigated the effect of soil-structure systems on the efficiency of different lateral load patterns to achieve the equal ductility demands in all stories of elastic and inelastic soil-structure systems. In one of these researches, Ganjavi and Hao [9] developed a new optimization algorithm for optimum seismic design of elastic shear-building structures with SSI effects. Their adopted optimization method was based on the concept of uniform damage distribution proposed by Moghaddam and Hajirasouliha [4] for fixed-base shear-building structures. They proposed a new design lateral load pattern for seismic design of elastic soil-structure systems, which can lead to a more uniform distribution of deformations and up to 40% less structural weight as compared with code-compliant structures. However, their study were based on the results of shear-building structures that may not be applicable for more realistic building structures such as moments-resisting frames and braced frames that are basically designed based on the “strong- column weak-beam” design philosophy. Many researchers made efforts to optimize various structural systems under static and ground motion excitations [11-14]. This study is focused on optimum seismic design of steel concentrically braced frame (SCBF) structures when subjected near-source ground motion excitation through simplified equivalent model which will be discussed in the upcoming section.

Non-linear time history analysis of a detailed analytical model is perhaps the best option for the estimation of deformation demands. However, due to many uncertainties associated with the site-specific excitation as well as uncertainties in the parameters of analytical models, in many cases, the effort associated with detailed modeling and analysis may not be justified and feasible. Therefore, it is logical to have a reduced model, as a simpler analysis tool, to assess the seismic performance of a frame structure. Construction, efficiency and optimization of such reduced models subjected to near-fault ground motions are the main goal of the present study.

For the purpose of preliminary design and analysis of structures, many studies have been

carried out to construct reduced nonlinear models that feature both accuracy and low computational cost. Miranda [15,16] and Miranda and Reyes [17] have incorporated a simplified model of a building based on an equivalent continuum structure consisting of a series of flexural and shear cantilever beams to estimate deformation demands in multi-story buildings subjected to earthquakes. Although in that method the effect of non-linear behavior is considered by using some amplification factors, the flexural and shear cantilever beams can only behave in elastic range of vibration. Some researchers [18-20] have attempted to develop analytical models to predict the inelastic seismic response of reinforced concrete shear-wall buildings, including both the flexural and shear failure modes. Lai et al. [21] developed a multi-rigid-body theory to analyze the earthquake response of shear-type structures. In that work, material non-linearity can be incorporated into the multi-rigid-body discrete model; however, it is impossible to calculate the nodal displacements caused by flexural deformations, which in most cases has a considerable contribution to the seismic response of frame-type structures. Among the wide variety of structural models that are used to estimate the non-linear seismic response of building frames, the conventional shear-building model is the most frequently utilized reduced model. In spite of some of its drawbacks, the conventional shear-building model is widely used to study the seismic response of multi-story buildings mainly due to its excessive simplicity and low computational expenses. This model has been developed several decades ago and has been successfully employed in preliminary design of many high-rise buildings [22-24]. The reliability of conventional shear-building models to predict non-linear dynamic response of moment resistance frames is investigated by Diaz et al. [25]. It has been shown, there, that conventional shear-building models overestimate the ductility demands in the lower stories, as compared with more accurate frame models. This is mainly due to inability of shear-building models to distribute the inelastic deformations among the members of adjacent stories. To overcome this issue, Moghaddam et al., [26] and Hajirasouliha and Doostan [27] improved the conventional shear-building model by introducing supplementary springs to account for flexural displacements in addition to shear drifts. The construction of such reduced model is based on a static pushover analysis. In this study, the reliability of this modified shear-building model is first investigated by conducting non-linear dynamic analysis on 5-, 10- and 15- story concentrically steel braced frames subjected to 20 different near-fault records representing pulse-type forward directivity characteristics. Second, the simplified model is optimized and compared with its real SCBF counterpart. It is shown that the proposed modified shear-building models more accurately estimate the non-linear dynamic response of the corresponding concentrically braced frames compare to the conventional shear-building models subjected to the near-fault ground motions.

3. STEEL CONCENTRICALLY BRACED FRAMES AND NEAR-FAULT GROUND MOTIONS

In the this study, three different 2D steel concentrically braced frame (SCBF) models with 5, 10 and 15 stories have been considered. The 2D geometry of the selected models is shown in Fig. 1. The buildings are assumed to be located on a soil type D Based on ASCE/SEI 7-16 [28]. To prevent the transmission of any moment from beams to the supporting columns

simple beam to column connections are considered. The frame members are sized to support gravity and lateral loads determined in accordance with the minimum requirements of ASCE/SEI 7-16 [28]. In all models, the top story is 25% lighter than the others. IPB, IPE and UNP sections, according to DIN standard, are chosen for columns, beams and bracings, respectively [26]. All joint nodes at the same floor were constrained together in the horizontal direction of the input ground motion. Once the structural members are seized, the entire design is checked for the code drift limitations and if necessary refined to meet the requirements. For the static and non-linear dynamic analysis, the computer program Drain-2DX [29] is used. In time history dynamic analysis, structural damping is modelled based on Rayleigh damping model with 5% of critical damping assigned to the first mode as well as to the mode where the cumulative mass participation is at least 95%. Fiber-type element with distributed plasticity in which the location of non-linearity within the elements is computed during the analysis are utilized to model the columns. It should be noted that the brace members are assumed to have elastic-plastic behavior in tension and compression. As suggested by Jain et al. [30], the yield capacity in tension is set equal to the nominal tensile resistance, while the yield capacity in compression is set equal to 0.28 times the nominal compressive resistance.

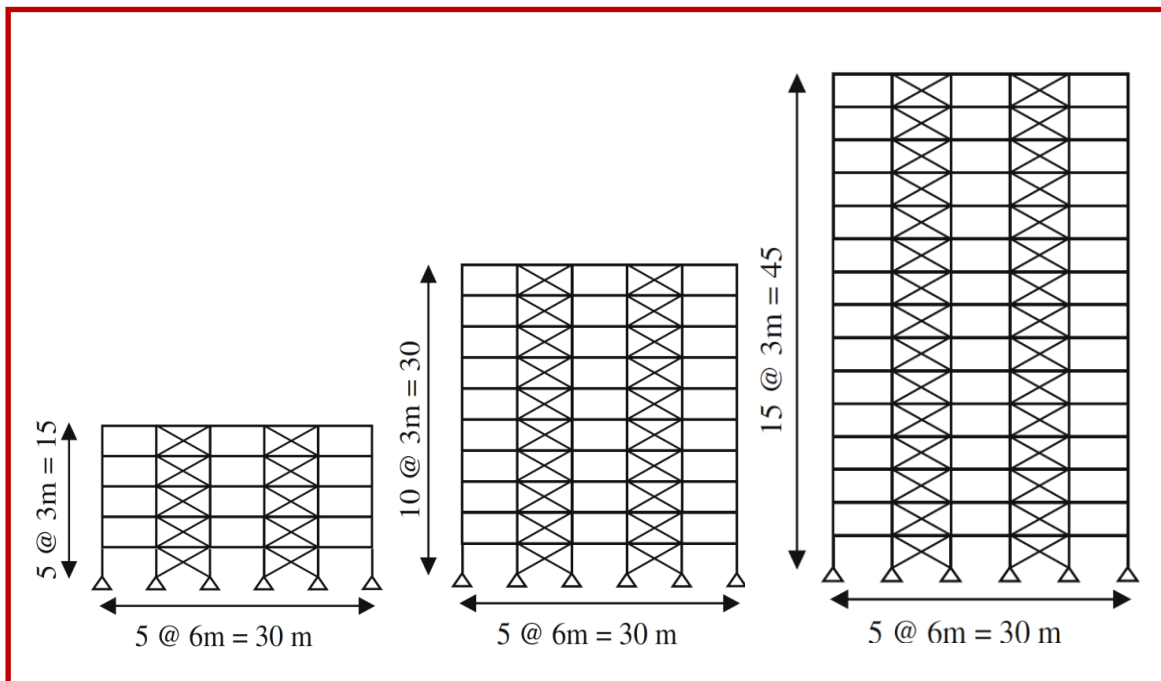

Figure 1. The geometry of 2D SCBF models used in this study

This study is focused on the optimum seismic design of SCBF systems subjected to the fault normal component of near-fault ground motions that exhibit pulse-type characteristics due to forward directivity effects (referred to as forward-directivity near-fault ground motions). For this purpose, a suite of the first 20 forward-directivity near-fault ground motions used by Ruiz-Garcia [31] was assembled. This ground motion ensemble represents a subset of forward-directivity near-fault ground motions that were identified in other studies

[31,32]. Selected acceleration time histories have the following characteristics: (1) recorded at horizontal distances to the surface projection of the rupture not larger than 20 km; (2) recorded in earthquakes with strike-slip or dip-slip faulting mechanisms with moment magnitudes (M_w) equal or larger than 6.0; (3) records with peak ground velocity (PGV) larger than 20 cm/s. In addition, the main characteristics and the period associated with the velocity pulse (i.e., pulse period, T_p) are available for all 20 forward-directivity near-fault ground motions [see Ref. 31]. The pulse period for each ground motion was identified by Fu and Menun [33] using a velocity pulse model fitted to match each of the fault-normal near-fault ground motion components. All the selected ground motions are scaled based on ASCE-7-16 procedure [28].

4. OPTIMUM DESIGN OF CONCENTRICALLY BRACED FRAMES SUBJECTED TO NEAR-FAULT EXCITATIONS

In this section, the full concentrically braced frames are optimized by uniform deformation theory. To do this, the 15-story prototype designed in accordance with ASCE-7-16 code [28], as shown in Fig. 1, are considered and optimized subjected to 20 selected near-fault ground motions such that the maximum shear story drift be minimized. The step by step algorithm and assumptions are summarized as:

- (1) In the optimization process the cross sections of beams and columns remain unchanged and, thus, are not considered as variables in the iterative process. The model already designed for gravitational and ASCE-7-16 [28] lateral load pattern is regarded as an initial pattern for the distribution of structural properties. However, any arbitrary lateral load pattern can be selected as initial lateral load pattern.
- (2) In this case, the cross section area of bracings is assumed to be the only key parameter controlling the structural seismic behavior. Nevertheless, under the combination of gravitational loads the stability of the all columns needs to be checked, which is indeed a stipulating condition for the optimization program. Then, they are resized if necessary to meet the steel design code requirements.
- (3) The prototype is subjected to the given near-fault ground motion; the peak values of shear story drifts, $(\Delta_{sh})_i$, and the average of those values, Δ_{avg} , are computed. Consequently, the coefficient of variation of shear story drifts $COV(\Delta_{sh})$ is calculated. If it is small enough, distribution of bracing strength in each story can be regarded as practically optimum. The average $COV(\Delta_{sh})$ of the first pattern is determined as 0.36. It is found that the COV is high, and the analysis should be continued.
- (4) At this step the distribution of bracing cross section areas, as a parameter monotonically proportional to the shear strength of each story and hence to the total strength of the story, is modified. Based on the optimization algorithm, the inefficient material should be shifted from strong parts to the weak parts to obtain an optimum structure. To accomplish this, the cross section of bracings should be increased in the stories with peak shear story drift greater than the average of peak drifts, Δ_{ave} , and should be decreased in the stories in which the maximum shear drift is less than the average. The total cross section area of the all bracings in the frame is kept unchanged in order for the structural weight of the frame

to be constant. This alteration should be applied incrementally to obtain convergence in numerical calculations. Hence, as proposed by Moghaddam et al., [26], the following equation was used in the present work:

$$[(A_{brace})_i]_{n+1} = [(A_{brace})_i]_n \left[\frac{(\Delta_{sh})_i}{\Delta_{ave}} \right]^\beta \quad (1)$$

where $(A_{brace})_i$ is the total cross section area of bracings at the i th story, n denotes the step number. β is the convergence coefficient ranging from 0 to 1. Results of this study indicate that, for near-fault ground motions an acceptable convergence can be approximately obtained for values of β between 0.1 and 0.15.

(5) Subsequently, cross section areas of the bracings are scaled such that the total structural weight remains constant. Using these modified cross sections, the procedure is repeated from step 2. The $COV(\Delta_{sh})$ of peak shear story drifts for this pattern is expected to be smaller than the corresponding one obtained from the previous step. This procedure is iterated until $COV(\Delta_{sh})$ becomes small enough, and a state of rather uniform shear story drift prevails.

To show the capability of the above optimization algorithm, the average evolution of average shear story drift distribution from the ASCE-7-16 [28] model toward the final optimum distribution is illustrated for 15-story SCBF models. As can be seen, the distributions of the shear story drift along the height in the final step are remarkably uniform and the maximum peak shear story drifts have been decreased from 3.26 to 2.27 cm, meaning 31% reduction in only 4 steps.

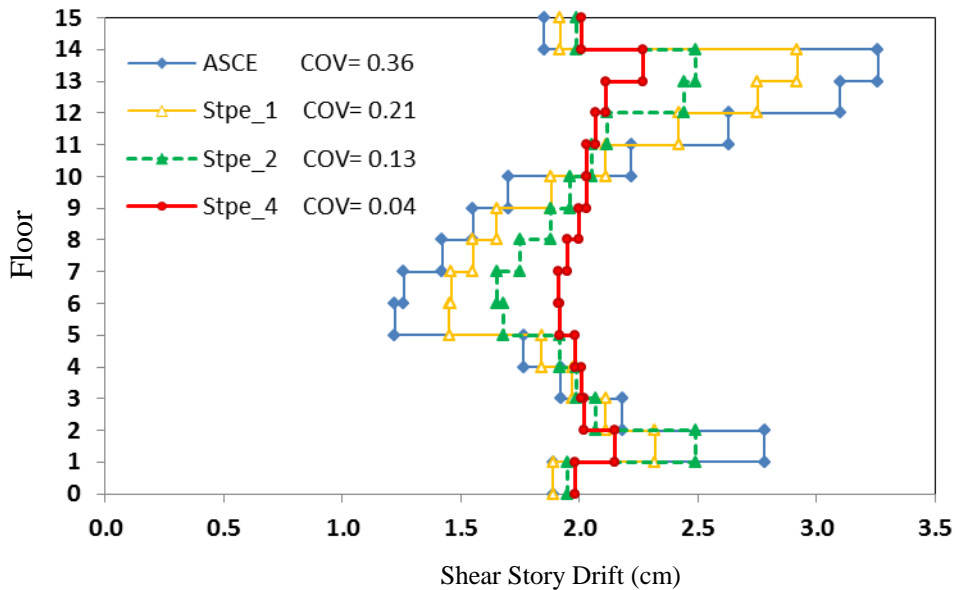

Figure 2. Average shear story drift distribution from the ASCE-7 designed model going toward the final answer; for 15-story SCBF models

4. SIMPLIFIED SHEAR AND FLEXURAL MASS-SPRING MODEL FOR CONCENTRICALLY BRACED FRAMES

In performance-based seismic design method the inter-story drift is considered as a reliable seismic demand parameter that is widely used as a failure criterion due to the simplicity and the convenience associated with its estimation. In fact, most of the recent provisions and guidelines (e.g., FEMA 356 [34]) limit the demand parameters to acceptable values of response, signifying that exceeding of these limits is a violation of a performance objective. Considering the 2-D prototype shown in Fig. 3a, the axial deformation of columns results in increase of lateral story and inter-story drifts. In each story, the total inter-story drift (Δ_i) is a combination of the shear deformation (Δ_{sh}), due to shear flexibility of the story, and the flexural deformation (Δ_{ax}), due to axial flexibility of the lower columns. Hence, the inter-story drift can be expressed as $\Delta_i = \Delta_{sh} + \Delta_{ax}$. It should be noted that flexural deformation has no contribution in the damage imparted to the story, whereas it may impede the stability due to the P- Δ effects. In addition, as depicted in Fig. 3a, Bertero *et al.*, [35] showed that the shear deformation for a single panel when the axial deformation of beams is neglected can be determined by $\Delta_{sh} = \Delta_i + H/2L(U_3 + U_6 - U_2 - U_5)$ where U_5 , U_6 , U_2 and U_3 are vertical displacements, as shown in Fig. 3b. H and L = the height of the story and the span length, respectively. For multi-span models, the maximum value of the shear drift in different panels is considered as the shear story drift.

As described above, lateral deformations in buildings are usually a combination of lateral shear- and flexural-type deformations. However, as mentioned in the literature, in the conventional shear-building models which have been frequently utilized by researchers for parametric studies, the effect of column axial deformations is generally neglected. Therefore, it is not possible to calculate the nodal displacements caused by flexural deformation, while it may have a considerable contribution to the seismic response of most frame-type structures. In the studies carried out by Moghaddam *et al.*, [26] and Hajirasouliha and Doostan [27], the conventional shear-building model, denoted here as SB model, has been modified by introducing supplementary springs to account for flexural displacements in addition to shear displacements. They demonstrated the efficiency of modified shear-building (MSB) model for concentrically braced frame subjected to 15 synthetic far-fault ground motions. In the present study, the efficiency of the MSB model is examined for optimization of SCBF models under pulse-type near-fault ground motions.

4.1 Description of simplified MSB model

Based on the number of stories, the structure is modeled with n lumped masses, representing the stories. Only one degree of freedom (DOF) of translation in the horizontal direction is taken into account and each adjacent mass is connected by two supplementary springs as shown in Fig. 4. As can be observed, the MSB model of a frame condenses all the elements in a story into two supplementary springs, thereby significantly reduces the number of DOFs. The values of supplementary springs stiffness are respectively equal to the shear and bending stiffness values of each story. By enforcing the MSB model to undergo the same displacements as those obtained from a pushover analysis on the original SCBF model the stiffness values can be easily determined. Furthermore, the material nonlinearities may be incorporated into stiffness and strength of additional springs as shown in Fig. 4. In this

figure, m_i is the mass of i th story; and V_i and S_i are, respectively, the total shear force and yield strength of the i th story obtained from the pushover analysis. $(k_t)_i$ is the nominal story stiffness corresponding to the relative total drift at i th floor. $(k_{sh})_i$ is the shear story stiffness corresponding to the relative shear drift at i th floor. $(k_{ax})_i$ represents the bending story stiffness corresponding to the flexural deformation at i th floor, and $(\alpha_t)_i$, $(\alpha_{sh})_i$ and $(\alpha_{ax})_i$ are over-strength factors for nominal story stiffness, shear story stiffness and bending story stiffness at i th story, respectively. $(k_t)_i$ and $(\alpha_t)_i$ are determined from a pushover analysis taking into account the axial deformation of columns. As proposed by Hajirasouliha and Doostan [27], the non-linear force-displacement relationship between the story shear force (V_i) and the total inter-story drift $(\Delta_t)_i$ has been replaced with an idealized bilinear relationship to calculate the nominal story stiffness $(k_t)_i$ and effective yield strength (S_i) of each story (see Fig. 5). Now, by using $\Delta_{sh} = \Delta_t + H/2L(U_3 + U_6 - U_2 - U_5)$, shear story drift corresponding to each step of pushover analysis can be determined and consequently $(k_{sh})_i$ and $(\alpha_{sh})_i$ are calculated. As the transmitted force is equal in two supplementary springs, the expression $\Delta_t = \Delta_{sh} + \Delta_{ax}$ can be rewritten as:

$$\text{For } V_i \leq S_i \Rightarrow \frac{V_i}{(K_t)_i} = \frac{V_i}{(K_{sh})_i} + \frac{V_i}{(K_{ax})_i} \Rightarrow \frac{1}{(K_t)_i} = \frac{1}{(K_{sh})_i} + \frac{1}{(K_{ax})_i} \quad (2)$$

$$\text{For } V_i > S_i \Rightarrow \frac{S_i}{(K_t)_i} = \frac{V_i - S_i}{(\alpha_t)_i (K_t)_i} = \frac{S_i}{(K_{sh})_i} + \frac{V_i - S_i}{(\alpha_{sh})_i (K_{sh})_i} + \frac{S_i}{(K_{ax})_i} + \frac{V_i - S_i}{(\alpha_{ax})_i (K_{ax})_i} \quad (3)$$

Substituting Eq. (4) in Eq. (5), $(k_{ax})_i$ and $(\alpha_{ax})_i$ are obtained as follows:

$$(K_{ax})_i = \frac{(K_{sh})_i (K_t)_i}{(K_{sh})_i - (K_t)_i} \quad (4)$$

$$(\alpha_{ax})_i = \frac{(\alpha_{ax})_i (\alpha_t)_i [(K_{sh})_i - (K_t)_i]}{(\alpha_{sh})_i (K_{sh})_i - (\alpha_t)_i (K_t)_i} \quad (5)$$

For each frame model, all the required parameters of the MSB can be determined by performing only one pushover analysis. By considering P-delta effects in this pushover analysis, the MSB model will be capable to account for P-delta effects as well. The shear inter-story drift, causing damage to the structure, can be separated from the flexural deformation by using the MSB model. This equivalent model takes into account both the higher mode contribution to structural response as well as the effects of material non-linearity; hence, it represents the behavior of real SCBF models more realistically as compared to the conventional SB model [27].

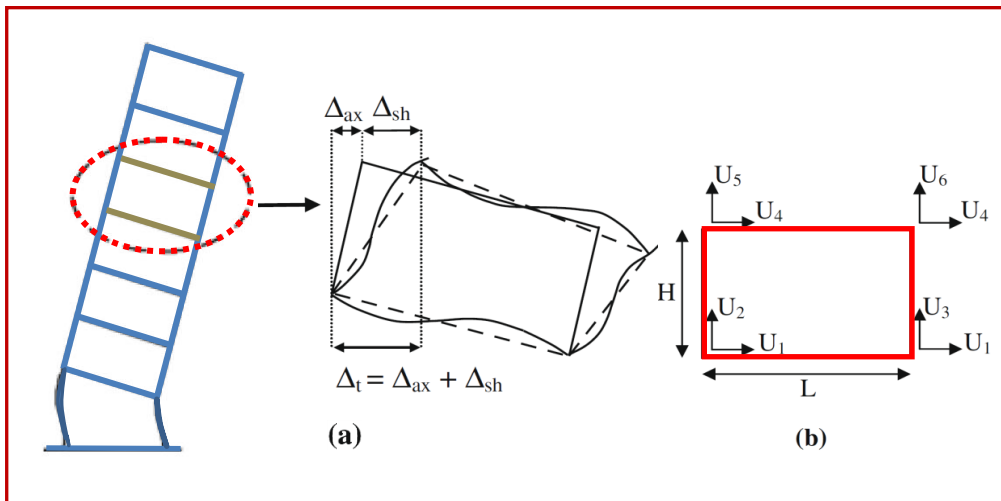

Figure 3. (a) Definitions of total inter-story drift (Δ_t), shear inter-story drift (Δ_{sh}) and the effect of axial flexibility of columns (Δ_{ax}), (b) displacement components of a single panel

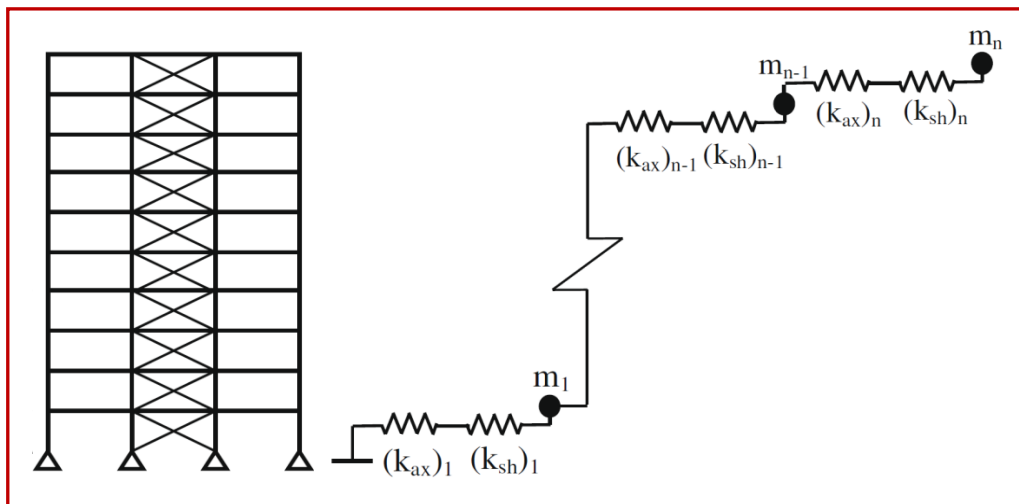

Figure 4. Real concentrically braced frame (left) and modified mass-spring shear-building (MSB) model (right)

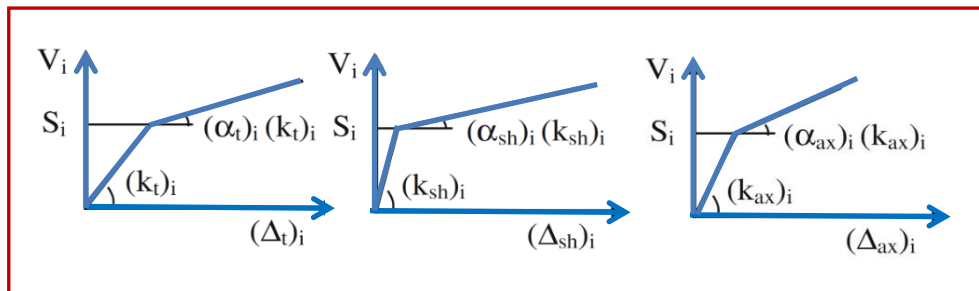

Figure 5. Force-deformation relationship for push over analysis of MSB model

5. EVALUATION OF MSB MODEL TO PREDICT NONLINEAR BEHAVIOR OF SCBF MODELS UNDER NEAR-FAULT EXCITATIONS

To examine the reliability and efficiency of the simplified MSB model in estimating the seismic response parameters of full steel concentrically braced frame (SCBF) model, non-linear time history analyses have been conducted for 5- and 15- story frames and their corresponding equivalent MSB models subjected to 20 near-fault ground motions. Average of the shear and total inter-story drift (Δ_{sh} and Δ_t) for 5- and 15- story full SCBF models and their corresponding MSB models are calculated and compared in Fig. 6. This figure indicates that on average, modified shear-building models are capable to predict total inter-story drift and shear inter-story drift of full SCBF very accurately. In addition, for each near-fault ground motion excitation, the errors in prediction of displacement demands between the simplified MSB and conventional SB model analyses and the corresponding full concentrically braced frames are determined. Subsequently, the average of these errors is computed for every story, and the maximum errors of all frames are computed. It has been found, the maximum errors associated with the MSB model are significantly less than the corresponding values for the conventional SB model, which is more pronounced for inter-story drifts where the errors are almost less than 33% of those estimated by conventional SB models. In general, for MSB models, the maximum errors in all response quantities are only less than 17% which is practically acceptable. This signifies that the displacement demands estimated by MSB models demonstrated to be proper representatives of those obtained based on typical non-linear full concentrically braced frame models of the same structure when subjected to near-fault ground motions. The results are consistent with those reported by Hajirasouliha and Doostan [27] for far-fault ground motions.

6. SEISMIC OPTIMIZATION USING SIMPLIFIED MSB MODEL UNDER NEAR-FAULT EXCITATIONS

It is obvious that a specific relation exists between the stiffness and strength of a story when over-strength is not taken into account. This relation depends on the kinds of structural members and the frame geometry, and can be simply determined by using a pushover analysis. As demonstrated by Moghadam et al., [26] and Hajirasouliha and Doostan [27], the ratios $(k_{ax})_i / (k_{sh})_i$ and $S_i / (k_{sh})_i$ are not dependent on the type of strength distribution pattern. Therefore, $(k_{ax})_i = a_i \cdot (k_{sh})_i$ and $S_i = b_i \cdot (k_{sh})_i$ in which a_i and b_i are constant multipliers and S_i is the shear strength of the i th story, respectively. These parameters can be simply determined by using a pushover analysis.

In the previous section, it has been shown that nonlinear dynamic analysis of full SCBF models requires a great deal of computational effort and, therefore, it would be desirable to utilize the simplified mass-spring MSB models for such analysis instead. In this section seismic optimization algorithm using uniform deformation theory is applied in MSB models when subjected to near fault ground motions and the results in terms of reliability and analysis time compare to the full SCBF models are investigated. The procedure is as follows:

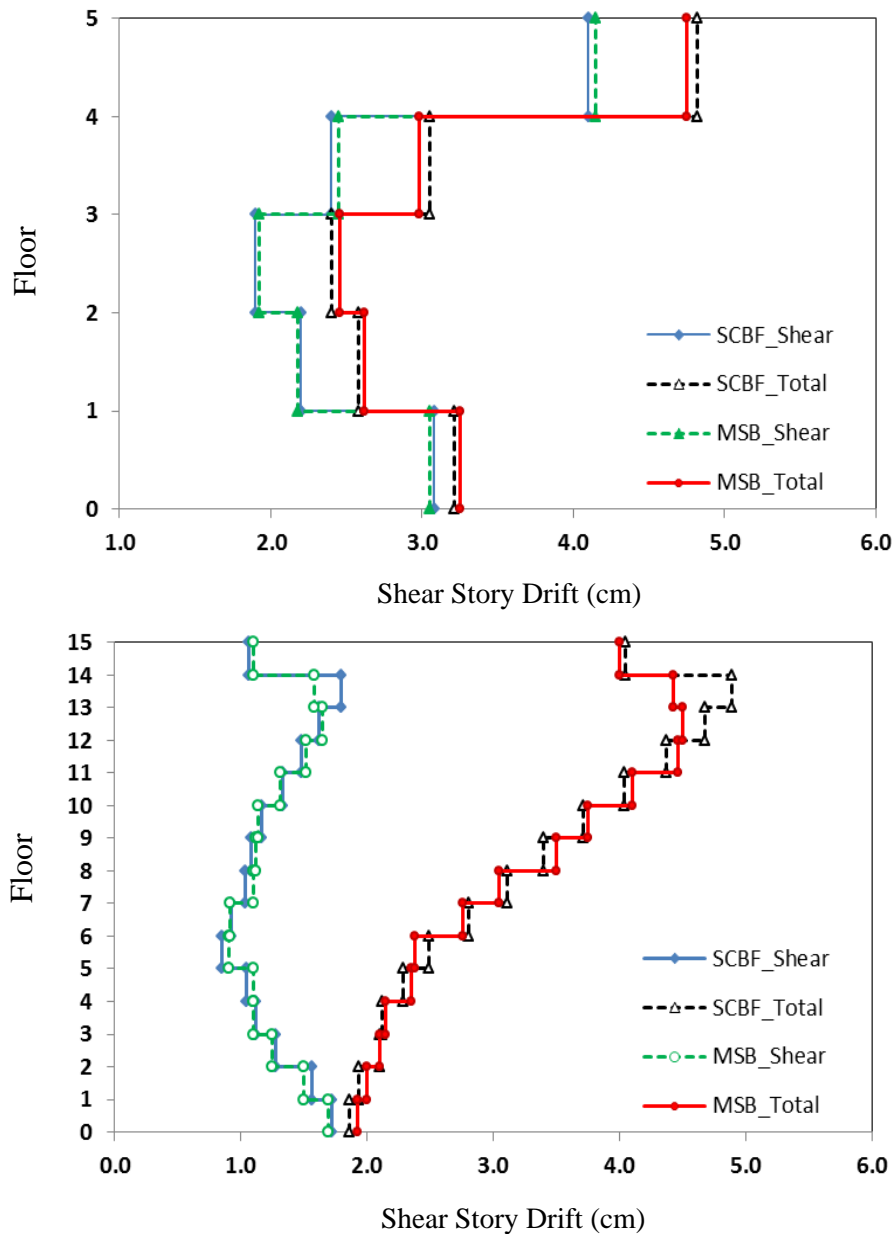

Figure 6. Comparison of the average shear and total inter-story drift demands of full SCBF models and the corresponding MSB model for 5- and 15-story braced frames, average of 20 near-fault earthquakes

1. ASCE-7 Code-compliant or any arbitrary equivalent lateral force is chosen and used for design of structure. Using the procedure discussed above bilinear spring parameters and constant multipliers are determined for each story by conducting a pushover analysis on the designed frame. Then, the corresponding MSB model is generated.
2. A nonlinear time history analysis under a given near-fault earthquake ground motion is performed for the MSB model such that the arbitrary values of strengths, shears and flexural

stiffness satisfying specific relation exists between the stiffness and strength of a story are computed.

3. The average and maximum values of the shear inter-story drifts, (i.e., Δ_{avg}) and $(\Delta_{sh})_i$, are determined, and the corresponding value of $COV(\Delta_{sh})_i$ is calculated. The procedure continues until $COV(\Delta_{sh})_i$ decreases to a prespecified value.
4. To achieve the uniform damage (drift) along the height of the structure, the shear strength, shear stiffness and flexural stiffness of the stories with shear story drifts greater or less than the average drift, (Δ_{avg}) , should be increased or decreased proportionally. The following relationship proposed by Moghaddam et al., [26] has been used to modify the strength parameters for fast convergence:

$$[(K_{sh})_i]_{n+1} = [(K_{sh})_i]_n \left[\frac{(\Delta_{sh})_i}{\Delta_{ave}} \right]^\beta \quad (6)$$

where α is the convergence coefficient chosen as equal to 0.1-0.15 for near-fault excitation. After modifying the story shear stiffness, for each story, the flexural stiffness and strength are modified according to above-mentioned relation existed between the stiffness and strength in each story.

5. In this stage, the parameters $[(ksh)_i]_{n+1}$ and $[(kax)_i]_{n+1}$ are scaled in order to keep the weight of the model constant. The procedure continues until the COV of peak shear story drifts decreases down to a target value. At this stage, the strength distribution is regarded as the optimum.
6. Finally, the optimum lateral load can be calculated from the foregoing optimum strength pattern.

In order to show the capability of using simplified MSB model to optimize full concentrically braced frames subjected to near-fault earthquake ground motions, the above optimization approach is applied to 5- and 15-story models subjected to 20 near-fault earthquakes. For both cases, the code-compliant ASCE-7 [28] designed models have been selected as the initial models without changing the structural weight during the optimization steps. Fig. 7 shows the average results for the steps of optimization approach from the ASCE-7 [28] designed model going toward the final design for 5- and 15-story models subjected to 20 near-fault earthquakes. As can be observed, the convergence efficiency of the MSB models to the optimum design subjected to near-fault earthquakes is highlighted. It is shown that, using the same structural weight, maximum shear story drifts are reduced by almost 45% and 49.5% after only five steps. In addition, the figure shows that reduction of $COV(\Delta_{sh})$ is always accompanied with reduction of the maximum shear story drift, which consistent with previous research conducted by Hajirasouliha and Moghaddam [7], Ganjavi and Hao [9], and Ganjavi et al., [10] where the concept of uniform damage distribution were applied on optimum seismic design of fixed-based and soil-structure shear-building structures.

Based on the above explanation, by using a simplified MSB model, an optimization procedure can be conducted on simple nonlinear mass-spring elements and there is no necessity to conduct any nonlinear dynamic analysis on a full concentrically braced models. Here, to show this point, Fig. 8 is provided in which the final results from the two aforementioned models (simplified MSB and full SCBF models) are compared with ASCE-7 [28] design for the 15-story braced frame subjected to 20 near-fault earthquakes. As

shown, using the MSB model is both simple and accurate enough for design purposes, implying that this equivalent model can be a practical alternative to current design procedures for SCBF models. In another point of view, the ratio of total computational time for optimizing 5-, 10- and 15-story simplified MSB models to their corresponding full steel braced frames under each of 20 near-fault earthquakes along with their average values are compared in Fig. 9. As it is illustrated, the remarkable reduction in the number of degrees of freedom for MSB model results in significant computational savings, while maintaining the accuracy, as compared to the corresponding full SCBF model. According to the results, the total computational time for MSB models are in average less than 4.2%, 3.5% and 2.8% of 5-, 10- and 15-story SCBFs based on full frame models.

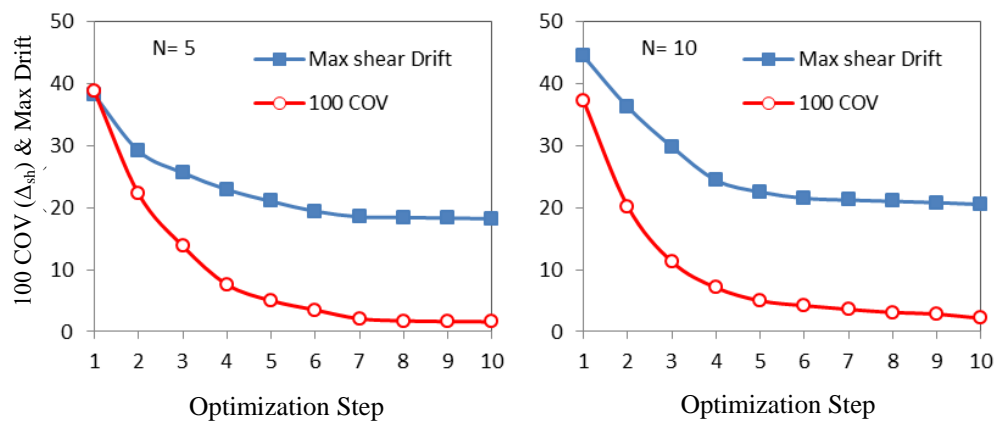

Figure 7. Average $COV(\Delta_{sh})$ and maximum shear inter-story drifts from the ASCE-7 designed model, going toward the final answer; 5- and 10-story braced frame subjected to near-fault earthquakes

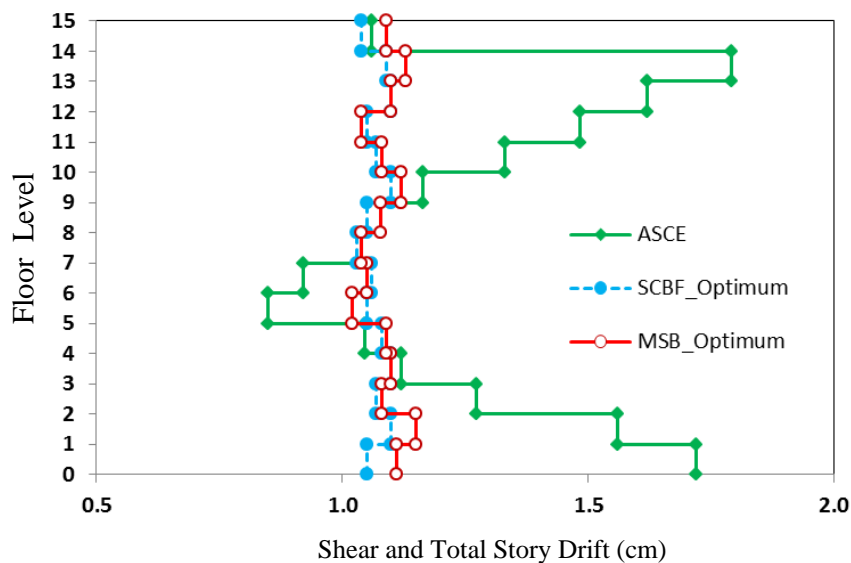

Figure 8. Optimization on the full SCBF model and MSB model compared to the code-compliant ASCE-7 designed for a 5- and 15-story model subjected to 20 near-fault earthquakes

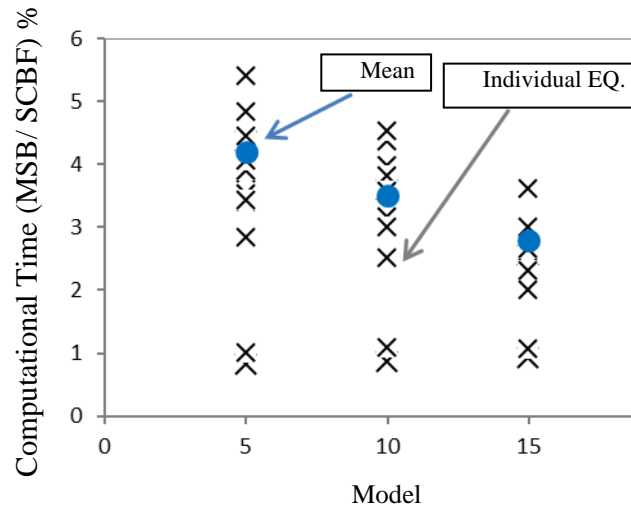

Figure 9. The ratio of total computational time for optimizing 5-, 10- and 15-story simplified MSB models to their corresponding full steel braced frames under each of 20 near-fault earthquakes along with their average values

7. CONCLUSION

In this paper, based on the concept of uniform deformation demands, a practical methodology is proposed for optimization of steel concentrically braced steel frames subjected to forward directivity near-fault ground motions. 5-, 10- and 15-story prototypes designed in accordance with ASCE-7-16 code are considered and optimized subjected to 20 near-fault ground motions such that the maximum shear story drift be minimized. The main findings can be summarized as follows:

- First, the capability of the optimization algorithm is investigated for full SCBF models. the average evolution of average shear story drift distribution from the ASCE-7-16 [28] model toward the final optimum distribution is examined and demonstrated that the distributions of the shear story drift along the height in the final step are remarkably uniform and the maximum peak shear story drifts decreased in average 31% in only 4 steps.
- To overcome the complexity of the ordinary concentrically braced steel frames a simplified analytical model for seismic response prediction of concentrically braced frames utilized. In this approach, a multistory frame is reduced to an equivalent shear-building model by performing a pushover analysis. It is shown that MSB models under near-fault earthquakes have a better estimation of the nonlinear dynamic response of real concentrically braced structures compared to nonlinear static procedures.
- It has been shown that this equivalent MSB model takes into account both the higher mode contribution to structural response as well as the effects of material non-linearity; hence, it represents the behavior of real SCBF models more realistically as compared to the conventional SB model when subjected to forward directivity near-fault earthquakes. The maximum errors associated with the MSB model are significantly less than the

corresponding values for the conventional SB model, which is more pronounced for inter-story drifts where the errors are almost less than 33% of those estimated by conventional SB models. For MSB models, the maximum errors in all response quantities are only less than 17% which is practically acceptable. The results are consistent with those reported by Hajirasouliha and Doostan [27] for far-fault ground motions.

- Utilizing the optimization procedure, assuming the same structural weight, maximum shear story drifts are reduced by almost 50%. The reduction of $COV(\Delta_{sh})$ is always accompanied with reduction of the maximum shear story drift, which is consistent with previous research conducted by Hajirasouliha and Moghaddam [7], Ganjavi and Hao [9], and Ganjavi et al., [10] where the concept of uniform damage distribution was applied on optimum seismic design of fixed-based and soil-structure shear-building structures.
- The remarkable reduction in the number of degrees of freedom for MSB model results in significant computational savings, while maintaining the accuracy, as compared to the corresponding full SCBF model. According to the results, total computational time for MSB models are on average less than 4.2%, 3.5% and 2.8% of those based on full frame models.

REFERENCES

1. Anderson JC, Miranda E, Berto VV. Kajima research team, *Evaluation of the Seismic Performance of Thirty-Story RC Building*, UCB/EERC 91/16, Berkeley, Earthquake Engineering Research Center, University of California, CA, USA, 1991.
2. Hart GC. Earthquake forces for the lateral force code, *Struct Des Tall Buil* 2000; **9**(1): 49-64.
3. Martinelli L, Perotti F, Bozzi A. Seismic design and response of a 14-story concentrically braced steel building, *Behav Steel Struct Seismic Areas* 2000; 327-55.
4. Moghaddam H, Hajirasouliha I. Optimum strength distribution for seismic design of tall buildings, *Struct Des Tall Special Build* 2008; **17**(2): 331-49.
5. Lee SS, Goel SC. Performance based seismic design of structures using target drift and yield mechanism. In: U.S. Japan seminar on advanced stability and seismicity concept for performance based design of steel and composite structures, 2001.
6. Gilmore TA, Bertero VV. Seismic performance of a 30-story building located on soft soil and designed according to UBC 1991. UCB/EERC-93/04, Earthquake Engineering Research Centre, University of California, Berkeley, 1993.
7. Hajirasouliha I, Moghaddam H. New lateral force distribution for seismic design of structures, *J Struct Eng* 2009; **135**(8): 906-15.
8. Ganjavi B, Hao H. A parametric study on the evaluation of ductility demand distribution in multi-degree-of freedom systems considering soil-structure interaction effects, *Eng Struct* 2012; **43**: 88-104.
9. Ganjavi B, Hao H. Optimum lateral load pattern for seismic design of elastic shear-buildings incorporating soil-structure interaction effects, *Earth Eng Struct Dyn* 2013; **42**(6): 913-33.

10. Ganjavi B, Hajirasouliha I, Bolourchi A. Optimum lateral load distribution for seismic design of nonlinear shear-buildings considering soil-structure interaction, *Soil Dyn Earthq Eng* 2016; **88**: 356-68.
11. Kaveh A, Zakian P. Performance based optimal seismic design of rc shear walls incorporating soil–structure interaction using css algorithm, *Int J Optim Civil Eng* 2012; **2**(3) :383-405
12. Kaveh A, Zakian P. Optimal seismic design of reinforced concrete shear wall-frame structures, *KSCE J Civil Eng* 2014; **18**(7); 2181-90.
13. Ganjavi B. Optimal structural weight for flexible-base buildings under strong ground motion excitations, *Asian Civil Eng* 2016; **17**(4): 495-513.
14. Ganjavi B, Ghodrati Amiri G. A comparative study of optimum and iranian seismic design force distributions for steel moment resisting buildings, *Int J Optim Civil Eng* 2018; **8**(2): 195-208.
15. Miranda E. Estimation of maximum inter-story drift demands in displacement-based design, In: Fajfar P, Krawinkler H, editors, *International Workshop on Seismic Design Methodologies for the Next Generation of Codes*, Rotterdam: Balkema; 1997. pp. 253-264.
16. Miranda E. Approximate seismic lateral deformation demands in multistory buildings, *J Struct Eng* 1999; **125**(4): 417-25.
17. Miranda E, Reyes CJ. Approximate lateral drift demands in multistory buildings with non-uniform stiffness, *J Struct Eng* 2002; **128**(7): 840–9.
18. Fajfar P, Gaspersic P. The N2 method for the seismic damage analysis of RC buildings, *Earthq Eng Struct Dynam* 1996; **25**: 31–46.
19. Saiidi M, Sozen MA. Simple nonlinear seismic analysis of RC structures, *J Struct Div ASCE* 1981; **107**(5): 937–52.
20. Hidalgo PA, Jordan RM, Martinez MP. An analytical model to predict the inelastic seismic behavior of shear-wall, reinforced concrete structures, *Eng Struct* 2002; **24**(1): 85-98.
21. Lai M, Li Y, Zhang Ch. Analysis method of multi-rigid-body model for earthquake responses of shear-type structure, In: *WCEE 10th Conference* 1992: pp 4013–4018.
22. Penzien J. Elasto-plastic response of idealized multy-story structures subjected to a strong motion earthquake, In: *WCEE 2nd Conference* 1960.
23. Hisada T, Nakagawa K, Izumi M. Earthquake response of idealized twenty story buildings having various elasto-plastic properties, In: *WCEE 3rd Conference* 1965.
24. Veletsos AS, Vann WP. Response of ground–excited elasto-plastic systems, *ASCE* 1971; **97**(4): 1257–81.
25. Diaz O, Mendoza E, Esteva L. Seismic ductility demands predicted by alternate models of building frames, *Earthq Spectra* 1994; **10**(3): 465–87.
26. Moghaddam H, Hajirasouliha I, Doostan A. Optimum seismic design of concentrically braced steel frames: concepts and design procedures, *J Constr Steel Res* 2005; **61**(2): 151-66.
27. Hajirasouliha I. Doostan. A simplified model for seismic response prediction of concentrically braced frames, *Adv Eng Soft* 2010; **41**: 497-505.
28. ASCE/SEI 7-16. *Minimum Design Loads for Buildings and Other Structures*, American Society of Civil Engineers, Reston VA, 2016.

29. Prakash V, Powell GH, Filippou FC. DRAIN-2DX: Base program user guide. Report No. UCB/SEMM- 92/29, 1992.
30. Jain AK, Goel SC, Hanson RD. Hysteretic cycles of axially loaded steel members, *J Struct Div, ASCE* 1980; **106**(8): 1777-95.
31. Ruiz-García J. Inelastic displacement ratios for seismic assessment of structures subjected to forward-directivity near-fault ground motions, *J Earthq Eng* 2011; **15**(3): 449-68.
32. Baker JW. Quantitative classification of near-fault ground motions using wavelet analysis, *Bulletin Seismolog Society America* 2007; **97**(5): 1486-1501.
33. Fu Q, Menun C. Seismic-environment-based simulation of near-fault ground motions, *Proceedings of the Thirteenth World Conference on Earthquake Engineering* 2004, Vancouver, Paper No. 322.
34. FEMA 356. Prestandard and commentary for the seismic rehabilitation of buildings. Washington (DC): Federal Emergency Management Agency, 2000.
35. Bertero VV, Anderson JC, Krawinkler H, Miranda E. Design guidelines for ductility and drift limits. Report No. UCB/EERC-91/15. University of California, Earthquake Engineering Center, Berkeley, CA, 1991.